

STUDENTS ADJUSTING BINDER ATTACHMENTS AFTER THE ATTACHMENTS HAVE BEEN  
DISMANTLED AND ASSEMBLED



# FARM MACHINERY AND FARM MOTORS

*By*

**J. BROWNLEE DAVIDSON, B.S., M.E.**

*Junior Member American Society of Mechanical Engineers*

*Professor of Agricultural Engineering  
Iowa State College*

**LEON WILSON CHASE, B.S., M.E.**

*Associate Member American Society of Mechanical Engineers*

*Associate Professor of Farm Mechanics  
University of Nebraska*

ILLUSTRATED

NEW YORK

ORANGE JUDD COMPANY

LONDON

KEGAN PAUL, TRENCH, TRUBNER & Co., LIMITED

1908

5615  
J25

LIBRARY of CONGRESS  
Two Copies Received  
FEB 4 1908  
DOWNSIDE COPY  
*Jan 15 1908*  
CLASS A  
196757  
COPY B.

COPYRIGHT, 1908  
By ORANGE JUDD COMPANY

*All Rights Reserved*

---

[ENTERED AT STATIONERS' HALL, LONDON, ENGLAND]



## PREFACE

INSTRUCTION pertaining to Farm Machinery and Farm Motors has been quite recently added to the agricultural course in the majority of the agricultural colleges in the United States. Although the need and importance of such a study was self-evident, it was a new field, one in which the knowledge pertaining to the subject had not been prepared and systematized for instructional purposes. The latest book on the subject of Farm Machinery was written by J. J. Thomas in 1869, before the general introduction of labor-saving machinery for farm work. Many books have been written on the various motors used for agricultural purposes, but it is not believed that an attempt has been made to place in one volume a discussion of them all. The authors have felt the need of a text for instructional purposes, and it is this need that has prompted them to prepare this book. It is a revision of the lecture notes used before their classes for several years. These notes were prepared from a careful study of all the available literature on the subject, and from observation made in the field of the machines at work and in the factories where they are made.

A list of the literature consulted is given at the close of the book. Free use has been made of all this as well as all the trade literature available, and for this an effort has been made to give due credit. Many of the illustrations have been prepared from original drawings by the authors; however, the larger number are those of machines upon the current market.

A discussion of all the farm machines did not seem possible, and attention may be called to the omission of

seed grading and cleaning machinery, cotton machinery, potato machinery, garden machinery, and other classes. The amount of information at hand concerning these classes of machinery did not justify their inclusion. Farm Motors has been made more complete, but some of the motors used to a limited extent in agricultural practice, as hot-air engines and water-wheels, have been omitted. Although electrical machinery is not much used in agriculture, its use is increasing and the interest in the subject has been so general that a chapter on the same has been included. As the efficiency and life of farm machinery depends largely upon the way and manner it is repaired, a short chapter on the Farm Workshop has been added.

To make instruction in Farm Machinery and Farm Motors efficient it should in all cases be supplemented with laboratory and field instruction, and it is not the purpose of this book to displace such instruction.

An attempt has been made to make the material practical, useful and helpful, and although written primarily for a text book, it is hoped that it will be useful to many engaged in practical work.

The authors know that their attempt to prepare a text book has not been perfect, and not only will errors be found in the subject matter, but the material will lack pedagogic form in places. Any criticism or suggestions from instructors in these respects will be duly appreciated. They wish also to acknowledge the obligations they owe many friends for suggestions and aid in many ways. Thanks are due the publishers for their work in preparing the illustrations, which at first seemed to be an almost endless task.

J. B. DAVIDSON.  
L. W. CHASE.

# CONTENTS

## PART I

CHAPTER	PAGE
Introduction . . . . .	I
I. Definitions and Mechanical Principles . . . . .	8
II. Transmission of Power . . . . .	28
III. Materials and the Strength of Materials . . . . .	43
IV. Tillage Machinery . . . . .	51
V. Tillage Machinery (Continued) . . . . .	78
VI. Seeding Machinery . . . . .	102
VII. Harvesting Machinery . . . . .	136
VIII. Haying Machinery . . . . .	162
IX. Manure Spreaders . . . . .	191
X. Threshing Machinery . . . . .	203
XI. Corn Machinery . . . . .	221
XII. Feed Mills . . . . .	234
XIII. Wagons, Buggies, and Sleds . . . . .	241
XIV. Pumping Machinery . . . . .	258
XV. The Value and Care of Farm Machinery . . . . .	277

## PART II

CHAPTER	PAGE
Introduction . . . . .	281
XVI. Animal Motors . . . . .	284
XVII. Windmills . . . . .	298
XVIII. Steam Boilers . . . . .	317
XIX. Steam Engines . . . . .	361
XX. Gas, Oil, and Alcohol Engines . . . . .	401
XXI. Traction Engines . . . . .	436
XXII. Electrical Machinery . . . . .	461
XXIII. The Farm Shop . . . . .	499



# FARM MACHINERY

## PART I

---

### INTRODUCTION

1. One of the requirements for a steady, healthy growth of any people or nation is a bountiful supply of food. The earth can be made to produce in abundance only when the soil is tilled and plants suitable for food are cultivated. As long as the people of the earth roamed about obtaining their subsistence by hunting and fishing, conditions were not favorable for a rapid increase in population or an advance in civilization. Tribes or nations constantly encroached upon each other's rights and were continually at war. History shows that when any nation, isolated so as to be protected from the attacks of other nations, devoted itself to agricultural pursuits, its government at once became more stable and life and property more secure. Protected in this way, a great nation, shut off from the rest of the world by natural means, and located in a fertile country, arose along the banks of the Nile long before any other nation reached prominence. The Gauls became mighty because they devoted themselves to agriculture and obtained in this way a more reliable supply of food. Pliny, the elder, in his writings tells of the fields of Gaul and describes some of the tools used. It has been estimated that there never were more than 400,000 Indians in North America, and they were often in want of food. Compare this number with the present population. The tribes that flourished

and increased in numbers were those who had fields of grain and a definite source of food.

**2. Change from hand to machine methods.**—When people began to turn their attention to farming they began to devise tools to aid them in their work. Various kinds of hoes, crude plows, sickles, and scythes were invented, but were practically all hand tools. Work with these was necessarily very laborious and slow. The hours of labor in consequence were very long, and the social position of the tiller of the soil was low. He was in every sense of the term “the man with the hoe.” He became prematurely old and bent; his lot was anything but enviable.

For more than 3,000 years the farmers of Europe, and in this country until after the Revolutionary War, used the same crude tools and primitive methods as were employed by the Egyptians and the Israelites. In fact, it has been, relatively speaking, only a few years since the change from hand to machine methods took place. In the Twelfth Census Report the following statement is made: “The year 1850 practically marks the close of the period in which the only farm implements and machinery other than the wagon, cart, and cotton gin were those which, for want of a better designation, may be called implements of hand production.”

McMaster, in his “History of the People of the United States,” says: “The Massachusetts farmer who witnessed the Revolution plowed his land with the wooden bull plow, sowed his grain broadcast, and when it was ripe, cut it with a scythe and threshed it out on his barn floor with a flail.” He writes further that the poor whites of Virginia in 1790 lived in log huts “with the chinks stuffed with clay; the walls had no plaster, the windows had no glass, the furniture was such as they themselves had



made. Their grain was threshed by driving horses over it in the open field. When they ground it they used a rude pestle and mortar, or placed it in a hollow of a stone and beat it with another."

**3. Effects of the change.**—At any rate, a great change has taken place and all in little over a half century. This great change from the simplest of tools to the modern, almost perfect implements, has produced a marked effect upon the life of the farmer. He is no longer "the man with the hoe," but a man well trained intellectually.

**4. Physical and mental changes.**—It is not difficult to realize that a great change for the better has taken place in the physical and mental nature of the farmer. It is vastly easier for a man to sit on a modern harvester, watch the machine, and drive the team, than it is to work all day with bended back, scuffling along, running a cradle. How much easier it is to handle the modern crop, though much larger, with the modern threshing machine, where the bundles are simply thrown into the feeder, than to spend the entire winter beating the grain out with a flail. The farmer can now do his work and still have time to plan his business and to think of improvements.

**5. Length of the working day.**—One of the marked effects of the change to modern machinery methods has been a shortening of the length of the working day. When the work was done by hand methods, the day during the busy season was from early morn till late at night. Often as much as 16 hours a day were spent in the fields. Now field work seldom exceeds 10 hours a day.

**6. Increase in wages.**—According to McMaster,\* in 1794 "in the States north of Pennsylvania" the wages of

\*McMaster: "History of the People of the United States," Vol. II., p. 179.

the common laborer were not to exceed \$3 per month, and "in Vermont good men were employed for £18 per year." Even as late as 1849, the wages, according to several authorities, did not exceed \$120 a year. Under present conditions, the farm laborer is able to demand two, three, and even five times as much. In countries where hand methods are still practiced, wages are very low. Men are required to work all day from early morning till late at night for a few cents. In some of the Asiatic countries it is said that men work from four in the morning until nine at night for 14 cents. Women receive only 9 or 10 cents and children 7 or 8 cents.

7. **The labor of women.**—Woman, so history relates, was the first agriculturist. Upon her depended the planting and tending of the various crops. She was required to help more or less with the farm work as long as the hand methods remained. Machinery has relieved her of nearly all field work. Not only this, but many of the former household duties have been taken away. Spinning and weaving, soap-making and candle-making, although formerly household duties, are now turned over to the factory. Butter and cheese making are gradually becoming the work of the factory rather than that of the home. Sewing machines, washing machines, cream separators, and numerous other inventions have come to aid the housewife with her work.

8. **Percentage of population on farms.**—During the change from hand to machine methods there was a great decrease in the percentage of the people of the United States living upon the farms. It has been estimated that in 1800 97 per cent of the people were to be found upon the farms. By 1849 this proportion had decreased to 90 per cent, and according to the Twelfth Census Report it was only 35.7 per cent.

**9. Increase in production.**—Notwithstanding this decrease in the per cent of the people upon the farms, there has been, since the introduction of machinery, a great increase in production per capita. In 1800 it is estimated that 5.50 bushels of wheat were produced per capita; in 1850, according to the Division of Statistics of the Department of Agriculture, production had decreased to 4.43 bushels. This was before the effect of harvesting machinery had begun to be felt. People were leaving the farms and the production of wheat per capita was falling off. The limit with hand methods had been reached. Economists were alarmed lest a time should come when the production would not supply the needs of the people. Through the aid of machinery the production increased to 9.16 bushels per capita in 1880, 7.48 bushels in 1890, and 8.66 bushels in 1900. Perhaps this also shows that the maximum production of wheat per capita with present machinery has been reached. The production of corn has also increased, but the increase is not so marked. The production of corn per capita in 1850 was 25.53 bushels; in 1900 it was 34.94 bushels.

**10. Cost of production.**—Although the cost of farm labor has doubled or trebled, the cost of production has decreased. According to the Thirteenth Annual Report of the Department of Labor, the amount of labor required to produce a bushel of wheat by hand was 3 hours and 3 minutes, and now it is only 9 minutes and 58 seconds. The cost of production, as compiled by Quaintance,\* was 20 cents by hand (1829-30) and 10 cents by machinery (1895-96). It is also stated in the Year Book of the Department of Agriculture for 1899 that it formerly required 11 hours of man labor to cut and cure 1 ton of hay. Now

\*The Influence of Farm Machinery on Production and Labor. Publications of the American Economic Association, Vol. V., No. 4.

the same work is accomplished in 1 hour and 39 minutes. The cost of the required labor has decreased from 83  $\frac{1}{3}$  cents to 16  $\frac{1}{4}$  cents a ton. Not only is it true that machinery has revolutionized the work of making hay, but nearly every phase of farm work has been essentially changed.

**11. Quality of products.**—Machinery has also improved the quality of farm products. Corn and other grains are planted at very nearly the proper time, owing to the fact that machinery methods are so much quicker. By hand methods the crop did not have time to mature. It was necessary to begin the harvest before the grain was ripe, and hence it was shrunken. The grain is obtained now cleaner and purer. It would be difficult at the present time to sell, for bread purposes, grain which had been threshed by the treading of animals over it.

**12. Summary.**—Great changes can be accounted for by the introduction of machine methods for hand methods. For all people this has been beneficial. It has caused the rise of our great nation on the Western Hemisphere. To no class, however, has this change been more beneficial than to the farm worker himself. J. R. Dodge summarized the benefits derived by the farm worker when he wrote: "As to the influence of machinery on farm labor, all intelligent expert observation declares it beneficial. It has relieved the laborer of much drudgery; made his work and his hours of service shorter; stimulated his mental faculties; given an equilibrium of effort to mind and body; made the laborer a more efficient worker, a broader man, and a better citizen."\*

Conditions in America have been very favorable for the development of machinery. We have never had an

\*American Farm Labor in Rept. of Ind. Com. (1901), Vol. XI., p. 111.

abundance of farm labor. The American inventor has surpassed all others in his ability to devise machines. By this machinery the farmer receives good compensation for his services and is able to compete on foreign markets with cheap labor of other countries.

Lastly, it seems conclusive that an agricultural college course is not complete in which the student does not study much about that which has made his occupation exceptionally desirable. It should be an intensely practical study, for under present conditions success or failure in farming operations depends largely upon the judicious use of farm machinery.



## CHAPTER I

### DEFINITIONS AND MECHANICAL PRINCIPLES

**13. Agricultural engineering** is the name given to the agricultural achievements which require for their execution scientific knowledge, mechanical training, and engineering skill.

It has been but quite recently that departments have been organized in agricultural colleges to give instruction in agricultural engineering. The name is not as yet universally adopted, the term farm mechanics or rural engineering being preferred by some. It is hoped that in time "agricultural engineering" will be generally accepted, as it seems to be the broadest and most appropriate term to be given instruction defined as above. Implement manufacturers in Europe have been pleased to call themselves agricultural engineers, and the term is not altogether a new one.

Agricultural engineering embraces such subjects as: (1) farm machinery, (2) farm motors, (3) drainage, (4) irrigation, (5) road construction, (6) rural architecture, (7) blacksmithing, and (8) carpentry.

**14. Farm machinery.**—Part I. of this treatise, after the present chapter of definitions and mechanical principles and chapters on the transmission of power and the strength of materials, will be a discussion of the construction, adjustment, and operation of farm machinery, and will include the major portion of the implements and machines used in the growing, harvesting, and preparing of farm crops, exclusive of those used in obtaining power. These will be considered in Part II. under the title of

Farm Motors. The following definitions and explanations will prove helpful:

15. A force produces or tends to produce or destroy motion. Forces vary in magnitude, and some means must be provided to compare them. Unit force corresponds to unit weight and is the force of gravitation on a definite mass. This unit is arbitrarily chosen and is called the **pound**. The magnitude of all forces, as the draft of an implement, is measured in pounds. Forces also have direction and hence may be represented graphically by a line. For this reason a force is sometimes called a **vector quantity**. Two or more forces acting on a rigid body act as one force called a **resultant**.

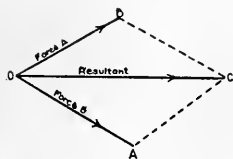

FIG. I

Thus in Fig. 1,  $OA$  and  $OB$  represent in direction and magnitude two forces acting through the point  $O$ .  $OC$  is the diagonal of a parallelogram of which  $OA$  and  $OB$  are sides, and represents the combined action of the forces represented by

$OA$  and  $OB$ , or is the resultant of these forces. This principle is known as the **parallelogram of forces**.

16. **Mechanics** is the science which treats of the action of forces upon bodies and the effect which they produce. It treats of the laws which govern the movement and equilibrium of bodies and shows how they may be utilized.

17. **Work**.—When a force acts through a certain distance or when motion is produced by the action of a force, work is done. Work can therefore be defined as the product of force into distance. Work can be defined in another way as being proportional to the distance through which the force acts, and also to the magnitude of the force.



**18. Unit of work.**—It has been stated that the unit of force is the pound. The unit of distance is the foot. The unit of work is unit force acting through unit distance and is named the **foot-pound**. A foot-pound is then the amount of work performed in raising a mass weighing 1 pound 1 foot. It is to be noted that the amount of work done in raising 1 pound through 10 feet is the same as raising 10 pounds through 1 foot. It is to be noted further that, in considering the amount of work, time is not taken into account. It is the same regardless of whether 1 minute or many times 1 minute was used in performing the operation. The **horse-power hour** is another unit of work commonly used and will be understood after power has been defined.

**19. Power** is the rate of work. To obtain the power received from any source the number of foot-pounds of work done in a given time must be determined. The unit of power commonly used is the horse power.

**20. A horse power** is work at the rate of 33,000 foot-pounds a minute, or 550 pounds a second. That is, if a weight of 33,000 pounds be raised through 1 foot in 1 minute, one horse power of work is being done. This unit was arbitrarily chosen by early steam engine manufacturers to compare their engines with the power of a horse.

If a horse is walking 2.5 miles an hour and exerting a steady pull on his traces of 150 pounds, the effective energy which he develops is:

$$\frac{150 \times 5280 \times 2.5}{60 \times 33000} = 1 \text{ H. P.}$$

**21. A machine** is a device for applying work. By it motion and forces are modified so as to be used to greater advantage. A machine is not a source of work. In fact, the amount of work imparted to a machine always ex-

ceeds the amount received from it. Some work is used in overcoming the friction of the machine. The ratio between the amount of work received from a machine and the amount put into it is called the **efficiency of the machine**.

**22. Simple machines** are the elements to which all machinery may be reduced. A machine like a harvester, with systems of sprockets, gears, and cranks, consists only of modifications of the elements of machines. These elements are six in number and are called (1) the lever, (2) the wheel and axle, (3) the inclined plane, (4) the screw, (5) the wedge, and (6) the pulley. These six may be conceived to be reduced to only two—the lever and the inclined plane.

**23. The law of mechanics** holds that the power multiplied by the distance through which it moves is equal to the weight multiplied by the distance through which it moves. Thus, a power of 1 pound moving 10 feet equals 10 pounds moving 1 foot. This is true in theory, but in practice a certain amount must be added to overcome friction.

**24. The lever**, the simplest of all machines, is a bar or rigid arm turning about a pivot called the fulcrum. The object to be moved is commonly designated as the weight, and the arm on which it is placed is called the weight arm. The force used is designated as the power, and the arm on which it acts is called the power arm. Levers are divided into three classes; for an explanation of the classes refer to any text on physics.\* The law of mechanics may be applied to all levers in this manner. The power multiplied by the power arm equals the weight multiplied by the weight arm.

\*"General Physics." By C. S. Hastings and F. E. Beach and others.

If  $P =$  Power,  $P_a =$  Power arm,  $W =$  Weight, and  $W_a =$  Weight arm,  $P \times P_a = W \times W_a$ .

If three of these quantities are known, the other is easily calculated. The arm or leverage is always the perpendicular distance between the direction of the force and the fulcrum.

25. **The two-horse evener or doubletree.**—The two-horse evener is a lever of the second class where the clevis pin for the whiffletree at one end acts as the fulcrum for

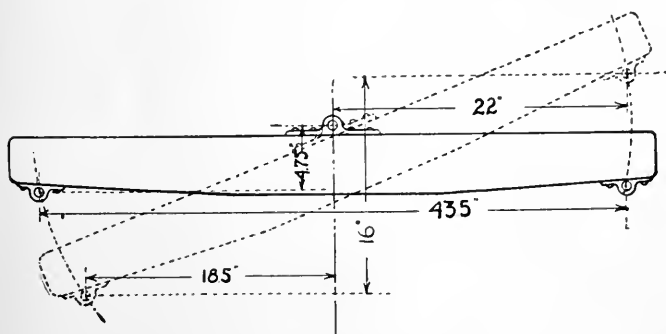

FIG. 2—WAGON EVENER IN OUTLINE. SHOWING THE ADVANTAGE THE LEADING HORSE HAS WHEN THE CLEVIS HOLES ARE NOT A STRAIGHT LINE

the power applied by the horse at the other end. The weight is the load at the middle. If the three holes for the attachment of each horse and the load be in a straight line and the arms be of equal length, each horse pulls an equal share of the load even if the evener is not at right angles with the line of draft. But more often the end holes in the evener are placed in a line behind the hole for the center clevis pin. Then if one horse permits his end of the evener to recede, he will have the larger portion of the load to pull because his lever arm has been short-

ened more than the lever arm of the other horse. The author's attention has been called to a wagon doubletree in which the center and end holes for clevis pins are made by iron clips riveted to the front and back sides of the wood. The center hole was thus placed  $4\frac{3}{4}$  inches out of the line of the end holes. This evener is shown in outline in Fig. 2.

By calculation it was found that if one horse was 8 inches in the advance of the other, the rear horse would pull 8.4 per cent more than the first, or 4.06 per cent more of the total load. If this difference was 16 inches, the rear horse would pull 19 per cent more than the first, or 8 per cent more of the total load.

**26. Eveners.**—When several horses are hitched to a machine as one team, a system of levers is used to divide the load proportionately. The law of mechanics applies in all cases, noting that the lever arm is the perpendicular distance between the direction of the force and the fulcrum or pivot. In general, it may be said that there is nothing to be gained by a complicated evener. If there is a flexible connection and an equal division of the draft, the simple evener is as good as the complicated or so-called "patent" evener. The line of draft cannot be offset without a force acting across it. This is accomplished with a tongue truck, which seems to be the logical method.

Fig. 3 illustrates some good types of eveners.

**27. Giving one horse the advantage.**—It often occurs in working young animals or horses of different weights that it is desired to give one the advantage in the share of work done. This is accomplished by making one evener arm longer than the other, giving the horse which is to have the advantage the longer arm. This may be done by setting out his clevis, setting in the clevis

of the other horse, or placing the center clevis out toward the other horse. The correct division of the load between horses of different sizes is not definitely known, but it is

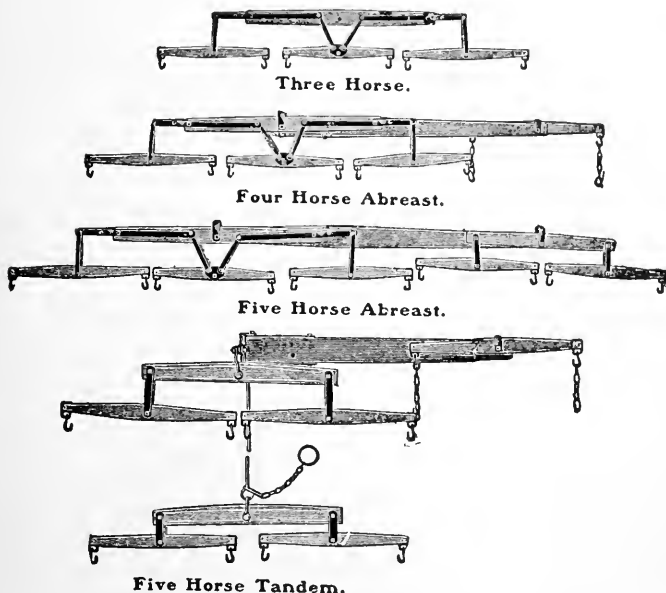

FIG. 3—GOOD TYPES OF EVENERS WHICH WILL DIVIDE EQUALLY THE DRAFT

thought that the division should be made in about the same proportion as each horse's weight is of their combined weight.

28. **Inclined plane.**—The tread power is an example of the utilization of the inclined plane, in which the plane is an endless apron whose motion is transferred to a shaft. The tread power is illustrated in Part II., Farm Motors.

29. **The screw** is a combination of the inclined plane

and the lever, where the inclined plane is wrapped around a cylinder and engages a nut. The **pitch** of a screw is the

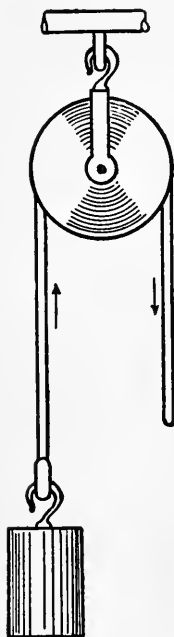

FIG. 4—SIMPLE PULLEY, WHICH ONLY CHANGES THE DIRECTION OF A FORCE

distance between a point on one thread to a like point on the next, or, in other words, it is 1 inch divided by the number of threads to the inch. Thus, 8 threads to 1 inch is  $1/8$  pitch, 24 threads  $1/24$  pitch. There is a great gain of power in the screw because the load is moved a short distance compared with the power. A single-pitch thread advances along the length of the screw once the pitch at each turn; a double pitch advances twice the pitch. The part of a bolt containing a screw thread on the inside is spoken of as a **nut**. The name **burr** is often given to the nut, but **burr** applies more particularly to washers for rivets. The tool used in making the thread in a nut is called a **tap**, and the one for making outside threads a **die**.

30. A **pulley** consists primarily of a grooved wheel and axle over which runs a cord.

A simple pulley changes only the direction of the force. By a combination of pulleys the power may be increased indefinitely. The wheel which carries the rope is called a **sheave**, the covering and axle for the sheave the **block**, and the whole a **pulley**. A combination of blocks and ropes is called a **tackle**. With the common tackle block, the power is multiplied by the number of strands of rope less one.

The mechanical advantage may be obtained in another

way, as it is equal to the number of strands supporting the weight. This will agree with the former method when the power is acting downward. If the power is acting upward instead of downward, the power strand would be supporting the weight, and so should not be deducted from the total number to obtain the mechanical advantage.

Fig. 5 illustrates a tackle which has six strands, but



FIG. 5—A TACKLE. A FORCE MAY BE MULTIPLIED MANY TIMES BY A TACKLE OF THIS KIND



FIG. 6 — DIFFERENTIAL TACKLE BY WHICH HEAVY WEIGHTS MAY BE RAISED

only five are supporting the weight, so the mechanical advantage in this case is five. If the weight be 1,000 pounds, as marked, a force of 200 pounds besides a force sufficient to overcome friction will be needed to raise the weight. This tackle has a special designed sheave which, when the free rope end is carried to one side and let out

slightly, the rope is wedged in a special groove and the weight held firmly in place.

The **differential pulley** shown in Fig. 6 is a very powerful device for raising heavy weights and is very simple. The principle involved is that the upper sheaves are of different diameters, fastened rigidly together and engaging the chain in such a manner as to prevent it from slipping over them. Thus, as the sheaves are rotated, one of the strands of chains carrying the load is taken up slightly faster than the other is let out, shortening their combined length and raising the load.

**31. Dynamometers\*** are instruments used in determining the force transmitted to or from a machine or imple-

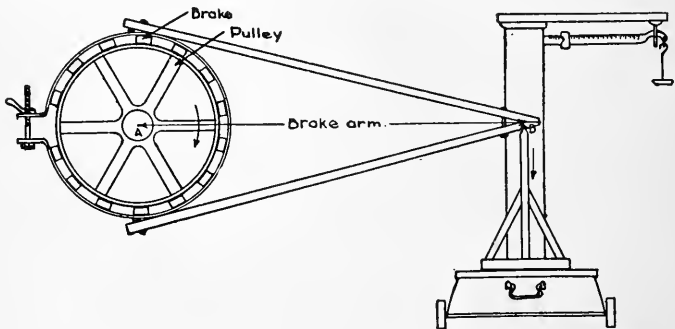

FIG. 7—PRONY BRAKE: ONE FORM OF ABSORPTION DYNAMOMETER

ment. They are, therefore, very important instruments for the study and testing of machinery. Having determined with this instrument the force, it is an easy matter to calculate the power.

**32. Absorption dynamometers** are those which absorb the power in measuring the force transmitted. The **Prony brake** as illustrated in Fig. 7 is the common device used

\*For additional literature on the measurement of power see "Experimental Engineering," by R. C. Carpenter.



in measuring the output of motors. The force transmitted is measured by a pair of platform scales or a spring balance. The distance through which this force acts in 1 minute is calculated from the number of revolutions of the rotating shaft per minute and the distance through which the force would travel in one revolution if released. The revolutions of the shaft are obtained by means of a speed indicator, a type of which is illustrated in Fig. 8.

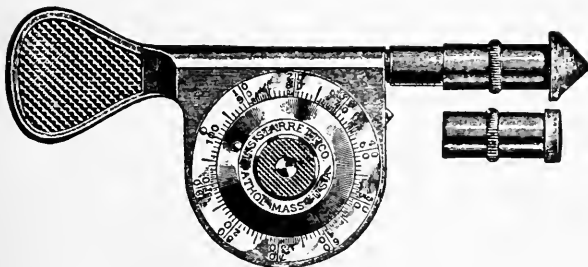

FIG. 8.—SPEED INDICATOR: AN INSTRUMENT FOR DETERMINING THE SPEED

If  $\pi$  = ratio between diameter of circle and the circumference = 3.1416,

$a$  = length of brake arm in feet,

$G$  = net brake load (weight on scale less weight of brake on scale),

$n$  = revolutions a minute,

$$H. P. = \frac{2 \pi G a n}{33000}$$

Dynamometers which do not absorb the power are called **transmission dynamometers**.

**33. Traction dynamometers.**—Dynamometers used in connection with farm machinery to determine the draft of implements are called **traction dynamometers**. They are instruments on the principle of a pair of scales placed between an implement and the horses or engine. They indicate the number of pounds of draft or pull required to move the implement. The traction dynamometer is a transmission dynamometer. The power is not all used

up in the measuring, but transmitted to the implement or machine where the work is being done.

The operation of the traction dynamometer is the same as that of a heavy spring balance. The spring may be a coil, flat or elliptical, or an oil or water piston may be used in place of the spring and the pull determined by the pressure produced.

**34. Direct-reading dynamometers.**—The more simple types of dynamometers have a convenient scale and a needle which indicates the pull in pounds. A second needle is usually provided which shows the maximum pull which has been reached during the test. A dynamometer of this kind is illustrated in Fig. 9. This has

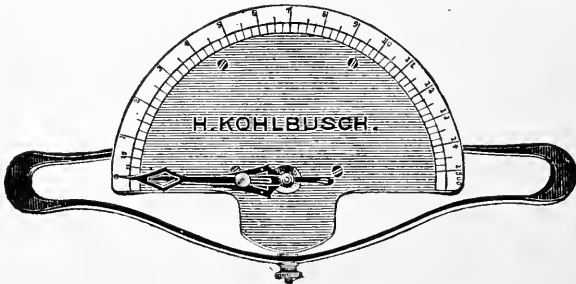

FIG. 9—DIRECT-READING DYNAMOMETER

elliptical springs and a dial upon which the draft is registered. It is difficult to obtain accurate readings from a dynamometer of this sort on account of vibration caused by the change of draft due to rough ground or the unsteady motion of the horse.

**35. Self-recording dynamometers.**—A recording dynamometer records by a pen or pencil line the draft. A strip of paper is passed under the needle carrying the pen point, whose position is determined by the pull. The height of the pen line above a base line of no load is proportional to the pull in pounds. A diagram obtained in

this way is shown in Fig. 10. Often the paper is ruled to scale so that direct readings may be made from the paper. Methods of rotating the reel or spool vary in different makes. Some German dynamometers rotate the

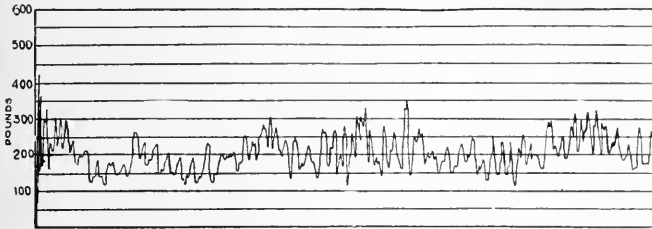

FIG. 10—A RECORD OF DRAFT OBTAINED BY A RECORDING DYNAMOMETER reel by a wheel which runs along on the ground and is connected to the reel by a flexible shaft, as in Fig. 11. This method is very satisfactory, except that the wheel is

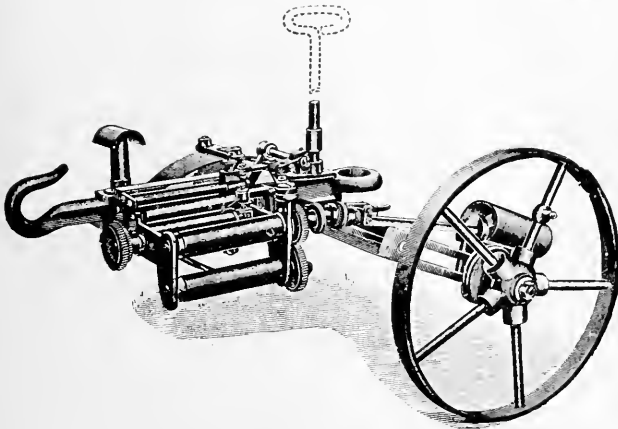

FIG. 11—A GERMAN RECORDING DYNAMOMETER WHICH HAS THE REEL DRIVEN BY CLOCK-WORK

often in the way. Distances along the paper are in this case proportional to the distance passed over by the implement.

Another method is to rotate the reel by clock-work. Then distances along the paper are proportional to time.

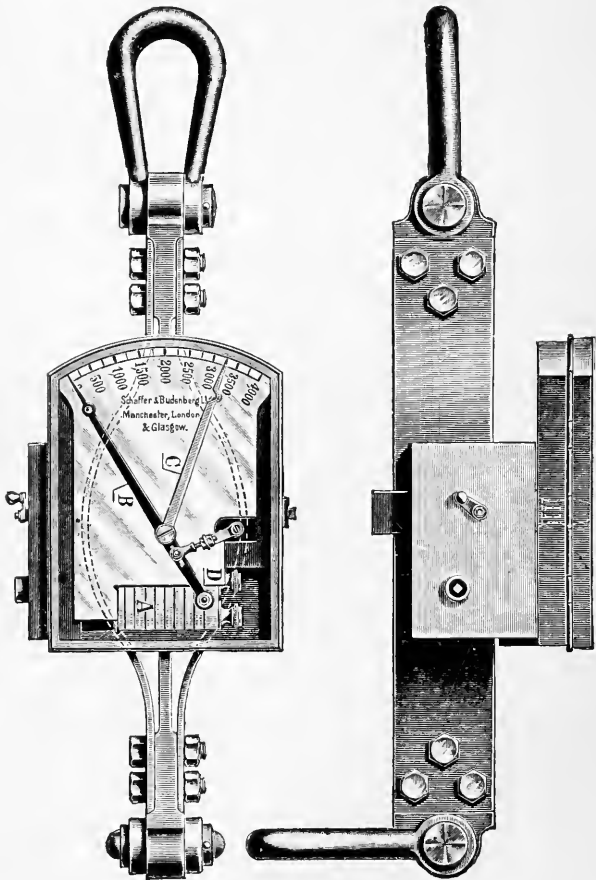

FIG. 12—GIDDINGS RECORDING DYNAMOMETER, WHICH HAS THE REEL DRIVEN BY CLOCK-WORK

If the velocity be uniform, the distances are approximately proportional to the distance passed over as be-

fore. When the distances along the paper are proportional to the ground passed over, the amount of work may be obtained easily. The Giddings dynamometer, as illustrated in Fig. 12, is made in this way. It also has elliptical springs.

Still another method is made use of in another type of dynamometer, in which the in-and-out movement of the pull head is made to rotate the reel. This method is not

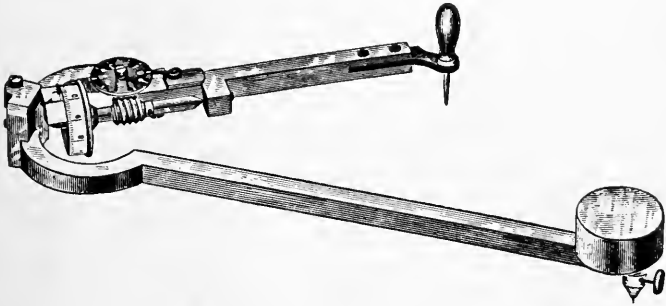

FIG. 13—THE PLANIMETER USED TO FIND THE AVERAGE DRAFT FROM DYNAMOMETER RECORDS. THERE ARE SEVERAL TYPES OF THIS INSTRUMENT

so satisfactory because distances along the paper are not proportional to anything. If the draft remains constant, there is no rotation of the reel at all. Various devices are provided dynamometers to add the draft for stated distances, and in this way obtain the work done. A tape line 100 feet long is sometimes used to rotate the reel of the dynamometer.

To obtain the mean draft a line is drawn through the graph of the pen point, eliminating the sharp points. Then the diagram may be divided into any number of equal parts and the sum of the draft at the center of these divisions divided by the number of divisions. The quotient will be the mean draft.

An instrument called the **planimeter** (Fig. 13) will de-

termine the area of the diagram when the point is passed around it. To obtain the mean height and the average draft it is only necessary to divide the area of the diagram by its length. This can only be done when distances along the paper are proportional to the distance passed over by the implement.

36. **Steam and gas engine indicators.**—The indicator, although not used much in connection with farm engines,

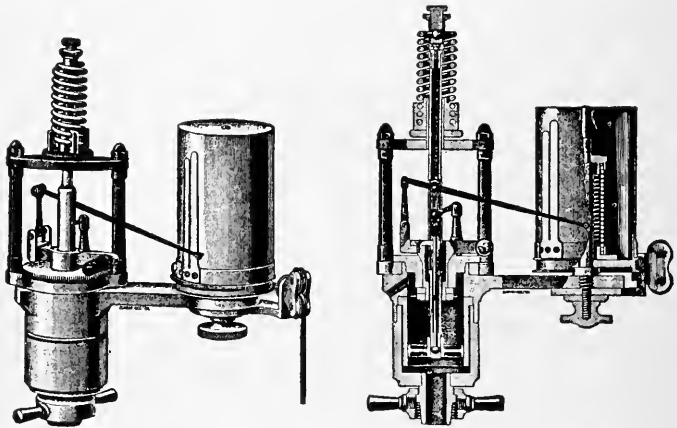

FIG. 14—THE STEAM OR GAS ENGINE INDICATOR. AN INSTRUMENT USED TO OBTAIN A RECORD OF THE PRESSURE IN THE ENGINE CYLINDER AT VARIOUS POINTS OF THE STROKE

should be mentioned at this point under a discussion of the methods of measuring work.

Fig. 14 illustrates a steam engine indicator complete, and also a section of it showing the mechanism inside. In brief, the indicator consists in a drum, upon which a paper card is mounted to receive the record or diagram, and a cylinder carefully fitted with a piston upon which the pressures of the steam or gases from the engine cylinder act. The drum by a mechanism called a **reducing motion** is given a motion corresponding to that of the engine

piston, and the pressure of the gases from the engine cylinder acting on the piston of the indicator compresses a calibrated spring above. The amount of pressure is recorded with a pencil point by a suitable mechanism on the paper card. Thus if a diagram is obtained from an engine at work, it not only permits a study of the engine



FIG. 15—AN ACTUAL INDICATOR DIAGRAM OBTAINED FROM A GAS ENGINE, WITH THE SCALE OF THE SPRING APPENDED

in regard to the action of valves, igniter, etc., but also enables the amount of work performed in the engine cylinder to be calculated.

Fig. 15 shows an actual diagram taken from a gas engine. As the pressure

varies throughout the stroke, an instrument like the planimeter of Fig. 13 must be used to average the pressure for the entire working stroke of the piston, and subtract the pressure required in the preliminary and exhaust strokes. This average pressure is called the mean effective pressure (M.E.P.). Knowing the distance the engine piston travels a minute doing work, the area of the surface on which the pressure acts, and the mean effective pressure, it is possible to calculate the rate of work or the horse power. The horse power obtained in this way is called the indicated horse power (I.H.P.), and differs from the brake horse power (B.H.P.) by the power required to overcome friction in the engine. The ratio of the brake horse power to the indicated horse power is called the mechanical efficiency of the engine.

If  $P$  = Mean effective pressure,  
 $L$  = Length of stroke in feet,  
 $A$  = Area of piston in square inches,  
 $N$  = Number of working strokes a minute,

$$\text{I. H. P.} = \frac{PLAN}{33,000}$$

It is to be noted that in double-acting engines the faces of the piston on which the pressure in the engine cylinder acts differ by the area of the cross section of the piston rod. It is customary to calculate the indicated horse power for each end of the cylinder, and take the sum for the indicated horse power of the engine.

**37. Heat.**—Work, as measured by the foot-pound, is mechanical energy or the energy of motion. Energy is defined as the power to produce a change of any kind and manifests itself in many forms. It may be transformed from one form to another without affecting the whole amount. Heat represents one form of energy, and it is the purpose of all heat engines to transform this heat energy into mechanical energy. Like work, heat may be measured. The unit used for this purpose is the British thermal unit.

The **British thermal unit** (B.T.U.) is the amount of heat required to raise the temperature of 1 pound of water 1° F. To make the unit more specific, the change of temperature is usually specified as being between 62° and 63° F. The work equivalent of the British thermal unit is sometimes called the Joule (J) and is equal to 778 foot-pounds of work.

Thermal efficiency is a term used in connection with heat engines to represent the ratio between the amount of energy received from the engine in the form of work and the amount given to it in the form of heat. The thermal efficiency of a steam engine seldom exceeds 15 per cent and of a gas engine 30 per cent.

**38. Electrical energy.**—By means of a dynamo, mechanical energy may be converted into electrical energy or the energy of an electric current. An electric current may be likened to the flow of water through a pipe in that it has pressure and volume. In the water pipe the pressure



is measured in pounds to the square inch, and the volume by the area of the cross section of the pipe. With an electric current the pressure is measured in **volts** and the volume or amount of current in **amperes**. Thus a current may have a pressure or voltage of 110 volts and a volume or amperage of 7 amperes. The product of volts into amperes gives **watts**. An electrical current of 746 watts is equal to one horse power. Electric energy is bought and sold by the watt-hour, or the larger unit, the kilowatt-hour, which is 1,000 watt-hours.

## CHAPTER II

### TRANSMISSION OF POWER

It is the function of all machines to receive energy from some source and distribute it to the various parts where it will be converted into useful work. This chapter will treat of the devices used in the transmission and distribution of power and the loss of power during transmission.

**39. Belting.**—Belting is one of the oldest and most common devices used for the transmission of power from one rotating shaft to another. The transmission depends upon the friction between the belt and the pulley face; that is, the belt clings to the pulley face and causes it to rotate as the belt travels around it. The sides of a belt, when connecting two pulleys and transmitting power, are under unequal tension. The **effectual tension** or actual force transmitted is the difference between the tensions on each side. The effectual tension multiplied by the velocity of the belt in feet a minute will give the foot-pounds of work transmitted a minute. Thus the power varies directly with effectual tension and the velocity of the belt.

**40. Horse power of a leather belt.**—It is possible to make up a formula with the above quantities to be used in the calculation of the power of a belt or the size required to transmit a certain power. The following is a common rule for single-ply belting, which assumes an effectual tension of 33 pounds an inch of width:

H. P. = Horse power.  
 $v$  = Velocity in feet a minute,  
 $w$  = Width of belt in inches.

$$\text{H. P.} = \frac{v'w}{1000}$$

The quantity  $v$  may be calculated from the number of revolutions a minute and the diameter of the driving pulley. The velocity of belts rarely exceeds 4,500 feet a minute. The highest efficiency of belt transmission is obtained from belting when there is no slipping and little stretching, and when the tension on the belt does not create an undue pressure on the bearings.

**41. Leather belting.**—Good leather belting will last longer than any other when protected from heat and moisture. A good belt should last for 10 to 15 years of continuous service. Best results are obtained when the hair or grain side of the leather is run next to the pulley. When the belt is put on the opposite way, the grain side, which is firmer and has the greater part of the strength of the belt, is apt to become cracked and the strength of the belt much reduced.

**42. Care of leather belts.**—Belts should be occasionally cleaned and oiled to keep them soft and pliable. There are good dressings upon the market, and others that are certainly injurious. Neatsfoot oil is a very satisfactory dressing. Mineral oils are not very satisfactory, as a rule. Rosin is considered injurious, and it is doubtful if it is necessary to use it on a belt in good condition. With horizontal belts it is desirable to have the under side the driving side, for then the sag of the slack side causes more of the belt to come in contact with the pulleys and will prevent slippage to some extent.

**43. Rubber belting.**—Good rubber belting is of perfect uniformity in width and thickness and will resist a greater degree of heat and cold than leather. It is especially well

adapted to wet places and where it will be exposed to the action of steam. Rubber belting, which clings well to the pulley, is less apt to slip and may be called upon to do very heavy service. Although not as durable as leather, it is quite strong, but offers a little difficulty in the making of splices. Rubber belting is made from two-ply to eight-ply in thickness. A four-ply belt is considered the equal of a single-ply leather belt in the transmission of power. All oil and grease must be kept away from rubber belting.

**44. Canvas belting** is used extensively for the transmission of power supplied by portable and traction engines. It is very strong and durable, and is especially well adapted to withstand hard service. When used in the field it is usually made into endless belts. It has one characteristic which bars its extended use between pulleys at a fixed distance, and that is its stretching and contracting, due to moisture changes. Canvas belting, like rubber belting, is made in various thicknesses from two-ply up. A four-ply belt is usually considered the equal of a single leather belt.

**45. Length of belts.**—Length of belts is usually determined after the pulleys are in place by wrapping a tape line around the pulleys. When this cannot be done conveniently, the following approximate rule taken from Kent's Mechanical Engineer's Pocketbook may be used: "Add the diameter of the two pulleys, divide by two, and multiply the quotient by  $3\frac{1}{4}$ , and add the product to twice the distance between the centers of the shafts."

**46. Lacing of belts.**—Lacing with a rawhide thong is the common method used in connecting the ends of a belt. A laced belt should run noiselessly over the pulleys and should be as pliable as any part of the belt. The holes

should be at least five-eighths inches from the edge and should be placed directly opposite. An oval punch is the best, making the long diameter of the hole parallel with the belt. With narrow belts only a single row of holes need be punched, but with wide belts it is necessary to punch a double row of holes.

By oiling or wetting the end of the lace and then burning to a crisp with a match the lacing may be performed

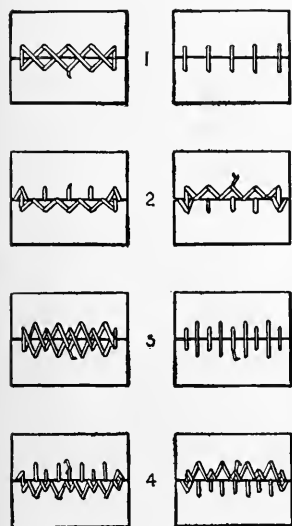

FIG. 16—FOUR GOOD STYLES OF BELT LACING

more easily. Begin lacing at the center of the belt and never cross or twist the lace or have more than two thicknesses of lace on the pulley side of the belt. In lacing canvas belts, the holes should be made with a belt awl. When the lacing is finished it may be pulled through a small extra hole and the lace cut so as to catch over the edge. By this method, tying of the lace is avoided. Fig. 16 illustrates four good methods of lacing a belt with a thong.

1 shows a method of lacing a belt with a single row of holes.

2 shows a light hinge lace for a belt to run around an idler.

3 shows a double row lace.

4 shows a heavy hinge lace.

**47. Wire belt lacing** makes a very good splice. The splice when properly made is smooth and well adapted for leather and canvas belting. When this lacing is used,

the holes should be made with a small punch, the thickness of the belt from the edge and twice the thickness apart. The lacing should not be crossed on the pulley side of the belt.

**48. Pulleys.**—Pulleys are made of wood, cast iron, and steel. They are also constructed solid or in one piece and divided into halves. It is best to have a large cast pulley divided, as the large solid pulley is often weakened by contraction in cooling after being cast. For most purposes the iron pulley is the most satisfactory, as it is neat and durable. Belts do not cling to iron pulleys well, and hence they are often covered with leather to increase their driving power. Often the driving power is increased one-fourth in this way.

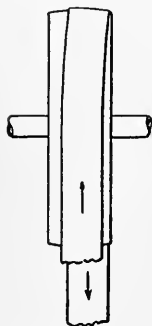

FIG. 17—SHOWING THE EFFECT OF CROWN ON PULLEYS

Pulleys are crowned or have an oval face in order to keep the belt in the center. The tendency of the belt is to run to the highest point, as shown in Fig. 17. The pulley that imparts motion to the belt is called the driver and the one that receives its motion from the belt the driven.

**49. Rules for calculating speed of pulleys.**—Case I. The diameters of the driver and driven and the revolutions per minute of the driver being given, to find the number of revolutions per minute of the driven. Rule: Multiply the diameter of the driver by its r.p.m. and divide the product by the diameter of the driven; the quotient will be the r.p.m. of the driven.

Case II. The diameter and the revolutions per minute of the driver being given, to find the diameter of the driven that shall make any given number of revolutions

per minute. Rule: Multiply the diameter of the driver by its r.p.m. and divide the product by the r.p.m. of the driven; the quotient will be its diameter.

Case III. To ascertain the size of the driver. Rule: Multiply the diameter of the driven by the r.p.m. desired that it should make and divide the product by the revolutions of the driver; the quotient will be the size of the driver.

No allowance is made in the above rules for slip.

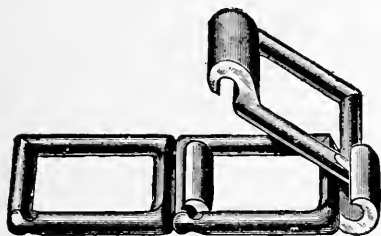

FIG. 18—MALLEABLE LINK BELTING OF ROTATING SHAFTS

A common means of distributing power to various parts of a machine is by link belting. Chain link belting is adapted to almost all purposes except high speed. Two kinds of link belting are now found in general use. One style is made of malleable iron links (Fig. 18) and the other crimped steel (Fig. 19). In regard to the desirability of each, data is not at hand. However, it is stated that the steel links wear longer, but cause the sprockets to wear faster. If this be true, the steel belting should be used on large sprockets and the malleable confined to the smaller sprockets.

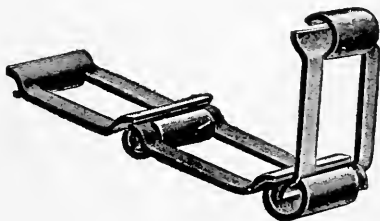

FIG. 19—STEEL LINK BELTING

51. **Rope transmission** often has many advantages over belt transmission in that the first cost of installation is

less, less power is lost by slippage, and the direction of transmission may be easily changed. Transmission ropes are made of hemp, manila, and cotton. Cotton rope is not as strong as the others, but is much more durable, especially when

run over small pulleys or sheaves. The groove of the pulley or sheaves should be of such a size and shape as to cause the rope to wedge into it, thus permitting the effective tension of rope to be increased to its working strength.

Fig. 20 illustrates a rope transmission system. Transmission ropes, to insure the highest efficiency in respect to the amount of power transmitted and the durability of the ropes, should have a velocity of from 3,000 to 4,000 feet a minute. To lubricate the surface of the rope and prevent it from fraying, a mixture of beeswax and graphite is good.

**52. Wire rope or cable transmission.**—For transmission of power to a distance and between buildings, wire rope has many advantages. If the distance of transmission be over 500 feet, relay stations with idler pulleys should be installed to carry the rope. Pulleys or sheaves for wire rope should not have grooves into which the rope may wedge, as this is very detrimental

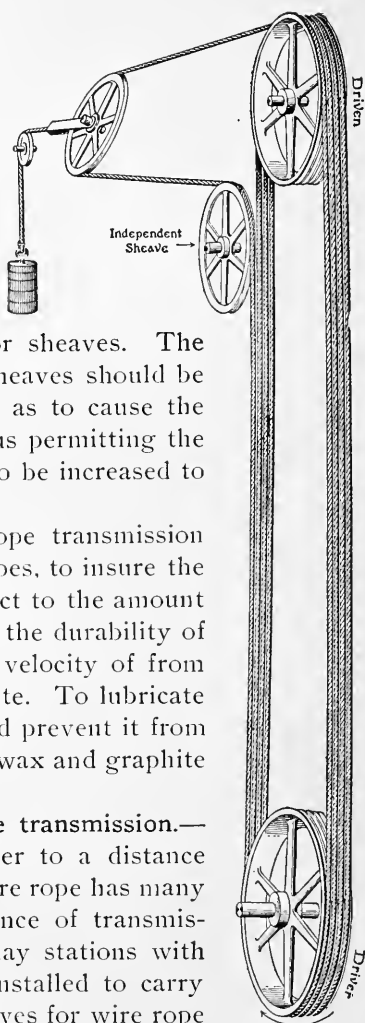

FIG. 20—TRANSMISSION OF POWER BY ROPES



to the durability of the rope. The sheaves for wire rope should have grooves filled with rubber, wood, or other material to give greater adhesion.

Fig. 21 illustrates how a wire rope may be used to transmit power between buildings. For tables useful in



FIG. 21—TRANSMISSION OF POWER BY A WIRE ROPE

determining the size of rope required for a rope transmission, see any engineering handbook. They require too much space to be included in this work.\*

53. **Rope splice.**—To splice a rope the ends should be

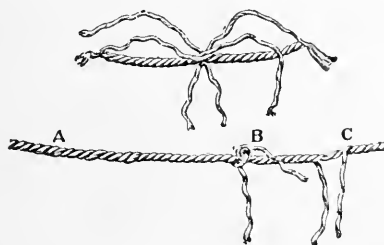

FIG. 22—METHOD OF SPLICING A ROPE

cut off square and the strands unbraided for not less than  $2\frac{1}{2}$  feet and crotched together as shown at I in Fig. 22. After the strands of one end are placed between the strands of the other, untwist one strand as at C and

\*"Mechanical Engineers' Pocket Book." By William Kent.

wind the corresponding strand of the other rope end into its place until about 9 to 12 inches remain. After this is done, the strand should be looped under the other, forming the knot shown at B, with the strand following the same direction as the other strands of the rope. Another strand is now unwound in the opposite direction and the same kind of knot formed. The long ends of the unwound strands are cut to the same length as the short ones, and the short ends woven into the rope by passing over the adjacent strand and under the next, and so on. This is continued until the end of the strand is completely woven into the rope. The same operation is fol-

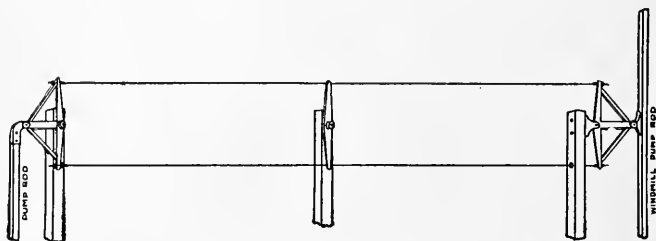

FIG. 23—THE TRANSMISSION OF THE POWER OF A WINDMILL TO A PUMP AT A DISTANCE BY MEANS OF TRIANGLES AND WIRES

lowed with all of the strands until a smooth splice is obtained. The above directions apply well for splicing ropes used with haying machinery. The same method may be used with transmission rope, although with the latter the splice is often made much longer.

**54. Triangles.**—A very handy method of transmitting the power of a windmill to a pump at a distance is by means of triangles, as illustrated in Fig. 23. These triangles are attached to each other by common wire, and, if the distance is great, stations with rocker arms are provided to carry the wires. When triangles are used to connect a windmill to a pump the wires are often crossed

in order that the up stroke of the pump will be made with the up stroke of the windmill.

**55. Gearing.**—Spur gears are wheels with the teeth or cogs ranged around the outer or inner surface of the rim in the direction of radii from the center, and their action is that of two cylinders rolling together. To transmit uniform motion, each tooth must conform to a definite profile designed for that particular gear or set of gear wheels. The two curves to which this profile may be constructed are the involute and the cycloid. Gear wheels must remain at a fixed distance from each other, or the teeth will not mesh properly.

Fig. 24 illustrates some of the common terms used in connection with gear wheels. Bevel gears have teeth

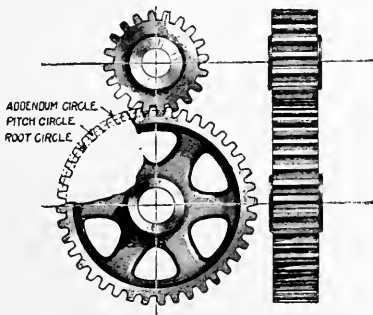

FIG. 24—SPUR GEARING

similar to spur gears, and their action is like that of two cones rolling together.

The teeth of gear wheels are cast or machine cut. Most of the gear wheels found on agricultural machines have the teeth simply cast, as this is the cheaper method of construction. Where smoothness of running is desired, the teeth are machined in, and the form of each tooth is more perfect, insuring smoother action. The

cream separator has machine-cut gears. Very large gear wheels have each tooth inserted in a groove in the gear wheel rim. Such a tooth is called a **cog**; hence the term cog is often applied to all forms of the gear tooth. Cogs may be made of metal or wood.

Like pulleys, gear wheels are spoken of as the driver and the driven. To find the speed ratio of gear wheels, the following rule may be used:

Rule: Revolution of driver per minute, multiplied by the number of teeth in driver, equals the revolution of the driven per minute, multiplied by the number of teeth in driven.

**56. Shafting.**—Where several machines are to be operated from one power unit, it is necessary to provide shafting on which pulleys are placed. Shafting should be supported by a hanger at least every 8 feet, and the pulleys placed as near as possible to the hangers. Thurston gives the following formula for cold-rolled iron shafting:

$$\text{H. P.} = \frac{d^3 R}{55}$$

when H.P. is the horse power transmitted,  $d$  is the diameter of shaft in inches,  $R$  the revolutions per minute. Steel shafting will transmit somewhat more power than iron, and some difference may be made for the way the power is taken from the shaft; but the above rule is considered a safe average.

**57. Friction.**—It has been stated that a machine will not deliver as much energy as it receives because a certain amount must be used to overcome friction. **Friction** is the resistance met with when one surface slides over another. Since machines are made of moving parts, friction must be encountered continually. In the majority of cases it is desired to keep friction to a minimum, but in

others it is required. In the case of transmission of power by belting it is absolutely necessary.

**58. Coefficient of friction** is the ratio between the force tending to bring two surfaces into close contact and the force required to slide the surfaces over each other. This force is always greater at the moment sliding begins. Hence it is said that **friction of rest** is greater than sliding friction.

The following table of coefficients of friction is given to show the effect of lubrication (Enc. Brit.) :

Wood on wood, dry.....	0.25 to 0.5
“ “ “ soaped.....	0.2
Metals on oak, dry.....	0.25 to 0.6
“ “ “ wet.....	0.24 to 0.26
“ “ “ soaped.....	0.2
“ “ metal, dry.....	0.15 to 0.2
“ “ “ wet.....	0.3
Smooth surfaces occasionally lubricated....	0.07 to 0.08
“ “ thoroughly “ ....	0.03 to 0.036

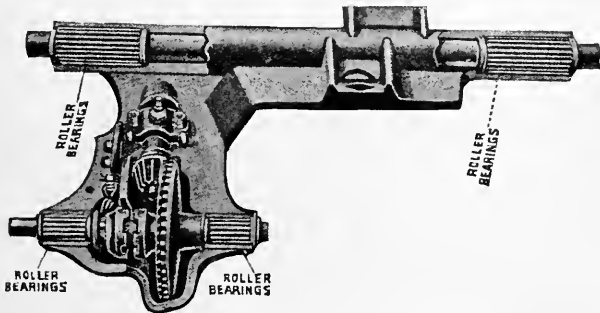

FIG. 25—ROLLER BEARINGS AS APPLIED TO A MOWER

**59. Rolling friction.**—When a body is rolled over a surface a certain amount of resistance is offered. This resistance is termed rolling friction. Rolling friction is due to a slight compression or indentation of the surfaces under the load, hence is much less with hard surfaces

than with soft. Rolling friction is that met with in ball and roller bearings, and is much less than sliding friction. Roller bearings reduce friction greatly. Ball bearings may be used advantageously when end thrust is to be overcome or where they can be used in pairs. They are not suitable for carrying heavy loads.

**60. Lubrication.**—The object of lubrication is to reduce friction to a minimum. A small quantity of oil is placed in a box and a thin film adheres both to the surface of the journal and also to the bearing, so in reality the friction takes place between liquid surfaces. The lubricant also fills the unevenness of the surfaces, so that there is no interlocking of the particles that compose them. Friction with a lubricant varies greatly with the quality of lubricant and the temperature.

**61. Choice of lubricant.**—For heavy pressures the lubricant should be thick so as to resist being squeezed out under the load, while for light pressures thin oil should be used so that its viscosity will not add to the friction. Thus, for a wagon, heavy grease should be used, while for a cream separator of high speed a thin oil is necessary. Temperature must also be taken into account in choosing a lubricant.

Solid substances in a finely divided state, such as mica and graphite, are used to reduce friction. The practice seems to be a very good one. This is especially true with graphite in bearings that can be oiled only occasionally, as the bearings of a windmill.

**62. Bearings** should be of sufficient size that the lubricant will not be squeezed out from between the journal and the bearing. In the design of machinery a certain pressure limit must not be exceeded. It is better to have the journal and bearing made out of different materials, as the friction in this case is less and there is a less ten-

dency for the surfaces to abrade. Brass, bronze, and babbitt are used for bearings with a steel journal. It is highly essential that the bearing be kept free from all dirt and grit. Occasionally it is better to let some minor bearings go entirely without lubrication, for the oil only

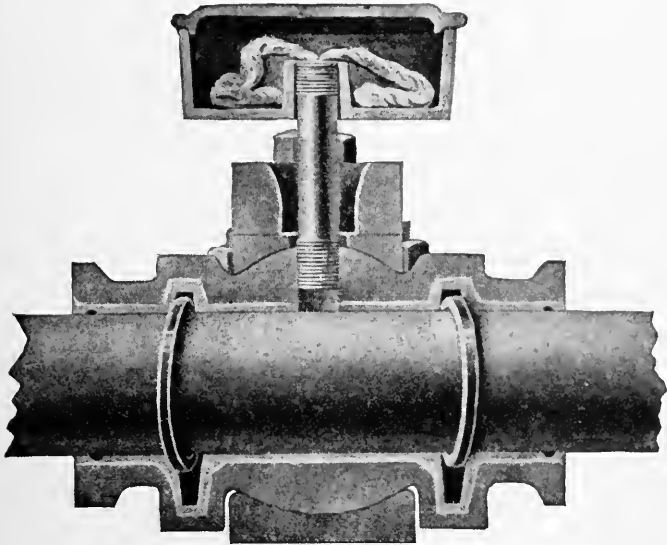

FIG. 26—A SELF-OILING AND SELF-ALIGNING BEARING. OFTEN THE OIL RESERVOIR BELOW THE RINGS IS ENLARGED AND THE WICK DISPENSED WITH

causes the gathering of grit and sand to grind out the bearing.

63. **Heating of boxes** may be due to (1) insufficient lubrication, (2) dirt or grit, (3) the cap may be screwed down too tight, (4) the box may be out of line and the shaft may bind, (5) the collar or the pulley bears too hard on the end, or (6) the belt may be too tight.

Self-oiling boxes are very desirable where they can be

used, as they have a supply of oil which is carried up to the top of the shaft by a chain or ring. It is necessary to replenish the supply of oil only at rather long intervals.

**64. Electrical transmission.\***—Power may be transmitted by converting mechanical energy into electrical energy by the dynamo, and after transmission to a distance be converted into mechanical energy again by the electric motor. This form of transmission has many advantages where the electric current is obtained from a large central station, and no doubt will be an important form of transmission to the farmer of the future, as electric systems are spread over the country for various purposes.

\*See Chapter XXII., Part II.



## CHAPTER III

### MATERIALS AND THE STRENGTH OF MATERIALS

A knowledge of the materials used in the construction of farm machinery and the strength of these materials will be helpful in the study of farm machinery.

**65. Wood.**—At one time farm machinery was constructed almost entirely with wooden framework, but owing to the increase in the cost of timber and the reduction in the cost of iron and steel, it has been superseded largely by the latter. Progress in the art of working iron and steel, making it more desirable for many purposes, has also been a factor in bringing about the substitution of iron and steel for wood. The woods chiefly used in the construction of farm machinery are hickory, oak, ash, maple, beech, poplar, and pine. It is not possible to discuss to any length the properties of these woods. The wood used in the construction of machinery must be of the very best, for there is no use to which wood may be put where the service is more exacting or severe. Wood used in farm machinery must be heartwood and cut from matured trees. It should be dry and well seasoned, and protected by paint or some other protective coating. Moisture causes wood to swell, and for this reason it is difficult to keep joints made of iron and wood tight, for the iron will not shrink with the wood.

Excessive moisture in wood greatly reduces its strength, and wood subjected to alternate dryings and wettings is sure to check and crack. Wood is especially well adapted to parts subject to shocks and vibrations, as

the pitman of a mower. Iron, and especially steel, when subjected to shocks tends to become crystallized. This reduces its strength very much.

**66. Cast iron** is used for the larger castings and most of the gears used in farm machines. At one time cast iron was used to a larger extent than at the present time, as it is being superseded by stronger but more expensive materials. Cast iron is of a crystalline structure and cannot be forged or have its shape changed in any other way than by the cutting away of certain portions with machine tools. Cast iron has a high carbon content, but the carbon is held much as a mechanical mixture rather than in a chemical combination.

**67. Gray iron** is the name applied to the softer and tougher grade of cast iron, which is easily worked by tools; and **white iron** to a very hard and brittle grade. White iron is used for pieces where there are no changes to be made after casting.

**68. Chilled iron.**—When it is desired to have a very hard surface to a casting, as the face of a plow, the inside of a wheel box, or other surfaces subjected to great wear, the iron is chilled when cast by having the molten iron come in contact with a portion of the mold made up of heavy iron, which rapidly absorbs the heat. Chilled iron is exceedingly hard.

**69. Malleable iron** is cast iron which has been annealed and perhaps deprived of some of its carbon, changing it from a hard, brittle material to a soft, tough, and somewhat ductile metal. The process of decarbonation usually consists in packing castings with some decarbonizing agent, as oxide of iron, and baking in a furnace at a high temperature for some time. Malleable iron is much more expensive and more reliable than common cast iron.

70. **Cast steel.**—The term cast steel, as usually applied to the material used in the construction of gears, etc., is cast iron which has been deprived of some of its carbon before being cast.

71. **Mild and Bessemer steel.**—It is from this material that agricultural machinery is largely constructed. The hardness and stiffness of Bessemer steel varies and depends largely upon the carbon content. Steel with a high per cent of carbon (0.17 per cent) is spoken of as a high-carbon steel, and steel with a low per cent (0.09 per cent) low-carbon steel. Bessemer steel is difficult to weld.

72. **Wrought iron.**—Wrought iron is nearly pure iron, and is not as strong nor as stiff as mild steel, but can be welded with greater ease.

73. **Tool steel** is a high-carbon steel made by carbonizing wrought iron, and owing to the carbon content may be hardened by heating and suddenly cooling. Tool steel is used for all places where cutting edges are needed.

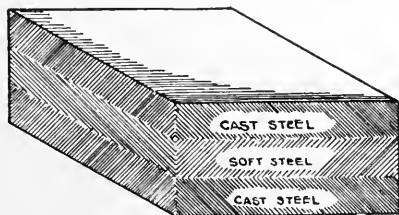

FIG. 27—DRAWING ILLUSTRATING THE CONSTRUCTION OF SOFT-CENTER STEEL

74. **Soft-center steel**, used in tillage machinery, is made up of a layer of soft steel with a layer of high-carbon steel on each side. The high-carbon steel may be made glass hard, yet the soft center will support the surface and prevent breakage. In making soft-center steel, a slab of high-carbon steel is welded to each side of a soft steel

slab and the whole rolled into plates (Fig. 27). A soft-center steel may be made by carbonizing a plate of mild steel by a process much the reverse of malleable making.

### STRENGTH OF MATERIALS

All materials used in construction resist a stress or a force tending to change their form. Stresses act in three ways: (1) tension, tending to stretch; (2) compression, tending to shorten; and (3) shear, tending to slide one portion over another.

**75. Tension.**—Material subjected to a stress tending to stretch it, as a rope supporting a weight, is said to be under tension, and the stress to the square inch of the cross section required to break it is its tensile strength.

**76. Compression.**—Material is under compression where the stress tends to crush it. The stress to the square inch required to crush a material is its compressive strength.

**77. Shear.**—The shearing strength of a material is the resistance to the square inch of cross section required to slide one portion of the material over the other.

**78. Transverse strength of materials.**—When a beam is supported rigidly at one end and loaded at the other, as in Fig. 28, the material of the under side of the beam is under a compressive stress, and that of the upper part is subjected to a tensile stress. The property of materials to resist such stresses is termed their transverse strength.

**79. Maximum bending moment (B.M.)** is a measure of the stress tending to produce rupture in a beam, and for a cantilever beam (i. e., one supported rigidly at one end, Fig. 28) is equal to the load times the length of the beam ( $W \times L$ ). The maximum bending moment depends upon the way a beam is loaded and supported; thus with a simple beam loaded at the center and sup-

ported at both ends the bending moment is one-half the weight times the length.

The maximum bending moment for the cantilever beam of Fig. 28 is at the point where it is supported. If the beam be of a uniform cross section, it will rupture at this point before it will at any other. The bending

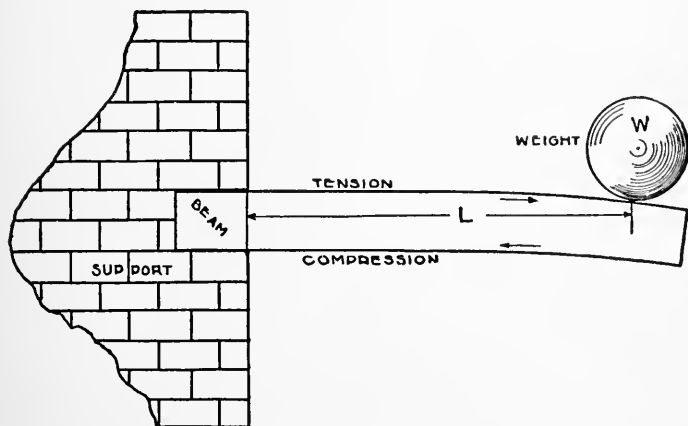

FIG. 28—A CANTILEVER BEAM

moment in the beam at hand grows less as the distance from the weight becomes less. As the bending moment becomes less, less material is needed to resist it, and hence a beam may be designed of such a section as to be of equal strength at all points, or it is what is called a beam of uniform strength.

Much material may be saved by placing it where most needed. The location as well as the value of the maximum bending moment depends upon the way the beam is loaded.

**80. Modulus of rupture (M.R.).**—It is seldom that a material has a tensile strength equal to its strength to

resist compression, so neither of these may be used for transverse stresses. The modulus of rupture is a measure of the transverse stresses necessary to produce rupture

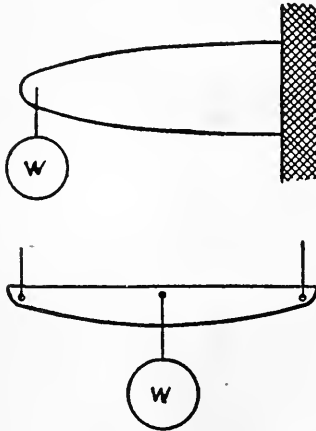

FIG. 29—BEAMS OF UNIFORM STRENGTH

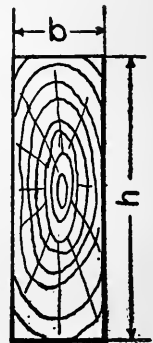

FIG. 30

and is determined experimentally. It is usually a quantity lying between the compressive and tensile strengths of the material.

81. **Section modulus (S.M.)** is the quantity representing the ability of the beam to resist transverse stresses. It has been noticed by all that a plank will support a greater load on the edge than on the flat. For a rectangular cross section, Fig. 30, if  $h =$  depth in inches and  $b =$  breadth in inches, the section modulus is

$$\frac{b h^2}{6};$$

that is, the strength of a rectangular beam is proportional to its breadth and to the square of its depth.

*When a beam is loaded to its limit, bending moment = section modulus × modulus of rupture.*

This is a general equation which applies to all beams.

**82. Factor of safety.**—In the design of machinery it is customary to make the parts several times as strong as would be needed to carry normal loads. The number of times a piece is made stronger than necessary simply to carry the load is called the factor of safety, and in farm machine design it varies from 3 to 12.

For a more complete discussion of this subject see any work on mechanics of materials.

AVERAGE STRENGTH OF MATERIAL PER SQUARE INCH

Material	Tensile Strength	Compressive Strength	Modulus of Rupture
Hickory.....		9,000	15,000
Oak .....		8,500	13,000
White pine.....		5,400	7,900
Yellow pine.....		8,000	10,000
Cast iron.....	18,000	80,000	45,000
Steel.....	60,000	52,000	55,000
Wrought iron.....	50,000	48,000	48,000

Values for the strength of timber were obtained from U. S. Forestry Circular No. 15. If the load or stress be continued for a long time the ultimate strength of timber will be only about one-half the above and for this reason much lower values are often given in architects' hand-books.

For a more complete table see any engineers' hand-book.\*

\*"Architects' and Builders' Pocket-Book." By F. E. Kidder.  
 "Materials of Construction." By J. B. Johnson.

Problem: Find the safe load on an oak doubletree 4 feet long, 4 inches wide, 2 inches thick. Factor of safety = 6.

Let  $L$  = length in inches,  $W$  = load in pounds,  $b$  = thickness,  $d$  = width in inches.

$$\text{Bending moment} = \frac{1}{2}WL = \frac{1}{2}W48 = 24W.$$

$$\text{Section modulus} = \frac{bd^2}{6} = \frac{2 \times (4)^2}{6} = 5.333.$$

Modulus of rupture for oak = 13,000.

$$\text{Bending moment} = \frac{\text{Sect. Mod.} \times \text{Mod. of Rupt.}}{\text{Factor of Safety}}$$

$$24W = \frac{5.333 \times 13,000}{6}$$

$$W = 481.5 \text{ pounds. (Ans.)}$$



## CHAPTER IV

### TILLAGE MACHINERY

**83. Object of tillage.**—Agricultural implements and machines used in preparing the soil for the seeding or growth of crops may be classed as tillage machinery. Tillage is the art which includes all of the operations and practices involved in fitting the soil for any crop, and the caring for it during its growth to maturity.

Tillage is practiced to secure the largest returns from the soil in the way of crops. Its objects have been enumerated in other works about as follows:

(1) To produce in a field a uniform texture to such a depth as will render the most plant food available.

(2) To add to the humus of the soil by covering beneath the surface to such a depth as not to hinder further cultivation, green crops and other vegetable matter.

(3) To destroy and prevent the growth of weeds, which would tend to rob the crops of food and moisture.

(4) To modify the condition of the soil in such a way as to regulate the amount of moisture retained and the temperature of the soil.

(5) To provide such a condition of the soil as to prevent excessive action of the rains by washing and the wind by drifting.

At the present time practically all of the various operations of tillage are carried on by aid of machinery, and for this reason tillage machinery is of greatest importance in modern farming operations. Modern tillage machinery has enabled the various objects as set forth to

be realized, thus not only increasing the yield an acre, but at the same time permitting a larger area to be tilled.

### THE PLOW

**84. The development of the plow.**—The basic tillage operation is that of plowing, and for this reason the plow will be considered first. Some of the oldest races have left sculptural records on their monuments describing their plows. From the time of these early records civilization and the plow have developed in an equal proportion. The first plow was simply a form of hoe made from a crooked stick of the proper shape to penetrate and loosen the soil as it was drawn along. The power to draw the plow was furnished by man, but later, as animals were trained for draft and burden, animal power was substituted and the plow was enlarged.

The records of the ancient Egyptians illustrate such a plow. At an early time the point of the plow was shod with iron, for it is recorded that about 1,100 years B.C. the Israelites, who were not skilled in the working of iron, "went down to the Philistines to sharpen every man his share and his coulter." In the "Georgics," Virgil describes a Roman plow as being made of two pieces of wood meeting at an acute angle and plated with iron.

During the middle ages there was but little improvement over the crude Roman plow as described by Virgil. The first people to improve the Roman model were the Dutch, who found that a more perfect plow was needed to do satisfactory work in their soil. The early Dutch plow seems to have most of the fundamental ideas of the modern plow in that it was made with a curved moldboard, and was provided with a beam and two handles. The Dutch plow was imported into Yorkshire, England, as early as 1730, and served as a model for the early English plows. P. P. Howard was one whose name may be mentioned among those instrumental in the development of the early English plow. Howard established a factory, which remains to this day.

James Small, of Scotland, was another who did much toward the improvement of the plow. Small's plow was designed to turn the furrows smoothly and to operate with little draft.

Robert Ransome, of Ipswich, England, in 1785 constructed a plow with the share of cast iron. In 1803 Ransome succeeded in chilling his plows, making them very hard and durable. The plows of Howard and Ransome were provided with a bridle or clevis for regulating the width and depth of the furrow. These plows were exhibited and won prizes at the London and the Paris expositions of 1851 and 1855.

**85. American development.**—Before the Revolutionary War the plows used in America were much like the English and Scotch plows of that period. Conditions were not favorable to the development of new machinery or tools. The plow used during the later colonial period was made by the village carpenter and ironed by the village smith with strips of iron. The beam, standard, handles, and moldboard were made of wood, and only the cutting edge and strips for the moldboard were made of iron.

Among those in America who first gave thought to the improvement of the plow was Thomas Jefferson. While representing the United States in France he wrote: "Oxen plow here with collars and harness. The awkward figure of the moldboard leads one to consider what should be its form." Later he specified the shape of the plow by stating: "The offices of the moldboard are to receive the sod after the share has cut it, to raise it gradually, and to reverse it. The fore end of it should be as wide as the furrow, and of a length suited to the construction of the plow."

Daniel Webster is another prominent American who, history relates, was interested in the development of the plow. He designed a very large and cumbersome plow for use upon his

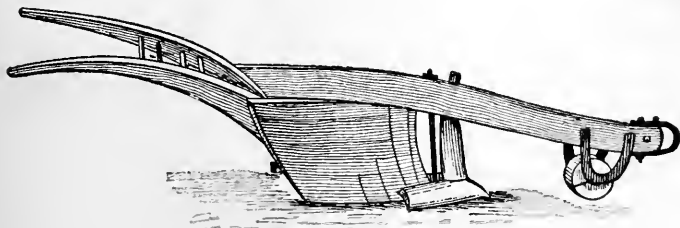

FIG. 31—WEBSTER'S PLOW

farm at Marshfield, Massachusetts. It was over 12 feet long, turned a furrow 18 inches wide and 12 inches or more deep, and required several men and yoke of oxen to operate it.

Charles Newbold, of Burlington, New Jersey, secured the first letters patent on a plow in 1797. Newbold's plow differed from others in that it was made almost entirely of iron. It is stated

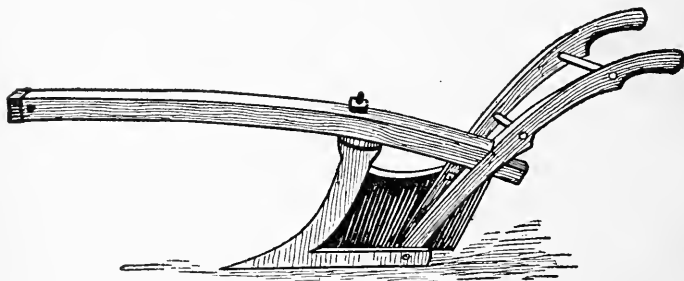

FIG. 32—THE NEWBOLD PLOW

that the farmers of the time rejected the plow upon the theory that so much iron drawn through the soil poisoned it, and not only retarded the growth of plants, but stimulated the growth of weeds.

Jethro Wood gave the American plow its proper shape. The moldboard was given such a curvature as to turn the furrow evenly and to distribute the wear well. Although Wood's plow was a model for others which followed, he was unrewarded for his work, and finally died in want. William H. Seward, former Secretary of State, said of him: "No man has benefited his country pecuniarily more than Jethro Wood, and no man has been as inadequately rewarded."

**86. The steel plow.**—As farming moved farther west the early settlers found a new problem in the tough sods of the prairie States. A special plow with a very long, sloping moldboard was found to be necessary in order to reduce friction and to turn the sod over smoothly. Owing to the firmness of the sod, it was found that curved rods might be substituted for the moldboard. Later when the sod became reduced it was found that the wooden and cast-iron plows used in the eastern portion of the country would not scour well. This difficulty led to the

use of steel in the making of plows. Steel, having the property of taking an excellent polish, permitted the sticky soils to pass over a moldboard made of it where the other materials failed.

In about 1833 John Lane made a plow from steel cut from an old saw. Three strips of steel were used for the moldboard and one for the share, all of which were fastened to a "shin" or frame of iron. John Lane secured in 1863 a patent on soft-center steel, which is used almost universally at the present time in the making of tillage tools. It was found that plates made of steel were brittle and warped badly during tempering. Welding a plate of soft iron to a plate of steel was tried, and, although the iron supported the steel well when hardened, it warped very badly. The soft-center steel, which was formed by welding a heavy bar of iron between two bars of steel and rolling all down into plates, permitted the steel to be hardened without warping. It is very strong on account of the iron center, which will not become brittle.

In 1837 John Deere, at Grand Detour, Illinois, built a steel plow from an old saw which was much similar to Lane's first plow. In 1847 Deere moved to Moline, Illinois, and established a factory which still bears his name. William Parlin established a factory about the same time at Canton, which is also one of the largest in the country.

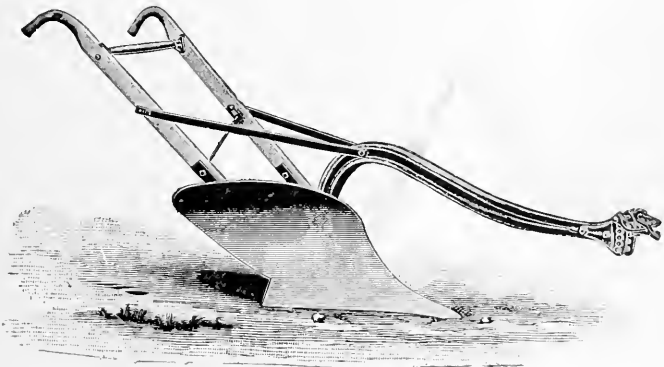

FIG. 33—THE MODERN STEEL WALKING PLOW WITH STEEL BEAM FOR STUBBLE OR OLD GROUND

87. **The sulky or wheel plow.**—The development of the sulky or wheel plow has taken place only recently. F. S. Davenport invented the first successful sulky plow, i. e., one permitting the operator to ride. February 9, 1864. A rolling coulter and a three-horse evener were added to this by Robert Newton, of Jerseyville, Illinois. But E. Goldswait had patented a fore carriage in 1851 and M. Furley a sulky plow with one base December 9, 1856. Much credit for the early development of the sulky plow is due to Gilpin Moore, receiving a patent January 19, 1875. and W. L. Cassady, to whom a patent was granted May 2, 1876. Cassady first used a wheel for a landside. Too much space would be required to mention the many inventions and improvements which have been added to the sulky plow.



FIG. 34—AN UNDER VIEW OF THE MODERN STEEL PLOW, SHOWING ITS CONSTRUCTION

88. **The modern steel walking plow.**—Fig. 34 shows the modern steel walking plow suitable for the prairie soils. The parts are numbered in the illustration as follows:

1. Cutting edge or share. The **point** is the part of the share which penetrates the ground, and the **heel** or **wing** is the outside corner. A share welded to the landside is a **bar** share, while one that is independent is a **slip** share.

2. Moldboard: The part by which the furrow is turned. The **shin** is the lower forward corner.

3. Landside: The part receiving the side pressure produced when the furrow is turned. A plate of steel covers

the landside bar, furnishing the wearing surface. When used for old ground, the plow is usually constructed with the bar welded to the frog, forming the foundation to which the other parts are attached. Landsides may be classed as high, medium, and low.

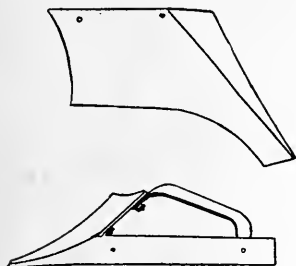

FIG. 35—STEEL PLOWSHARES. THE UPPER IS THE SLIP SHARE, AND THE LOWER THE BAR SHARE

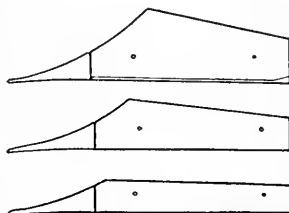

FIG. 36—THE FORM OF THE HIGH, MEDIUM, AND LOW LANDSIDES FOR WALKING PLOWS

4. Frog: The foundation to which are attached the share, moldboard, and landside.

5. Brace.

6. Beam: May be of wood or steel. The beam in a wooden-beam plow is joined to the plow by a beam standard.

7. Clevis, or hitch for the adjustment of the plow.

8. Handles: The handles are joined to the beam by braces.

9. Coulter: Classified as rolling, fin, or knife coulters.

**89. Material.**—While in the cheaper plows the moldboard and share may be of Bessemer or a grade of cast steel, in the best plows these and also the landside are usually made of soft-center steel or chilled iron. The beam is usually of Bessemer steel, while the frog may be of forged steel, malleable iron, or cast iron.

90. **Reënforcements.**—A patch of steel is usually welded upon the shin, the point of the share, and the heel of the landside. These parts are also made interchangeable so new parts may be substituted when worn.

91. **Size.**—Walking plows are made to cut furrows

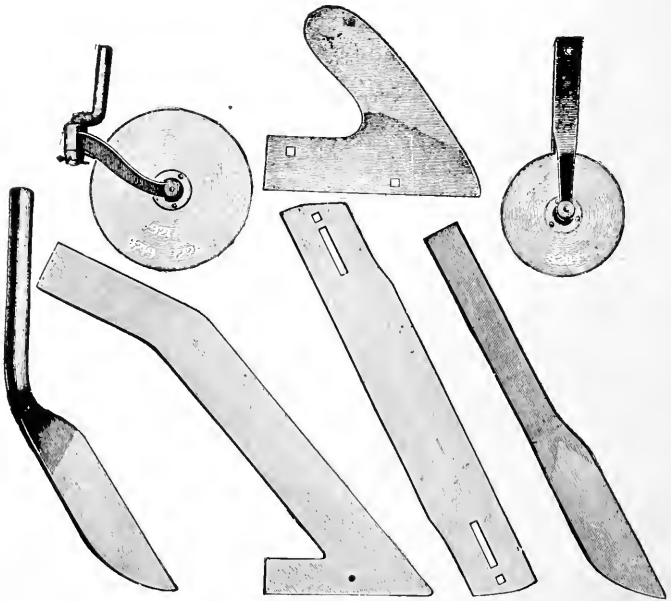

FIG. 37—ROLLING CASTER AND ROLLING STATIONARY COULTERS, FIN HANGING, KNEE, DOUBLE ENDER, AND KNIFE CUTTERS OR COULTERS

from 8 to 18 inches. A plow cutting a 14-inch furrow is considered a two-horse, and one cutting a 16- or an 18-inch furrow a three-horse plow.

92. **The modern sulky plow.**—The name sulky plow is used for all wheel plows, but applies more particularly to single plows, while the name **gang** is given to double or



larger plows. Fig. 38 illustrates the typical sulky plow, and reference is made to its various parts by number:

1. The moldboard, share, frog or frame, and landside is called the plow **bottom**. Most sulky plows are made with interchangeable bottoms, so it is possible to use the same carriage for various classes of work by using suitable bottoms.

2 and 3 are the **rear** and the **front furrow wheels**, respectively. These wheels are set at an angle with the

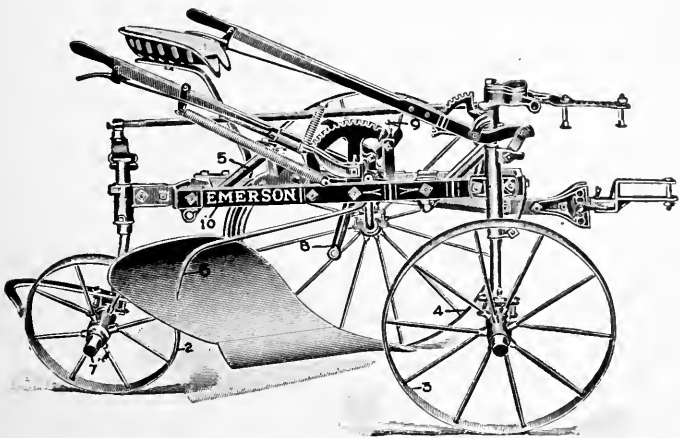

FIG. 38—THE MODERN FOOT-LIFT BEAM-HITCH SULKY PLOW WITH STEEL PLOW BOTTOM

vertical in order that they may carry to better advantage the side pressure of the plow due to turning the furrow slice.

4. The largest wheel traveling upon the unplowed land is spoken of as the **land wheel**.

5. The connections between the plow beam and the frame are called the **bails**.

6. A rod called the **weed hook** is provided to collect the tops of high vegetation.

7. Practically all wheel plows are now provided with **inclosed wheel boxes**, which exclude all dirt and carry a large supply of grease. The inclosed wheel box has a collar which excludes the dirt at the axle end of the wheel box, and has the other end entirely inclosed with a cap. The grease is usually stored in the cap, which is made detachable from the hub.

8. Wheel plows are now generally provided with a **foot lift**, by which the plow is lifted out and forced into the ground.

9. For plowing in stony ground, it is necessary to set the plow to float, so that in case a stone is struck the plow will be free to be thrown out of the ground without lifting the carriage, otherwise the plowman will be thrown from his seat and the plow damaged.

10. The various parts of the sulky plow are usually attached to the **frame**, and this is an important part in the construction of the plow. Not all sulky plows, however, are made with a frame.

93. **Types of sulky plows.**—Sulky plows differ much in construction. The two-wheel plow is not used extensively at the present time because it does not carry the side pressure of the plow well and does not turn a good square corner. One type of construction is that of a **frame** with wheels attached by means of brackets, making a carriage. To this carriage the plow proper is attached by bails. The **hitch** to frame plows may be to either the frame or to the plow beam. The former is known as a **frame hitch** and the latter as a **beam hitch**. There are good plows upon the market with a frame hitch, but the beam hitch plow seems to be preferred.

A cheaper type of plow than the frame plow is the

**frameless**, with the wheel brackets bolted directly to the plow beam. Such plows will often do very satisfactory work, but are not quite so handy. Frame plows are generally **high-lift** plows in that the plow may be lifted several inches above the plane of the carriage. A high-lift plow offers an advantage for cleaning and transporting from field to field.

With the cheaper plows there is no attempt to guide or steer the plow other than let it follow the team. Such plows may be classed as **tongueless**. A tongueless plow may, however, be provided with a hand lever either to shift the hitch or guide the front furrow wheel. Such a plow may be called a hand-guided plow, and the lever for guiding or adjusting is called the **landing** lever.

There is still another type of frameless plow which is guided by the hitch. In the **hitch-guided** plow the front

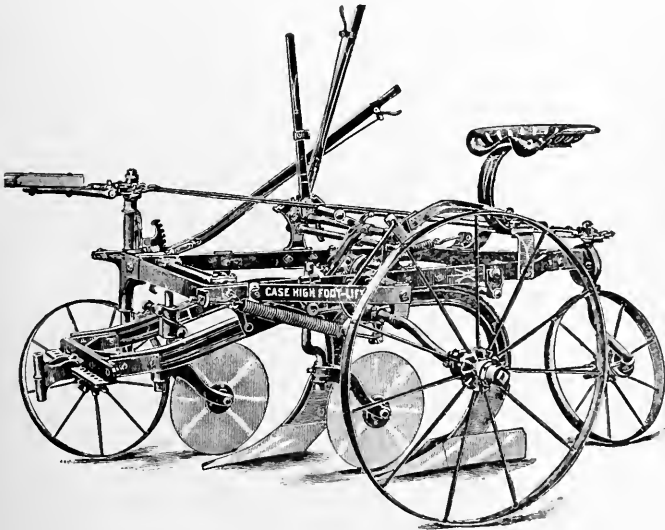

FIG. 39—THE MODERN GANG PLOW

furrow wheel or the front and rear furrow wheels are steered by a connection to the plow clevis. A tongue may be used with this type of plow to keep the team straight and to hold the plow back from off the horses' heels while being transported.

The higher class sulky plows are guided with an adjustable tongue, the tongue being connected to the front and rear furrow wheels.

Sulky plows are usually fitted with a 14-, 16-, or 18-inch plow bottom, the 16-inch being the common size.

94. **Gang plows.**—Nearly every sulky plow upon the market has its mate among the gang plows, which, as stated before, do not differ greatly from it, only in that they have two or more plow bottoms instead of one. Gang plows usually have a hand lever to assist the foot lift in raising and lowering the plow. The common sizes of gang-plow bottoms are 12- and 14-inch.

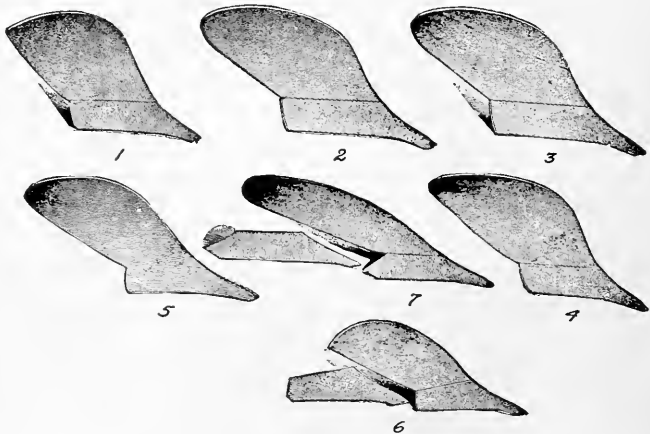

FIG. 40—TYPES OF PLOW BOTTOMS. NO. 1 IS THE STUBBLE OR OLD GROUND BOTTOM. NO. 7 IS THE BREAKER BOTTOM FOR TOUGH NATIVE SODS. NOS. 2, 3, 4, 5, AND 6 ARE INTERMEDIATE TYPES FOR GENERAL PURPOSE PLOWS

95. **Types of plows' bottoms.**—The plow bottom, as stated before, is the plow proper, detached from the beam or standard. Owing to the varying conditions under which ground is to be plowed, a few general types, each with its own form of moldboard and share, have been established. These forms are illustrated in Fig. 40, and vary from No. 7, the **breaker**, with its long sloping share and moldboard, for natural sods, to No. 1, the stubble plow with short, abrupt moldboard for old ground. The

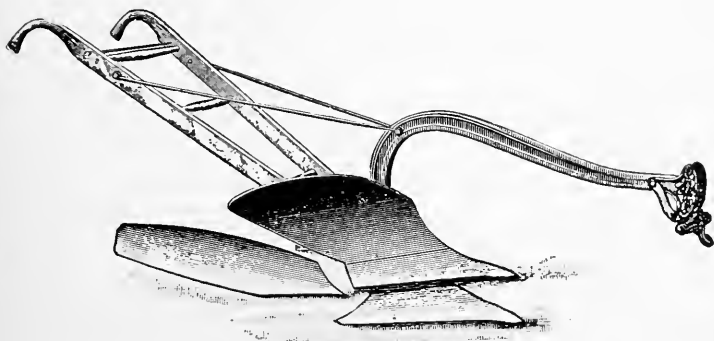

FIG. 41—A STEEL WALKING PLOW WITH INTERCHANGEABLE MOLDBOARDS, BY WHICH IT MAY BE MADE INTO A BREAKER OR STUBBLE PLOW

intermediate forms are given the name of turf and stubble, or **general purpose**, plows, being used for the sod of the cultivated grasses or for stubble ground. The breaker is suitable for the native sods of the Western prairies, as it turns the furrows very smoothly and covers the vegetation completely, that it may decay quickly. The abrupt curvature of the moldboard in the stubble bottom causes the furrow slice to be broken and crumbled in making the sharp turn, and thus has a more pulverizing action and is designed for old ground. The general purpose plow is designed for the lighter sods, such as those of the tame grasses.

Some manufacturers make plows with interchangeable moldboards, and sulky plows are usually built with interchangeable bottoms, so the plow or carriage may be used for a variety of soils.

**96. The jointer.**—The jointer is used in soils inclined to be soddy. It enables the plow to do cleaner work and cover all vegetation, throwing a ribbon-like strip of turf into the furrow. It will often render excellent service

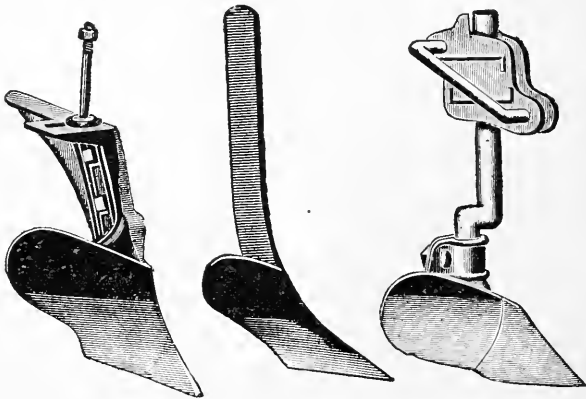

FIG. 42—TYPES OF JOINTERS. THE TWO AT THE LEFT ARE MADE OF STEEL; THE ONE AT THE RIGHT IS A CHILLED IRON JOINTER WITH AN ADJUSTABLE SHANK

where sod ground is to be plowed deep and left in shape for immediate pulverizing to fit it for crops. It will cut out a section of the sod, turning it into the bottom of the furrow, where it will be completely covered, and at the same time leave the upper edge of the furrow slice composed only of comparatively loose earth. By cutting out the corner of the furrow slice, the furrows will be completely inverted, leaving the surface smooth. If the furrow slice is perfectly rectangular, the furrows are inclined to pile or lap over each other.

97. **The chilled plow.**—In many places, especially in the eastern United States, many of the plows used are of chilled cast iron. A chilled plow with a reversible point

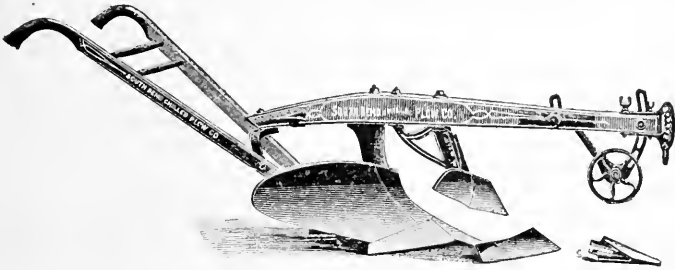

FIG. 43—A MODERN CHILLED WALKING PLOW WITH JOINTER AND GAUGE WHEEL

is shown in Fig. 43. Chilled plows are very hard, but will not scour in all soils. The share can only be ground to an edge when dull, or it may be replaced at a small cost.

98. **The hillside plow.**—In localities too sloping to throw the furrow uphill, hillside or reversible plows are



FIG. 44—A REVERSIBLE OR HILLSIDE PLOW WITH KNIFE COULTER

used. A plow which may be made a right- or left-hand plow by turning it under on a hinge to the standard is shown in Fig. 44. In irrigated districts where dead fur-

rows interfere with the carrying of water upon the land, reversible plows are used. These are of many forms, but the type will not be further discussed.

**99. The subsoil plow.**—Where it is desirable to loosen the ground to a greater depth than can be done with a surface plow, the subsoil plow is used. It is used with

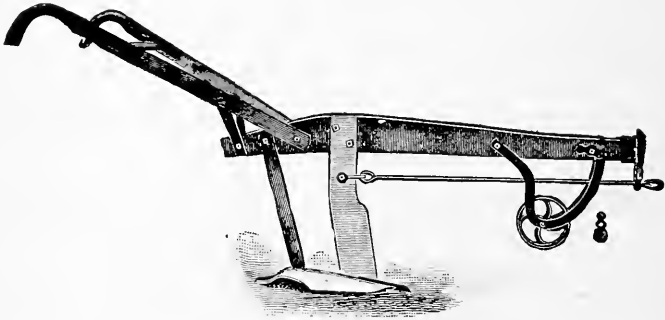

FIG. 45—A SUBSOIL PLOW FOR LOOSENING THE SOIL IN THE BOTTOM OF THE FURROW MADE BY THE COMMON PLOW

the regular plow, following in the furrow made by it. Opinions in regard to the value of this plow differ, but the subject will not be discussed here.

**100. The disk plow.**—The disk plow is the result of an effort on the part of inventors to reduce the draft due to the sliding friction upon the moldboard. Figs. 46 and 47 show the modern disk plow made for horse and engine power, respectively. A plow consisting of three disks cutting very narrow strips was about the first one patented, M. A. and I. N. Cravath, of Bloomington, Illinois, being its inventors. Under certain conditions, it is said, this plow did very satisfactory work, but the side pressure was not sufficiently provided for. M. F. Hancock succeeded in introducing the disk plow into localities



where conditions were well adapted to its use, and became prominent as a promoter of the disk plow.

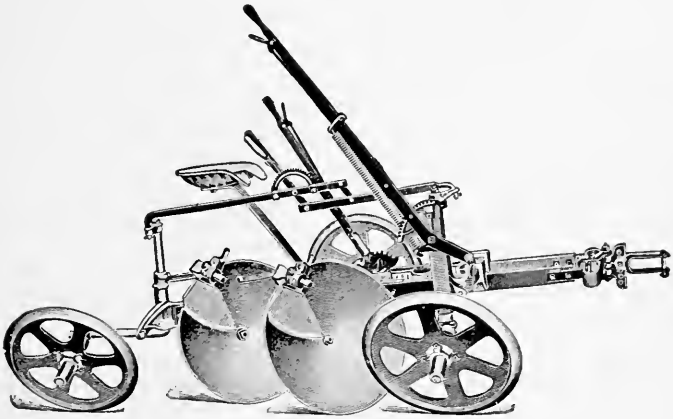

FIG. 46—A DISK GANG PLOW TO BE OPERATED BY HORSE POWER

The draft of the disk plow is often heavier in proportion to the amount of work done, and the plow itself is

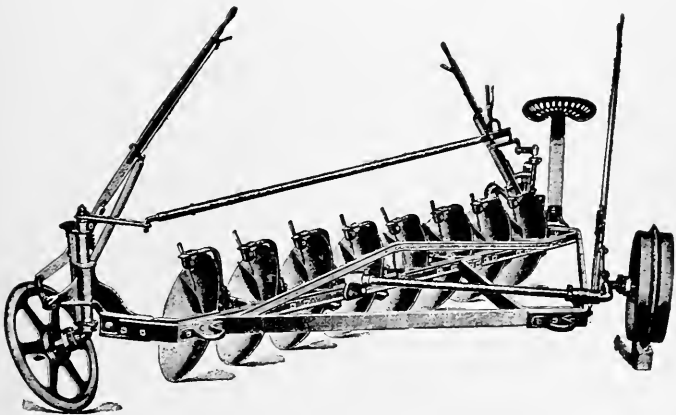

FIG. 47—AN ENGINE DISK GANG PLOW TURNING 8-, 10-, OR 12-INCH FURROWS

more clumsy than the moldboard plow; so where the latter will do good work there is no advantage in using the former. In sticky soils, however, or in very hard ground, where it is impossible to use the moldboard plow, the disk will often be found to do good work, and in the latter case with much less draft. The moldboard plow is recommended by the manufacturers of both plows where it will do good work.

Disk plows have been made in the walking style within the past few years, but have proved rather unsatisfactory. A few of this style are suitable for hillside and irrigation plows, being made reversible.

**101. The steam plow.**—Where steam power is used for other purposes, or where farming is carried on extensively, steam may be used at a saving over horse power in plowing. This has been attempted for many years, but it has only recently become very successful, and even now the steam plow is used only on large farms and on level land. If the soil is not firm, the great weight causes the traction wheels of the engine to sink into the ground until the plow cannot be pulled.

The modern steam plow, direct connected, steered from the rear, and having a steam lift, is a very successful machine. Its advantages are its capacity and unlimited power for deep plowing. The cost of plowing with a steam plow varies with the cost of fuel and other conditions, but it should be from 75 cents to \$1.50 an acre. Outfits capable of plowing and at the same time preparing the seed bed and seeding 40 to 50 acres in a day are now in use.

A type of steam plow which has been successful in Europe is operated by a system of cables. The plow is drawn back and forth across the field by means of the cable, the engine being placed at one end of the field.

The steam plow may, in some cases, in certain soils, be the means of producing an increase of yield of crops, by plowing to a greater depth than could be done by horse power.

**102. The set of walking plows.**—The original set of a plow, or the proper adjustment of its point, share, and beam, is given by the maker. Each time when the plow is sharpened the smith is depended upon to return this set to the plow.

**103. Suction.**—The suction of a plow is usually measured as the width of the opening between the landside and a straight edge laid upon it when the plow is bottom side up. It is usually about  $\frac{1}{8}$  inch, but may vary slightly

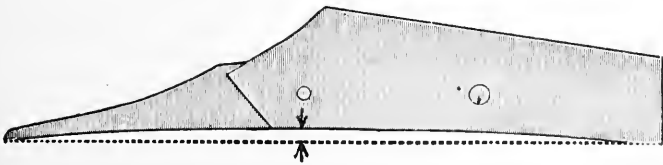

FIG. 48—THE SUCTION OF WALKING PLOWS SOMEWHAT EXAGGERATED

without detriment to the plow. It may also be described as the amount the point is turned down to secure penetration.

The point of the share is also turned slightly outward, which makes the line of the landside somewhat concave. The beam of a three-horse plow is in a line with the landside, but in a two-horse plow it is placed a little to the furrow side of the line of the landside, usually about 3 inches, in order that the hitch may be more directly behind the team. For ordinary plows the point of the beam stands 14 inches high, but it is higher for hard soils. Some **bearing** must be given at the heel of the share in walking plows, to carry the downward pressure of the

furrow. One inch width of bearing surface for 12- and 14-inch plows and  $1\frac{1}{4}$  inches for 16-inch plows is the average width of this bearing, more being needed for soft, mellow soils than for firm soils. This fact necessitates a change in the plow in changing from hard to mellow soils, as a share set for a hard soil will swing to one side or work poorly in the mellow soil. A handy device called a **heel plate** is sometimes used to vary the width of surface at the heel.

**104. The set of sulky plows.**—With the sulky plow, when the share lies on a flat surface, the distance from the heel of the landside to the surface is called the suction.

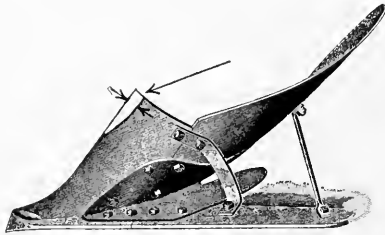

FIG. 49—THE BEARING SURFACE REQUIRED AT THE WING OF THE SHARE

In sulky and gang plows this is usually  $\frac{1}{2}$  inch. The entire downward pressure or suction should be carried upon the wheels or carriage, which, with their well lubricated bearings, will reduce the draft and require no bearing surface at the wing of the share. In order to reduce the friction by removing the pressure from the landside, the rear furrow wheel is set outside the line of the landside, usually about  $1\frac{1}{4}$  inches.

**105. Set of coulter.**—The rolling coulter should be set to clear the shin of the plow by about  $\frac{1}{4}$  inch, and should cut  $\frac{1}{2}$  inch or  $\frac{3}{4}$  inch outside the shin. It is said that if

the coulter is made to cut 1 inch or more outside the landside, thus increasing the load upon the plow, it can be made to scour when giving difficulty in this respect. When plowing among roots the plow is enabled to run over rather than underneath large roots by inclining the knife coulter backward with its point below the point of the plow; otherwise the knife coulter must be set with the lower point well ahead.

**106. Scouring.**—Some soils are of such a nature that a plow can be made to scour only with difficulty. This is true especially of soils in the Middle West. In other localities plows give little trouble in this respect. When the plow is at fault, poor scouring may be due (1) to poor temper. In this case the share and moldboard are not hard enough to take a good polish, and hence will not scour well. These parts should be so hard that they can barely be scratched with a file. (2) To poor grinding. Sometimes hollows have been ground into the moldboard, over which the furrow slice presses so lightly that not enough pressure is given to cause the spot to scour. This may readily be tested by carrying the tips of the fingers up the plow quickly, from the edge of the share in the direction the soil moves. (3) To a poor fitting, i. e., where the joint between the share and moldboard is not smooth. A remedy for this is procured by shimmering the share up or down with small pieces of pasteboard. (4) To the edge of the share not being level, making a low spot back of the edge. This is usually caused by a warped share. (5) To poor setting. The plow must be set as previously described.

**107. Sharpening steel shares.**—It is recommended by some manufacturers that until necessary only the extreme point of a share be heated to put into form, the edge being sharpened by grinding; but when necessary

to heat and draw to an edge by hammering, they recommend the following procedure :

The point should be heated to a low cherry red. If the heat is too intense, the quality of the steel will be injured. Only as much should be heated at once as can be hammered. The body of the share must be kept cool and strong so the fitting edges may not be disturbed. After this, the entire cutting edge should be cold hammered. The share should then be set on a level platform, leaving  $1/16$  inch under the middle piece to give proper suction or pitch. The edge must touch all the way along, and the proper bearing must be given at the wing.

**108. Hardening plowshares.**—A hardened share will retain its cutting edge much longer than a soft share. It is highly advisable, after each time the edge is drawn out by heating and hammering, that the share be hardened. Some soils require hardened steel shares in order that they may retain their scouring qualities. Several reliable manufacturers give directions for sharpening and hardening shares made of soft-center steel about as follows: **Sharpening:** The whole point should be heated to a very low red heat, then the face of the share must be turned downward with the heel over the fire and the point about 2 inches higher than the heel. In this way the whole length of the share will be heated almost in one heat, as the fire will be drawn along from the heel toward the point. An uneven heat will warp and crack the share. When a moderate heat has been reached it must be removed, and it will be noticed if the share is sprung up along the edge. This must be set right, and the following methods may be used to harden :

First. The edge must be made hard and springy by cold hammering; then the share is to be heated as described to a low cherry red. It should be let into the

water (holding it bottom side up) far enough to cool the edge, then taking it out, and the color should be watched as the heat returns to the edge. When a dark straw or mottled purple reaches the edge, the entire share may be cooled.

Second. If a supply of oil is at hand, the share may be tempered with less risk of breakage. When oil is used (linseed or lard oil will answer) the share is to be heated as before to a low cherry heat, then lowered into the oil till entirely cool. After this it must be held over the fire till the temper is sufficiently drawn, which will be indicated by the oil on the thin part of the share taking fire. It may finally be cooled by immersion in cold water.

**109. Draft of plows.**—The nature of soils, growth of roots, and amount of moisture present influence the draft of plows. The shape of the moldboard also affects the draft, the more abrupt curvature producing a more pulverizing action upon the furrow slice, and requiring more work.

Professor J. W. Sanborn, of Missouri, made tests to determine the reduction of draft due to the use of a coulter, the results of which are as here given. The tests were made with a plow similar to the sod or breaking plow, and in clover sod two years old, with about as much moisture present as would permit working the soil advantageously. The results were as follows:

	Size of Furrow	Total Draft	Draft per Sq. In.
Sod plow with wheel coulter...	5.575" × 15.08"	296.25	3.524
" " without " ...	5.325" × 14.5"	343.75	4.453
Difference.....		47.50	.929

The coulter resulted in better work and diminished the draft 20.86 per cent. A later series of observations

was made on clover sod, the plow being provided with a wheel coulter, the soil being drier than before. The following results were obtained:

	Size of Furrow	Total Draft	Draft per Sq. In.
Clover sod without coulter....	6.47" × 11.61"	714.35	10.80
" " with " ....	6.413" × 12.47"	664.82	8.616
Difference.....		49.53	2.184

In these tests the coulter reduced the draft 25.34 per cent.

It is stated in the report of the trials of plows at Utica that the total draft of a plow is divided as follows: 35 per cent is used in overcoming the friction between the implement and the soil, 55 per cent in cutting the furrow slice, and 10 per cent in turning it. The accuracy of these tests has been doubted by some, but the tests seem to have been conducted with care, and they show the necessity of keeping a sharp cutting edge. It is desirable that data of this kind be obtained by tests made with modern plows.

**110. Draft of sulky plows.**—It is often claimed that the draft of sulky plows is less than that of walking plows, owing to the friction of the sole and landside being transferred to the well-oiled bearings of the carriage. But records show that there is no gain unless the weight of the driver and the frame is deducted. But there is an evident advantage in riding plows, even if the draft is slightly greater on the team with the plowman riding rather than walking, and the plow being handled with equal facility. Though little information is at hand on the subject, what there is seems to indicate that there is only a slight difference in the draft of walking and riding plows, in proportion to the amount of work done.

**111. The selection of a walking plow.**—The best in



quality of material and workmanship is desirable when selecting a walking plow. It may be difficult to judge of the material, but the workmanship can be easily determined. Beginning with the frog, the plow should be well made and put together, and at this point a vast difference in plows may be detected. The work to be done should determine the kind of plow to be selected, and the type of mold-board must be suited to the soil to be turned. While steel-beamed plows are used to better advantage in plowing among trash, plows with wooden beams have an advantage in being lighter and less likely to be sprung. A wooden-beam plow, striking a rock or root, may have the beam broken, while with a steel-beam plow it may be distorted. A right-hand plow is one that turns the furrow to the right, and a left-hand plow is one turning the furrow to the left. The custom established in the locality where it is to be used should determine the one to select, as one has no advantage over the other.

**112. The selection of a sulky plow.**—As is the case with the walking plow, the quality of a sulky plow will be indicated largely by its construction and workmanship, although its selection requires more care than that of a walking plow. To be brief, a well-made plow and one easily operated as regards foot lifts and levers should be chosen. It should turn a square corner in either direction, and all parts subject to wear should either be adjustable or made of generous dimensions. This applies especially to bail boxes on bail plows.

**113. Adjusting the walking plow.**—A few points regarding the operation of plows should be mentioned. A walking plow, if working properly, should need very little attention from the plowman, only requiring him to steady it with the handles. If it requires a steady pull to either

side, either the hitch or the clevis should be adjusted or the amount of bearing given at the heel or wing is too great or too small. It should be seen that the point is well turned down and never allowed to become rounding. If it becomes much worn, new metal must be added. It is desirable to maintain the original amount of suction and the distance from point of share to point of beam; in fact, the entire form of the plow should be maintained as nearly as possible in its original condition, providing it worked satisfactorily when new.

As given in former data, a large proportion of the draft is due to the cutting of the furrow. This shows the importance of keeping the cutting edge sharp. It has also been stated that if after being sharpened the share is hardened, the cutting edge will be retained longer.

**114. Adjusting the sulky plow.**—The land wheel of a three-wheel sulky or gang plow should travel directly to the front, but often, owing to bad adjustment, it is required to slip occasionally, because it is traveling at an angle with the direction of the plow's motion. The rear furrow wheel is usually given a small "lead" from the land, i. e., it is turned out a little from the unplowed land. This wheel should also be set an inch or so outside of the line of the landside, in order to remove the friction from this part as much as possible. The front furrow wheel is given "lead" from the land with the single plow, and toward the land when the team is hitched abreast on gangs. This difference in the latter case is because the line of draft is outside the line of work, and the plow is made to travel directly to the front by the front furrow wheel being turned in.

In any wheel plow the load should be carried as much as possible on the wheels in order to reduce the draft. There should be a reduction in draft when the entire load,

due to lifting and turning the furrow slice, is carried upon the carriage wheels with the well-lubricated bearings, rather than upon the sole and landside of the plow, where all is sliding friction.

Care should be taken in hitching that the horses are not too much crowded or spread too much, as in either case good work cannot be done. When spread too much the team cannot travel directly to the front so well, and the line of draft is too far out to do good work. When crowded, the horses are working at a disadvantage, and the heat in warm weather will affect them more. When not in use, the polished surface of a plow should be protected from rust by a coat of heavy grease or "axle grease," and, like all other implements, it should be protected from the weather.

## CHAPTER V

### TILLAGE MACHINERY (Continued)

115. **The smoothing harrow.**—After plowing the ground, it is necessary to pulverize the soil very finely and to smooth it. The harrow is the implement used for this purpose, and it may be used also to cover seeds, to form a dust mulch for retaining moisture, and to kill weeds when they are beginning to grow.

116. **Development.**—Formerly the branch of a tree of a size to suit the power, whether man or animal, was used as a harrow. The limb chosen had small branches extending usually all to one side or the other, so as to lie flat when in use. Even until quite recently the brush harrow has been in use for covering seeds. An early type of harrow consisted of a forked limb with spikes in each arm, to which a cross arm was added later. This form was known as the "A" harrow. Until late in the sixteenth century a type of harrow devised by the Romans was the standard. This harrow was square or oblong, having cross bars with many teeth in them.

117. **Classification.**—Harrowes may be classified as follows:

1. Smoothing harrows.
  - Kinds of teeth.....Straight fixed tooth;  
Square-and-round tooth;  
Cultivator tooth.
  - Kinds of frame.....Wood frame;  
Pipe frame;  
Channel or U bar frame.
  - Adjustment of teeth..Fixed tooth;  
Adjustable tooth;  
Lever harrows.

2. Spring-tooth harrows.
3. Curved knife-tooth harrows or pulverizers.
4. Disk harrows: Full disk; cutaway; spading; orchard.

It will not be possible to illustrate all these forms of harrows. The common **smoothing harrow** is not shown,

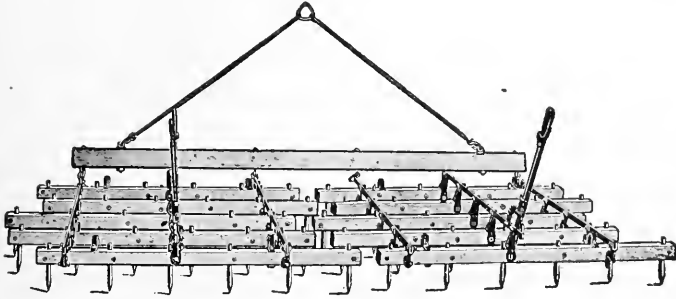

FIG. 50—A WOOD-BAR LEVER SMOOTHING HARROW. A CHEAPER HARROW IS MADE WITH FIXED TEETH AND A WOODEN FRAME

but a lever harrow with wooden bars is shown in Fig. 50. Wooden-frame harrows can be used to better advantage in trashy ground when they are provided with a tooth fastener so arranged that the teeth will slope backward

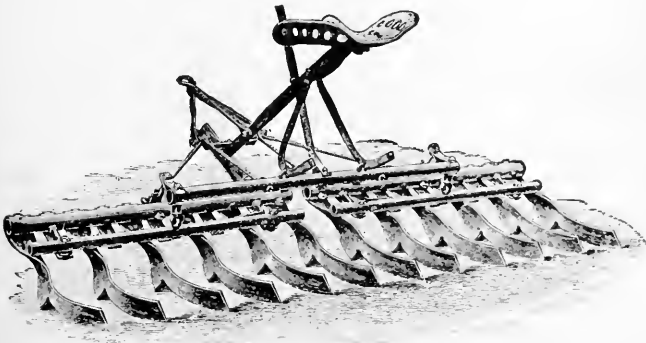

FIG. 51—A CURVED KNIFE-TOOTH HARROW OR PULVERIZER

when drawn from one end. Such teeth may be spoken of as **adjustable**. A curved knife-tooth harrow, sometimes spoken of as a pulverizer, is illustrated in Fig. 51. This

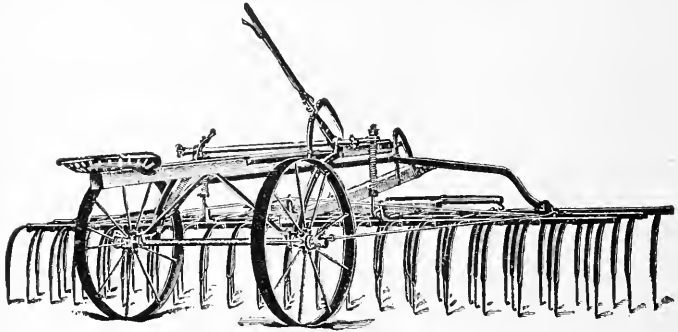

FIG. 52—A RIDING WEEDER

crushes clods and brings the soil into uniform structure very satisfactorily. The weeder has rather long teeth and is an excellent implement for destroying small weeds, and also to form a dust mulch and a fine tilth. The culti-

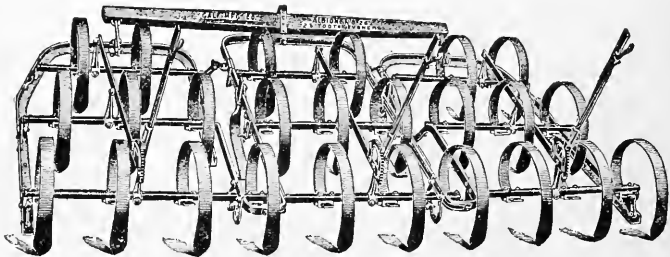

FIG. 53—A SPRING-TOOTH LEVER HARROW

vator tooth has the point flattened, and is curved so as to penetrate the ground more readily. Often it is aided in passing over obstacles by being held in place with a spring.

**118. The spring-tooth harrow.**—This harrow is illustrated in Fig. 53. When the teeth are caught on any obstacle they spring back and are released, this fact making it a very useful implement for stony ground. It is also an excellent pulverizer.

**119. The selection of a tooth harrow.**—It is a difficult matter to give explicit directions for selecting a harrow. The work to be done is the first thing to be considered, as a smoothing harrow, for instance, performs a very different office from a pulverizer or a weeder. Next the workmanship used in its manufacture and construction should be well examined. At all points where there will be much wear it should be well reënforced, and should have the general appearance of being a well-made tool. The connection between the sections of the evener especially should be properly reënforced, as the work of a single season has been known to wear out these connections. The tooth fastener is another important part in a tooth harrow which demands the attention of the purchaser. The tooth should have a head so that it will not drop out and be lost in case the fastener should become loosened. The square tooth is desirable, though spike teeth are made either from round or square stock. The regular sizes are  $\frac{1}{2}$  inch and  $\frac{5}{8}$  inch, the  $\frac{5}{8}$  inch size being suitable for heavier work. The number of teeth to the foot of the harrow may vary from five to eight, and this number as well as their size should correspond to the kind of work and conditions under which the harrow is to be used. Originally wooden harrow frames were the only kind used, but now they are generally made of steel pipe, angle and channel bars. The later styles of harrow are much more durable, and, the same amount of material being used, there is little choice between the styles of steel harrows. **Lever** harrows have an advantage in that

the angle of the tooth may be adjusted, making the implement capable of performing a variety of work. Some levers are more easily operated than others. This lever adjustment facilitates transportation. Some harrows are so constructed that the sections may fold upon each other for easy transportation. Harrows in which the ends of the tooth bars are protected are suited for orchard work, as the bars will not catch and bark the trees.

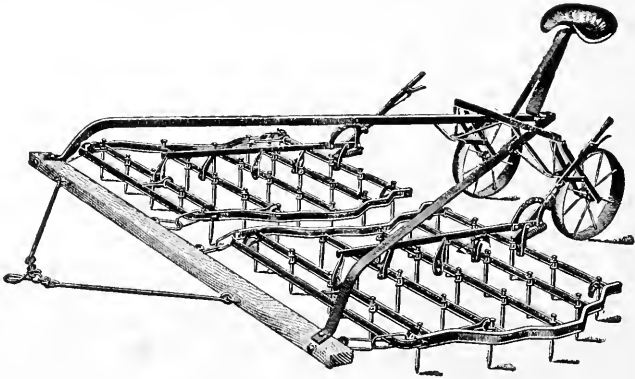

FIG. 54—A STEEL LEVER HARROW WITH A RIDING ATTACHMENT OR HARROW CART. THIS HARROW HAS THE TOOTH BARS MADE OF STEEL CHANNEL BARS WITH PROTECTED ENDS

**120. The harrow cart.**—In order that the operator may ride, this device is sometimes attached behind the harrow. The attachment is made to the eveners by angle bars, and the wheels are made to caster so that in turning it will follow the harrow. It is very laborious to walk behind the harrow on plowed ground, and the harrow cart removes this difficulty; at the same time the rider has easy control of the team and is above the dust. The extra draft should be very little, but the wheels should have wide tires to prevent them from cutting into the soft ground.



121. **The disk harrow.**—This tool is perhaps the best adapted for pulverizing and loosening the ground of any yet devised. On account of its rolling action, it can be used for a great variety of conditions. It does excellent service in reducing plowed ground which is inclined to be soddy, and may even be used to prepare hard and dry soils for plowing. It may also be used to advantage in destroying weeds after they have grown beyond the control of the smoothing harrow. In fact, the disk harrow should be in use on every farm.

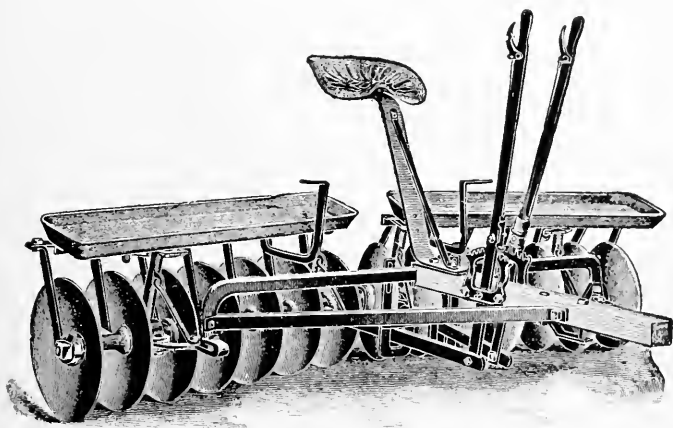

FIG. 55—A TWO-LEVER DISK HARROW. SCRAPERS OPERATED BY THE FEET

122. **The full-bladed disk harrow.**—This class of harrow may be used to good advantage as a pulverizer, and the blades are easily sharpened when dull, either by grinding or turning to an edge. The diameter of the disks may vary from 12 to 20 inches. For general purposes, the medium-sized, or 14- or 16-inch, disk is the size best adapted, although the larger sizes may have slightly less draft. The penetration of the disk blades into the ground

is determined by (1) the line of draft, (2) the angle of gangs, (3) the curvature of the disk blades, (4) the weight of the harrow, and (5) the sharpness of the blades.

**123. The cutaway or cut-out disk harrow.**—As may be judged from the name, portions of the periphery of the blade of this harrow are notched out, allowing the remaining portions to penetrate the ground to greater

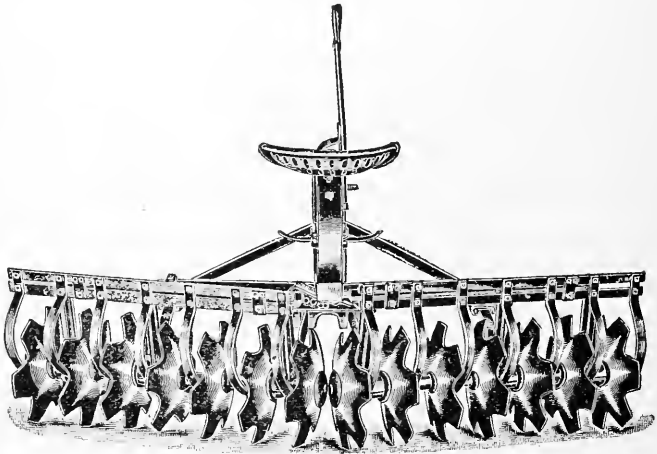

FIG. 56—A SINGLE-LEVER CUTAWAY DISK HARROW

depth. The entire surface, however, is not so thoroughly pulverized as with the full-bladed disk. It has a disadvantage of being hard to sharpen. The cutaway harrow seems to be especially adapted to work among stones and may be used to cultivate hay land.

**124. Spading harrow.**—This type of harrow has blades curving at the ends, forming a sort of sprocket wheel, with the cutting edges out. It works much like a cutaway. To sharpen it the blades must be separated and

drawn out much as a plow is sharpened. A special form of spading harrow with sharp spikes is used in cultivating

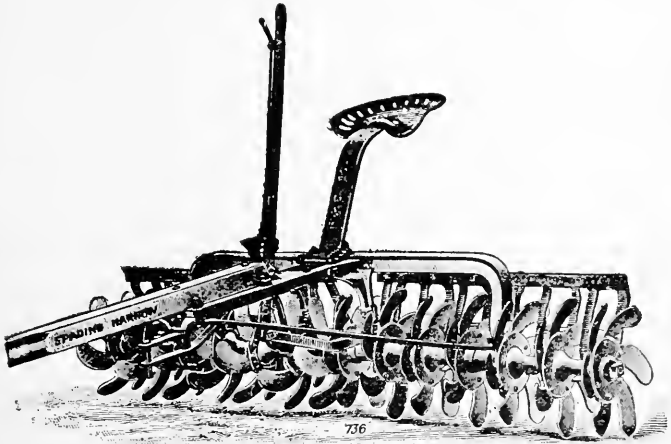

FIG. 57—A SPADING HARROW

alfalfa, and is given the name of “alfalfa harrow.” The orchard disk differs from the common disk only in that it has an extension frame, so that it may be used to

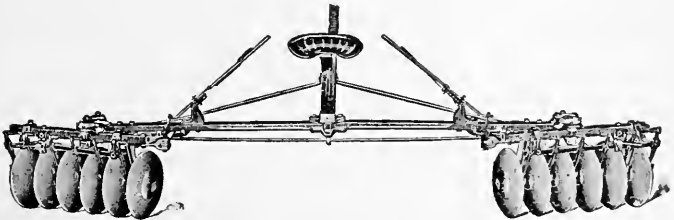

FIG. 58—AN ORCHARD DISK HARROW WITH WIDE FRAME TO WORK UNDER TREES. THE GANGS MAY BE SET TO THROW IN OR OUT

cultivate rows of small plants as well as to reach under trees and cultivate the soil under the branches. The disk

gangs often may be set to throw in or out from the center, to suit the nature of the work.

Usually the first parts of the disk harrow to wear out are the bearings. There are many styles of ball and chilled iron bearings in the market now, but those of hard wood seem to be as satisfactory as any, since they may be easily replaced. The construction of the bearings should be such as to exclude all dirt. A reliable means of oiling should be provided, and it is well to have an oil pipe to the bearings which extends above the weight pans or frame.

The scrapers or cleaners to keep the disks clean are another important feature of the disk harrow. These may be made stationary or so arranged as to be operated by the feet of the driver or otherwise when needed. They are not needed when working in dry soil, and when stationary they cause undue friction. A scraper that is made to oscillate by horse power over the face of the disk blades, and clean them automatically once in six revolutions, is sometimes used. When not needed it may be thrown out of gear.

Disk-harrows with bumpers to carry the end thrust of the sections are usually made with one lever in order that the gangs or sections may be adjusted and the bumpers kept squarely together. A scheme to surmount this difficulty is to adjust the outer end of the gangs only. A two-lever disk harrow offers several advantages by adjusting the gangs at different angles for side hill work and for double disking by lapping one-half each time. The soil when disked once is not as firm as the undisked ground, and if lapping one-half, it may be necessary to set the gangs at different angles in order to cause the harrow to follow the team well.

It is advisable to have good clearance between stand-

ards and the disks and between the weight boxes and the disks. Good clearance will prevent clogging in wet and trashy ground. In order to secure flexibility of the gangs it is almost essential to have spring pressure to keep the inside ends of the gangs down. There is a natural tendency for the gangs to raise at the center. If three horses are to be used, it is advisable to have a stub tongue and an offset pole. Patent three-horse eveners to remove side draft with the pole set in the center are not to be advised. A liberal amount of material must be used in the construction as well as good workmanship—for instance, a heavy gang bolt with a lock nut. A square gang bolt is considered better than a round one.

**125. Tongueless disk harrows** are now made with a truck under a stub-tongue. These harrows, no doubt, make the work lighter for the team, but sacrifice a certain amount of control in handling the harrow. This feature is of more importance under certain conditions than others. A tongue truck is also used and is a very satisfactory addition to the harrow.

**126. Plow-cut disk harrows.**—Harrows have been constructed for several years with disks which have a raised or bulging center, the idea being that the dirt in being forced up over the raised center is turned over much like it would be from the moldboard of a plow. It is claimed by the manufacturer that this shape enables the harrow to cover the small trash better, that it leaves the ground leveler, and the harrow has better penetration on account of the shape of the disk blades. All these claims are denied by other manufacturers.

### THE ROLLER AND PLANKER

**127. The land roller** is a very efficient tool for working up a fine tilth and for making the ground smooth and

firm. The first rollers were constructed out of suitable logs and were drawn by yokes engaging pins in the ends of the rollers. It was soon found that if a log of any width was used, it would not work well on uneven ground, and it was clumsy to turn. Rollers made in two or three sections were then introduced, which were found in a great measure to overcome these difficulties. If the soil moisture is to be conserved, the roller should be followed by a smoothing harrow,

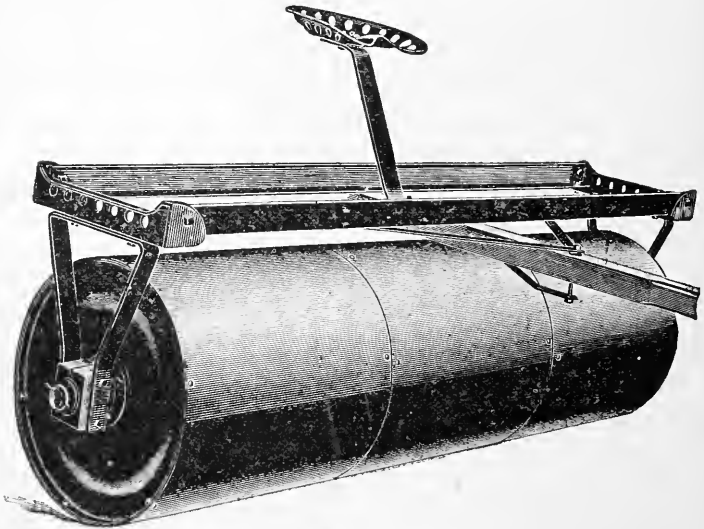

FIG. 59--A SMOOTH IRON ROLLER

as the former smooths and packs the ground, permitting the escape of the capillary water into the air. The harrow will roughen the surface, thereby decreasing the wind velocity, and will also put a dust mulch over the surface. The ground will be in much better condition for a mower or other machine after the roller has passed over it.

Certain advantages over the plain smooth rollers are claimed for the corrugated or tubular rollers, several styles of which have been invented. They are said to

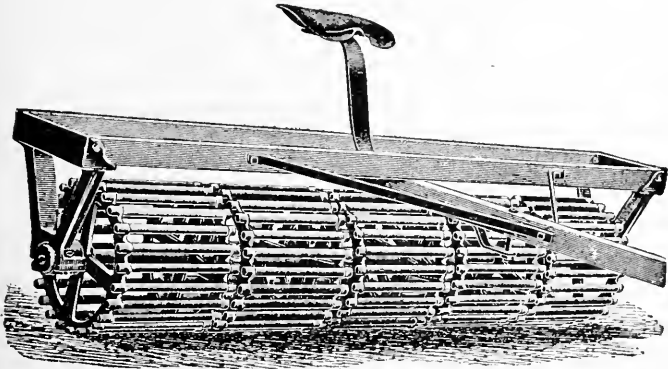

FIG. 60—A TUBULAR ROLLER

crush the clods better, and they do not leave a smooth surface. Figs. 60 and 61 illustrate two rollers of this



FIG. 61—A FLEXIBLE ROLLER AND CLOG CRUSHER OF SPECIAL DESIGN

type. H. W. Campbell invented a tool of this nature called the subsurface packer, for packing the ground beneath the surface. This tool (illustrated in Fig. 62) consists of a series of wheels with wedge-shaped tread.

Campbell advocates a method of surface cultivation to conserve the moisture in semi-arid regions. The intertillage of wheat and other small grains is included in this system. An authority states that rollers should be at least 2 feet in diameter, and should not weigh more than

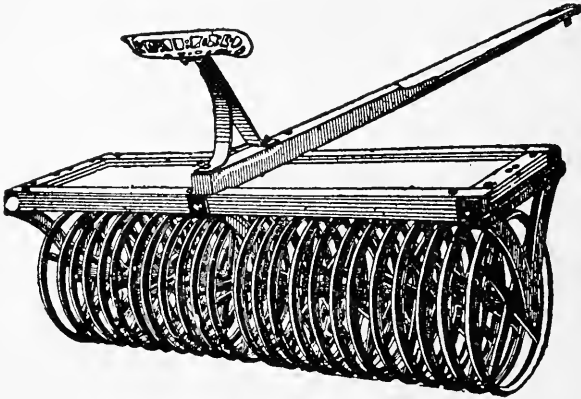

FIG. 62—THE SUBSURFACE PACKER

100 pounds to the foot of width. If intelligently used, the roller is no doubt a valuable implement to the average farm.

128. The common planker, although a home-made tool,

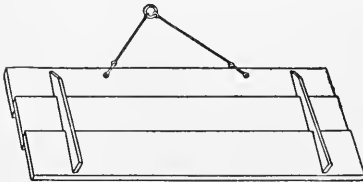

FIG. 63—THE COMMON PLANKER, A SERVICEABLE TOOL USUALLY MADE ON THE FARM

is a very valuable implement for crushing clods and smoothing the surface. It is not inclined to push surface clods into the soil like the roller, but will catch them and pulverize them. The planker does not adapt

itself well to any unevenness of the surface and does not pack the soil like the roller.



## THE CULTIVATOR

**129. Development.**—The modern cultivator, which is a very efficient aid to the cultivation of growing plants, has developed under the addition of animal power from a kind of crude hoe used in the early days. The original single shovel was changed for the double shovel, this in turn was supplanted by the straddle-row cultivator, and even the latter was increased in size until in some cases the modern cultivator will take two rows at a time. A horse hoe and drill was invented by Jethro Tull early in the eighteenth century, but this was never a popular machine. Until 1860 country blacksmiths generally made the double shovels used by farmers. A patent was granted to George Esterly, April 22, 1856, on a straddle-row cultivator for two horses, and his was the first of the line of implements in the manufacture of which millions are now invested.

### 130. Classification of cultivators.

- Single- and double-shovel cultivators.
- One-horse cultivators.
- Five- and nine-tooth cultivators.
- Straddle-row cultivators.
- Walking—
  - Tongue.
  - Tongueless.
- Riding.
- Combined.
- Single-row.
- Double-row.
- Surface cultivators.

**131. Single- and double-shovel cultivators,** although used very extensively at one time, have their use confined almost entirely to garden and cotton culture.

**132. The one-horse cultivator** is used largely in gardening and for cultivating corn too high to be cultivated with the straddle-row cultivator. It may be provided with almost any number of teeth from 5 to 14. The teeth may vary from the harrow tooth designed for producing a very fine tilth, to the wide reversible shovels used on

the five-tooth cultivators. Also a spring tooth may be used similar to those used on the spring-tooth harrow.

133. Features of cultivators, with suggestions in regard to selection.—The gangs (sometimes called rigs) are the beams, shanks, and shovels. Usually several styles of gangs may be fitted to each cultivator. The shovels may vary in number from four to eight for a pair of gangs. The larger number is to be preferred for producing the

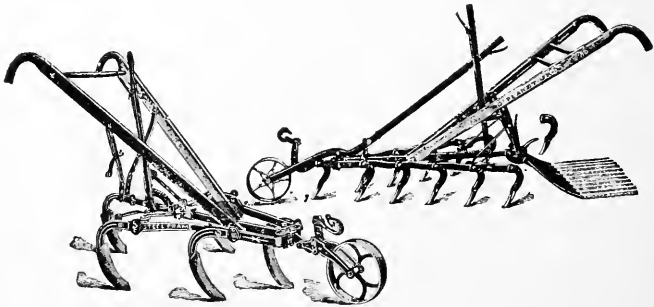

FIG. 64.—FIVE- AND ELEVEN-TOOTH ONE-HORSE CULTIVATORS. EACH HAS A LEVER FOR VARYING THE WIDTH, AND ALSO GAUGE WHEELS. ONE HAS A SMOOTHING ATTACHMENT

proper tilth of the ground, but are very troublesome in being easily clogged with trash. The six-shovel gangs are very popular for corn culture. The eight-shovel gangs may have each set of four shovels arranged either obliquely or in what is called a zigzag. Best cultivator shovels are made of soft-center steel. They are made of almost any width, and may be straight or twisted. The twisted shovel has a plow shape designed to throw the dirt to one side or the other, while the straight shovel must be adjusted on its shank to do this. The **beam** may be made of wood, steel channel, flat bar, or pipe. The wood beam is somewhat lighter, but not so strong or

durable. The **shanks** may be constructed of the same material as the beam and are provided either with a break-pin device or knuckle joint to prevent breakage when an obstruction is struck.

Flat springs may be used for the shanks, and when so used the term **spring tooth** is applied. Gopher shovels are arranged to take the place of a special surface cultivator. Such an arrangement is not generally satisfactory. A device is sometimes added to keep the shovels facing directly to the front. Such a gang is spoken of as having a **parallel beam**.

**Seats** are of two styles: the **hammock** and the **straddle**. The hammock seat is supported by the frame at each side and offers a good opportunity to guide the gangs with the feet. The straddle seat is more rigid, hence is well adapted to the treadle- or lever-guided cultivators.

The **pivotal tongue** is a device enabling the operator to vary the angle with which the tongue is attached to the cultivator frame. It may be used as a steering device, or to set the tongue at such an angle that the cultivator will not follow directly behind the team. It is very useful in side hill work where the cultivator tends to crowd down the hill. It may also be used in turning in a limited space.

The **expanding axle** permits the width of track to be varied, necessary on account of various widths of rows. It is accomplished by a divided steel axle or by the use of collars upon the axles. The divided axle permits of the use of the inclosed wheel box. It is an advantage to have the half axles reversible in that when the axle end becomes worn the opposite end may be substituted.

**Spacing.**—Some provision should be made to widen or narrow the spacing of the gangs or rigs. On single-row cultivators this is accomplished by slipping the couplings

in and out upon the front arch. The spacing in two-row machines should be accomplished by a lever which permits the change to be made while in operation.

**Suspension.**—The gangs should be so suspended as to swing freely in a horizontal plane. If the point of suspension is too far back and the suspending arm or chain too short, the shovels will be lifted out of the ground as

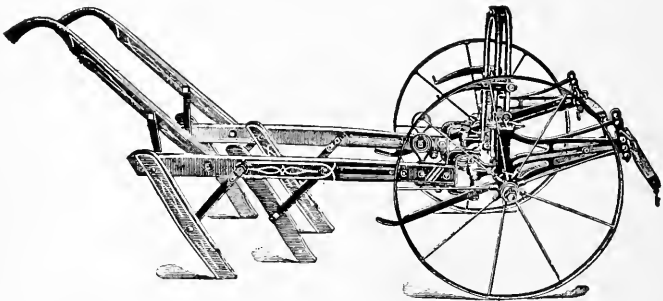

FIG. 65—A TONGUELESS FOUR-SHOVEL CULTIVATOR WITH WOODEN GANGS.  
THE SHOVELS ARE NOT IN PLACE

the gang is carried to either side. The farther ahead the gang is suspended and the longer the suspending arm, the more nearly the gang will swing in a plane. Considerable difference is experienced in the ease with which a long gang is guided compared with a short gang. This is due to the fact that as a short gang is swung to one side more work is done, as the shovels must be carried ahead; while with a long gang the shovels are not carried ahead to such an extent.

**Coupling.**—The double hinge joint by which the cultivator gang is attached to the frame is called the coupling. Due provision should be found in the coupling for taking up wear. It is impossible to guide properly a gang with much lost motion in the coupling.

**Raise of rigs.**—Springs should be provided to aid the operator in lifting the heavy rigs. Also these springs are often used to aid in forcing the shovels into the ground.

**Levers.**—In riding cultivators the lifting levers should

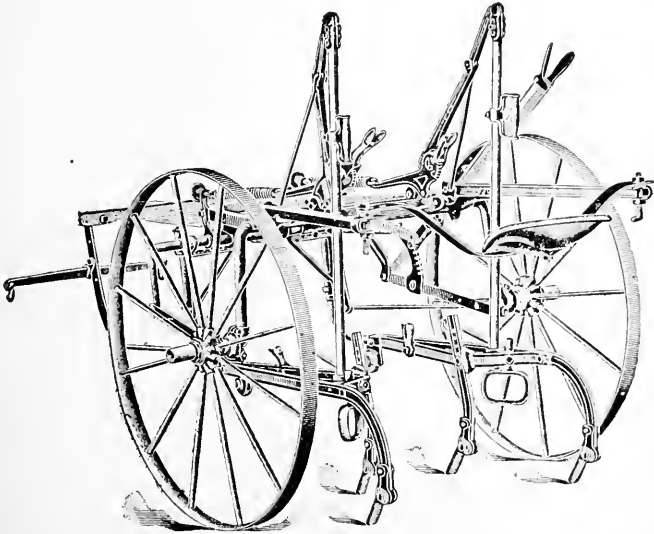

FIG. 66—A RIDING BALANCE-FRAME FOUR-SHOVEL CULTIVATOR WITH HAMMOCK SEAT AND STEEL GANGS

be so placed as to be easily handled from the seat. In two-row machines it is very essential to be able to work each gang independently in raising and lowering. In this way one gang may be freed from trash without molesting the others.

**Balance frame** is a name applied to cultivators so constructed that the position of the wheels may be so adjusted, either by a lever for the purpose or by the movement of the gangs, as to balance the weight of the driver and cultivator on the axle.

**Cultivator wheels** should be high and provided with wide tires.

**Wheel boxes.**—A notable improvement is found in the closing of the ends of the wheel boxes, making it possible to keep the bearings well lubricated.

The **spread arch** is a device to cause the gangs to swing in unison, and should be made adjustable in width.

**Hitch.**—It is a great advantage to have the height of hitch adjustable to horses of various sizes.

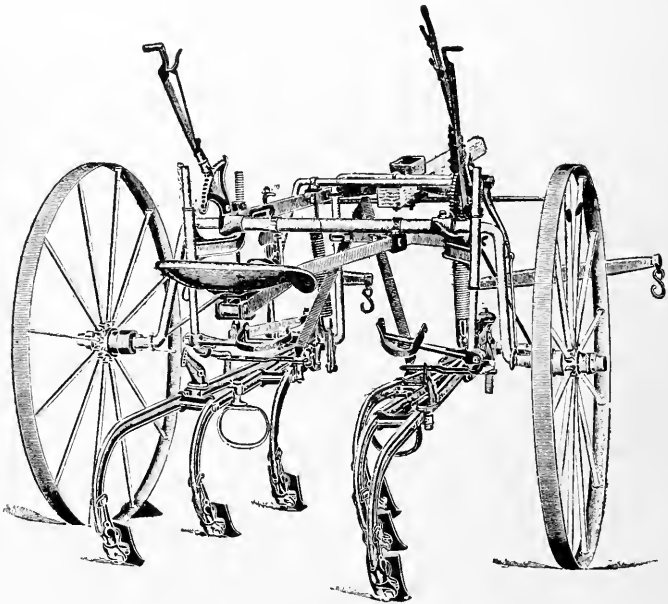

FIG. 67—A COMBINED WALKING AND RIDING SIX-SHOVEL CULTIVATOR WITH STRADDLE SEAT AND TREADLE GUIDE. THE HANDLES TO BE USED WHEN WALKING ARE NOT ATTACHED

**Treadle guide.**—Upon many cultivators a device has been added to guide the gangs as a whole by foot levers.

Such a device is called a treadle guide, and is often a very desirable feature.

**Pivotal wheels** are a scheme for guiding cultivators. The wheels may be connected to a treadle device or to a lever worked by the hands. This plan permits of an easy control of the cultivator.

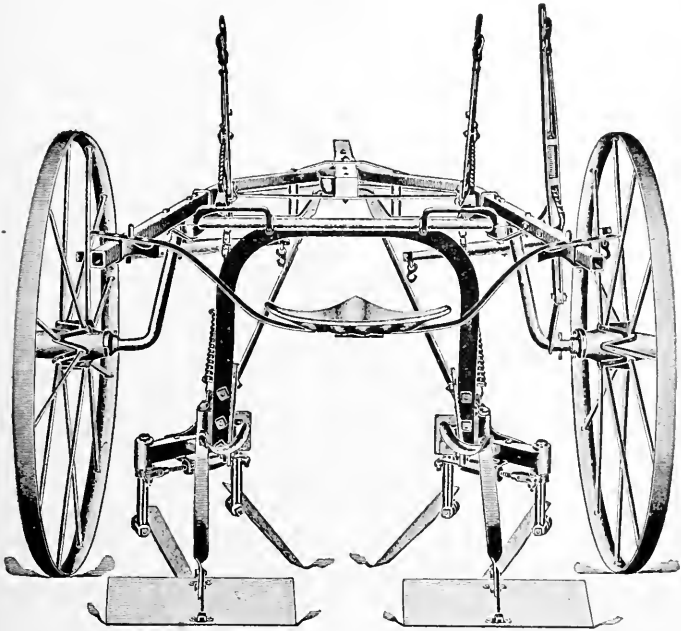

FIG. 68—A RIDING SURFACE CULTIVATOR

A walking, tongueless cultivator with four-shovel gangs is illustrated in Fig. 65. The tongueless offers one advantage in requiring less room for turning. It is essential that the team work very evenly to do good work. Fig. 66 illustrates a balance-frame six-shovel riding cultivator with a hammock seat. The wheels may be drawn

back by a lever when the gangs are lifted in order to be more directly under the weight and prevent the tongue from flying up.

The combined cultivator, walking and riding, is illustrated in Fig. 67. This cultivator has a straddle seat and a balancing lever to adjust for the weights of different riders.

The surface, or the gopher, cultivator (Fig. 68) is used for surface cultivation. It is very effective in destroying

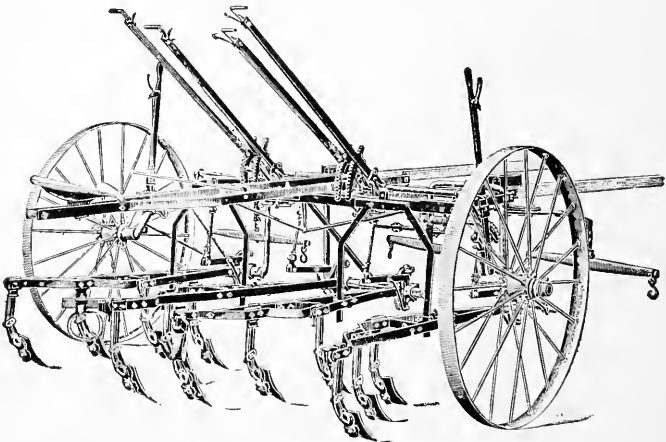

FIG. 69—A TWO-ROW CULTIVATOR, GUIDED WITH A LEVER

weeds when small, conserving the soil moisture, and does not prune the corn roots when working close to the corn.

The two-row cultivator is the latest production in the line of cultivators. It is a very useful tool where farm labor is scarce, and will do very creditable work for subsequent cultivations when the plants are of some height. Fig. 69 illustrates a cultivator of this type.

The disk cultivator illustrated in Fig. 70 is a tool which will move large quantities of dirt to or from the corn.



It is useful on this account for covering large weeds. Fig. 71 illustrates the eagle-claw gang, or the usual arrangement of shovels in the eight-shovel cultivator.

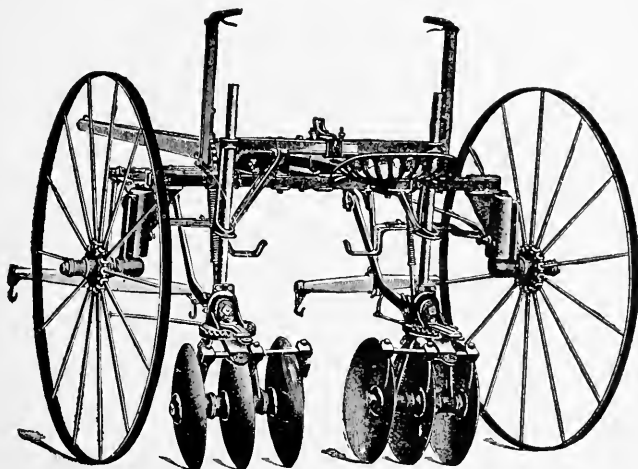

FIG. 70—A DISK CULTIVATOR

134. Listed corn cultivators.—For localities where the listing of corn is practiced, a cultivator has been

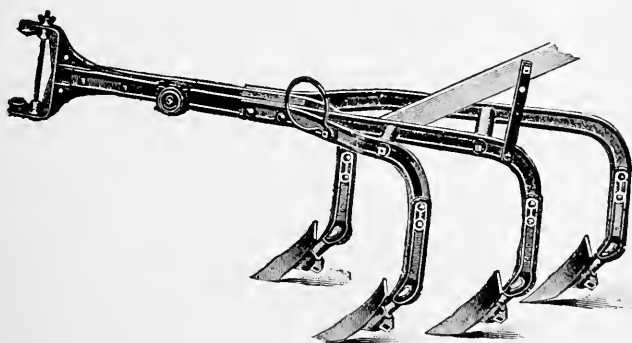

FIG. 71—AN EAGLE-CLAW FOUR-SHOVEL GANG

designed to follow the listed furrow for the first two cultivations. The machine is guided either by sled

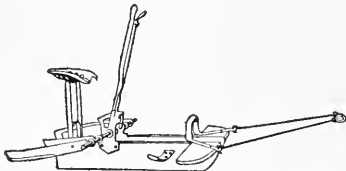

FIG. 72—A SIMPLE LISTED CORN CULTIVATOR. DISKS ARE OFTEN USED IN PLACE OF THE SCRAPERS. THE IMPLEMENT IS ALSO MADE TO CULTIVATE TWO ROWS AT A TIME

runners or roller wheels which run in the furrow. The shovel equipment varies between shovels and disks. The cultivator is made for one or two rows, and is a very successful tool.

in corn and cotton regions and which should be mentioned here is the stalk cutter. Its purpose is to cut cotton and corn stalks when left in the field into such lengths as not to interfere with the cultivation of the next crops. The implement, primarily consists in a cylinder with five to nine radial knives. It is rolled over the stalks,

135. **Stalk cutter.**—An implement in general use

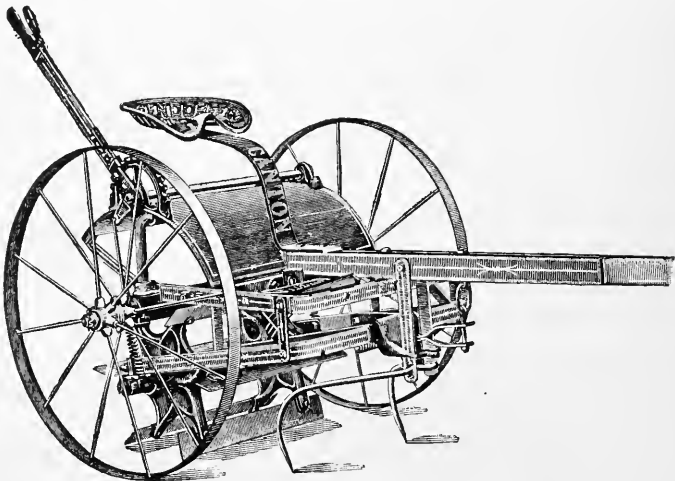

FIG. 73—A SINGLE-ROW STALK CUTTER

cutting them into short lengths. Stalk hooks are provided which gather the stalks in front of the cylinder. Two types are found upon the market, the spiral and the straight knife cutters. The spiral knife cutter carries practically all of the weight of the machine on the cylinder head while in operation, the side wheels being raised and the cylinder head brought in contact with the ground. Straight knife cutters have the cylinder head mounted in a frame, and when placed in operation are forced to the ground with spring pressure. The latter machine is much more pleasant to operate, as it rides more smoothly. Some cutters are equipped with reversible knives with two edges sharpened. A stalk cutter attachment is made for a cultivator carriage. The implement in general may be had as a single- or double-row machine.

## CHAPTER VI

### SEEDING MACHINERY

#### Seeders and Drills

**136. Development.**—Seeding by hand was practiced universally until the middle of the last century. Seed was either dropped in hills and covered with the hoe, or broadcasted and covered with a harrow or a similar implement. In fact, in certain localities in the United States hand dropping is practiced to some extent at the present time. Broadcasting seed by hand is practiced in many places.

A sort of drill plow was developed in Assyria long before the Christian era. Nothing definite is known of this tool, but it was evidently one of the crude plows of the time fitted with a hopper, from which the seed was led to the heel of the plow and drilled into the furrow. Just how the seed was fed into the tube we do not know. The Chinese claim the use of a similar tool 3,000 or 4,000 years ago.

Jethro Tull was perhaps the first to develop an implement which in any way resembles our modern drill. In 1731 he published a work entitled "Horse Hoeing Husbandry," in which he set forth arguments to the effect that grain should not be broadcasted, but should be drilled in rows and cultivated. This is, in a measure, like the system promulgated by Campbell, and which bears his name. Tull designed a machine which would drill three rows of turnips or wheat at a time. He used a coulter as a furrow opener and planted seed at three different depths. His reason for this was that if one seeding failed, the others coming up later would be sure to be successful. Tull, like many others who spent their lives in invention, died poor, but he was successful in developing a line of drills, horse-hoes, and cultivators.

**American development.**—The first patent granted to an American was that Eliakim Spooner in 1799. Nothing remains to tell us of the nature of this device. Many other patents followed

the first, but none are worthy of mention until a patent was granted to J. Gibbons, of Adrian, Michigan, August 25, 1840. Gibbons's patent was upon the feeding cavities and a device for regulating the amount delivered. A year later he patented a cylindrical feeding roll with different-sized cavities.

M. and S. Pennock, of East Marlboro, Pennsylvania, obtained a patent March 12, 1841, for an improvement in cylindrical drills. The patent pertained to throwing in and out of gear each seeding cylinder, and also to throwing the machine in and out of gear while in operation. These men manufactured their drill and sold it in considerable quantities.

Following the patent issued to the Pennock brothers came a long list of patents upon "slide" and "force-feed" drills. Slide drills are distinguished from the others in that a slide is provided to vary the size of the opening through which the seed has to pass, and in this way the amount of seed sown is varied. Force-feed drills carry the seed from the seed box in cavities in the seed cylinder, in which the amount is varied either by varying the size of seed pockets or by varying the speed of the seed cylinder.

The first patent upon a force-feed grain drill was issued November 4, 1851, to N. Foster, G. Jessup, H. L. and C. P. Brown, and was the introduction of the term force feed. In 1854 the Brown brothers incorporated as the Empire Drill Company and established a factory at Shortsville, New York. In 1866 C. P. Brown devised and patented a modification which has been known ever since as the "single distributor." One of Brown's employees, in connection with a Mr. Beckford, removed to Macedonia, New York, and in 1867 took out several patents which presented the "double distributor." The double distributor was a seed wheel with a flange on each side, one with large cavities and the other with small to suit the different sizes of grain. This system was adopted by the Superior Drill Company, of Springfield, Ohio. In 1877 a patent was granted to J. P. Fulghum for a device for varying the length of the cavities of the seed cylinder, and thus varying the amount of seed drilled. This principle is now used by many manufacturers.

The first drills were provided with hoes, but later a shoe was found to be more satisfactory. Perhaps the shoe was introduced by Brown, who devised the shoe for corn planters.

## 137. Classification of seeders.

Broadcast seeders:

- . Hand, rotating distributor.
  - Wheelbarrow.
  - End-gate, rotating distributor.
- Wheeled broadcast:
- Wide track. Narrow track.
  - Agitator feed. Force feed.
  - Combination with cultivator.
  - Combination with disk harrow.

138. The hand seeder with rotating distributor consists of a star-shaped wheel which is given a rapid rotation either by gearing from a crank or by a bow, the string of which is given one wrap around the spindle of the

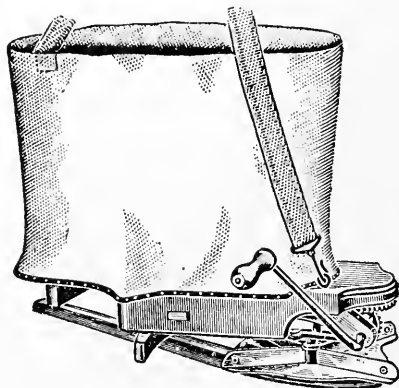

FIG. 74—A CRANK HAND SEEDER. SEEDERS OF THIS KIND ARE ALSO OPERATED WITH A BOW

distributing wheel. Fig. 74 shows a seeder of this order. A bag is provided with straps which may be carried from the shoulders and the distributing mechanism placed at the bottom. The use of this seeder is confined to small areas, and the uniformity of its distribution of the seed is not the best.

139. The wheelbarrow seeder is used to some extent for the sowing of grass seed, and seems to be the survivor of this type of seeder, which was at one time used exten-

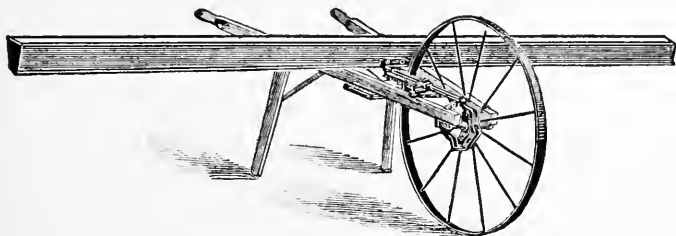

FIG. 75—A WHEELBARROW SEEDER

sively in England. A vibrating rod passes underneath the box and by stirring causes the seed to flow out of the openings on the under side of the seed box.

140. The end-gate seeder is provided with a rotating or whirling distributor much like the hand machine first described. Formerly nearly all of this type of machine

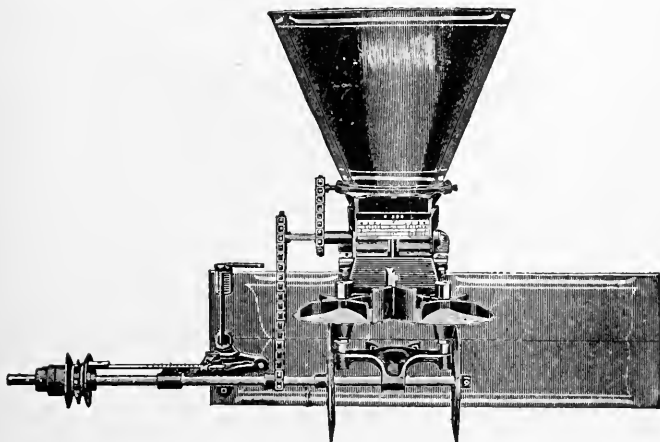

FIG. 76—AN END-GATE SEEDER WITH A FORCE FEED AND FRICTION GEARING. THIS MACHINE HAS TWO SEED DISTRIBUTERS

had only one distributor, but now the better makes are provided with two and a force-feed device to convey the seed to the distributor. Power to operate the seeder is obtained from a sprocket bolted to one wheel of the wagon on which the seeder is mounted, and transmitted to the seeder with a chain. The distributor is geared either by bevel or friction gears. It is stated that the friction gear relieves the strain on the machine when starting, and also runs noiselessly. The bevel gear drive

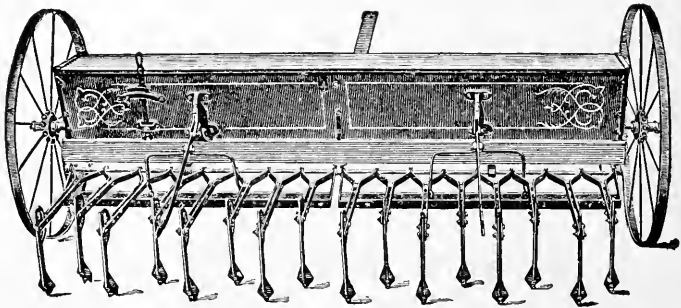

FIG. 77—AN AGITATOR-FEED BROADCAST SEEDER WITH CULTIVATOR COVERING SHOVELS. THIS IS A WIDE-TRACK MACHINE

is more durable and is recommended as being preferable by manufacturers who manufacture both styles of gears.

The same criticism may be made of this machine as of the hand machine. The distribution of the seed is not the best, and great accuracy in seeding is not possible. As the seeder is high above the ground, the wind hinders the operation of the machine to such an extent as to prevent its use in anything but a light wind or calm. In order to secure greater accuracy, the seed in some makes is fed the distributor by a force-feed device. A small seeder of this type has been arranged to be placed upon



a cultivator to sow a strip of ground the width of the cultivator as the ground is cultivated. This seeder has not as yet reached an extended use.

**141. Agitator feed.**—A broadcast seeder is still upon the market not provided with a force feed, but having what is known as an agitator feed. This feed is composed of a series of adjustable seed holes or vents in the bottom of the hopper, and over each is an agitator or stirring wheel to keep the seed holes open and pass the seed to them. The agitator feed, although cheaper and more simple than others, is not so accurate as the force feed described later.

Fig. 77 illustrates a broadcast seeder with an agitator feed and cultivator gangs attached. This seeder is usually used without any covering device; however, it may be procured with the cultivator gangs or with a spring-tooth harrow attachment.

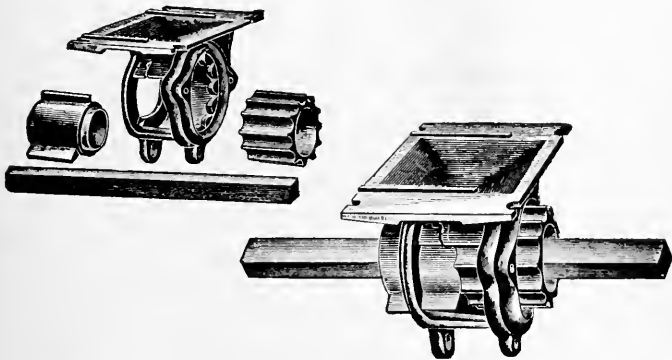

FIG. 78—A FORCE-FEED DEVICE. THE FEED IS VARIED BY EXPOSING MORE OR LESS OF THE FLUTED FEED SHELL

**142. Force-feed** seeders and drills derive their name from the manner in which the grain is carried from the

seed box. A **feed shell** is provided which is attached to a revolving shaft receiving its motion from the main axle.

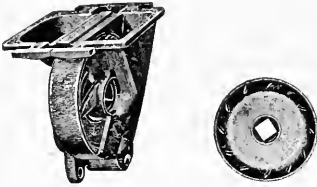

FIG. 79—ANOTHER TYPE OF FORCE FEED

Fig. 78 shows the most common force-feed device. In the fluted cylinder, the device illustrated, the feed is regulated by exposing more or less of the cylinder to the grain. The feed shell is also designed in other ways. The

seed cells may be on the inside and without any means of regulating the size of the cell. The feed or the amount of seed is regulated by varying the speed of the shaft carrying the feed shells by gearing as shown in Fig. 80.

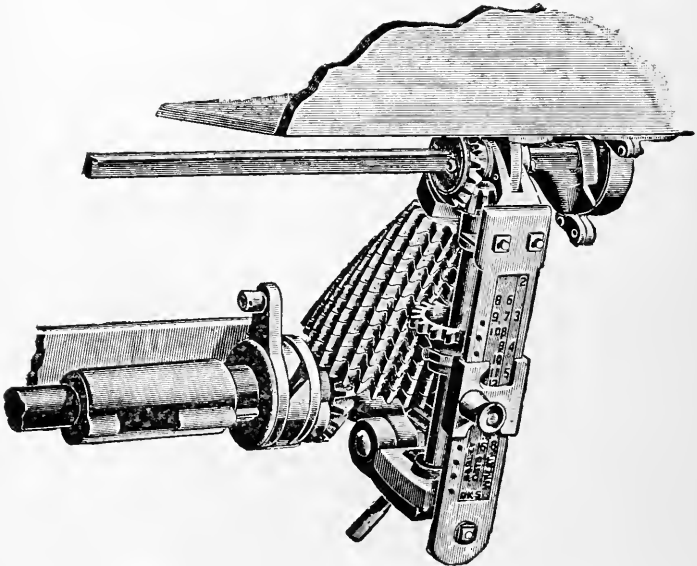

FIG. 80—A FEED-REGULATING DEVICE USED IN CONNECTION WITH A FORCE FEED SIMILAR TO THAT SHOWN IN FIG. 79

In order to handle successfully seeds of different size, the feed shell is made with two flanges with seed cells

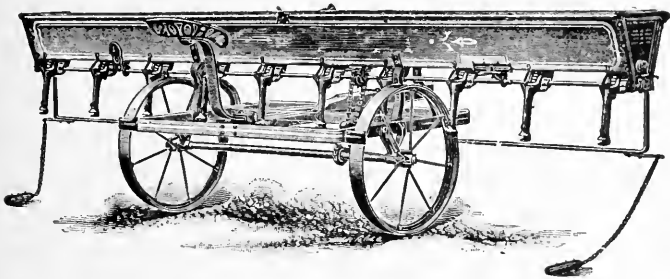

FIG. 81—A FORCE-FEED BROADCAST SEEDER WITH NARROW-TRACK TRUCK of different sizes in each. The cells best suited to the grain drilled are used, while the others are covered.

143. Width of track.—Broadcast seeders are now made

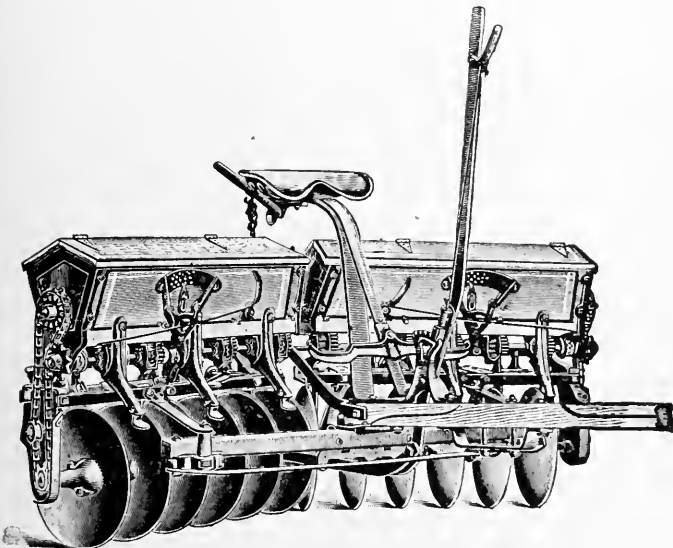

FIG. 82—A COMBINED DISK HARROW AND SEEDER. THIS MACHINE MAY ALSO BE SET TO DRILL FROM SEED SPOUTS AT THE REAR

with either wide or narrow track. Perhaps the wide track is the stronger construction and permits of higher wheels, but the narrow track permits of greater ease in turning and there is not the tendency to whip the horses' shoulders as with the wide track.

**144. Combination seeders.**—Broadcast seeders with cultivator and spring-tooth harrow attachments have been referred to. A popular tool now is the seeder attachment for the disk harrow. This attachment resembles very closely the force-feed broadcast seeder mounted above each of the harrow sections, and is operated by suitable sprocket wheels and chain from the main shaft of the disk. By the use of this tool two tools may be combined in one. The disk gangs, owing to their tendency to slip occasionally, do not make an entirely satisfactory drive. This is especially true in trashy ground. To surmount this difficulty, combination seeders are made with a follower wheel to drive the seeder.

## DRILLS

Drills are provided with a force feed much like those used upon seeders, but are distinguished from each other in the type of furrow opener and covering devices used.

### 145. Classification of drills.

Furrow openers:

Hoe.

Shoe.

Single-disk.

Double-disk.

Covering devices:

Chains.

Press wheels.

Press wheel attachment.

Interchangeable disk and shoe drills.

**146. The hoe drill** was the first to be developed, and it is not difficult to see why this should be. The

hoes are provided with break pins or spring trips in order that they may not be broken when striking an obstruction. These trip devices resemble very much those used upon cultivators. The hoe drill has good penetration, but clogs badly with trash. It is used extensively as a five-hoe drill for drilling in corn ground between rows of standing corn.

147. The shoe drill came into use about 1885 and has many advantages over the hoe drill. In fact, it was used almost entirely until the more recent development in the nature of the disk drill. Fig. 83 illustrates a shoe drill with high press wheels. The shoes are pressed into the ground with either flat or coil springs, which permit an independent action and prevent to a certain extent clogging with trash. It is claimed that flat springs do not tire as readily as coil springs, but coil springs seem to be almost universally used.

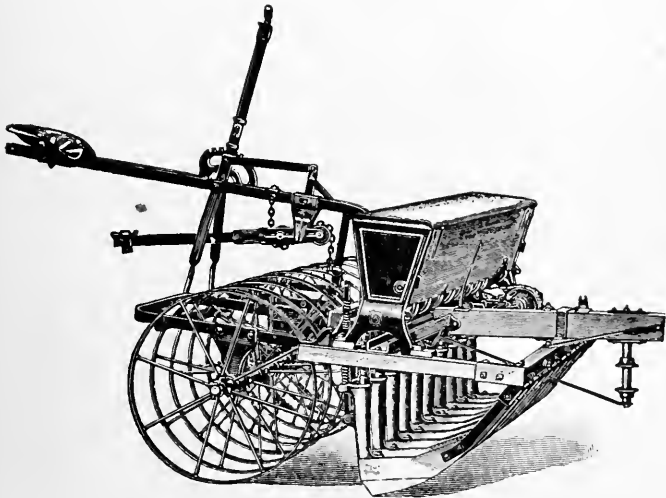

FIG. 83—A LOW-DOWN PRESS DRILL WITH SHOE FURROW OPENERS

148. **Disk drills** are the more recent development and consist of two classes: those with single- and double-disk furrow openers. In the single-disk type the disk is formed much like those used on disk harrows. Some form of heel or auxiliary shoe is provided to insert the grain in the bottom of the furrow made. It is desirable that the passage for the seed be so arranged that there can be but little chance for it to become clogged with dirt. The furrow opener that allows the seed to come into direct contact with the disk is not to be advised, but an inclosed boot should be provided to lead the seed into the bottom of the furrow. Some ingenuity is displayed by different makers in securing the desired results in this respect. In some drills the grain is led through the center of the disk. The single-disk may be given some

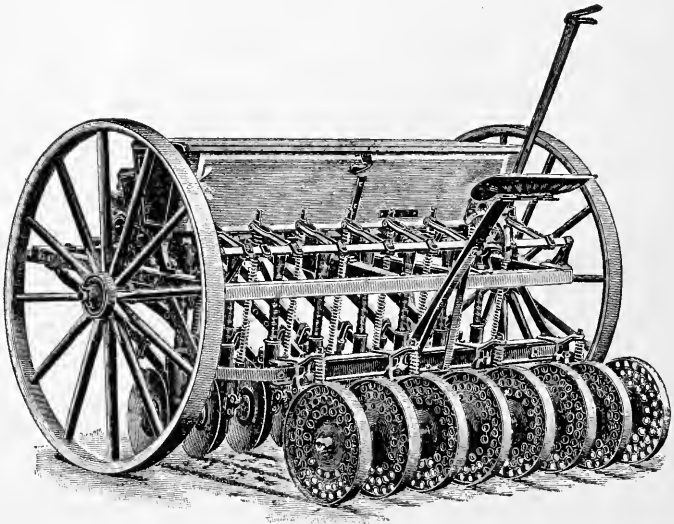

FIG. 84—A STANDARD SINGLE-DISK DRILL WITH A PRESS-WHEEL ATTACHMENT. THE STEEL RIBBON SEED TUBES ARE ALSO SHOWN

suction, and therefore has more penetration than any other form of disk opener, fitting it especially for hard

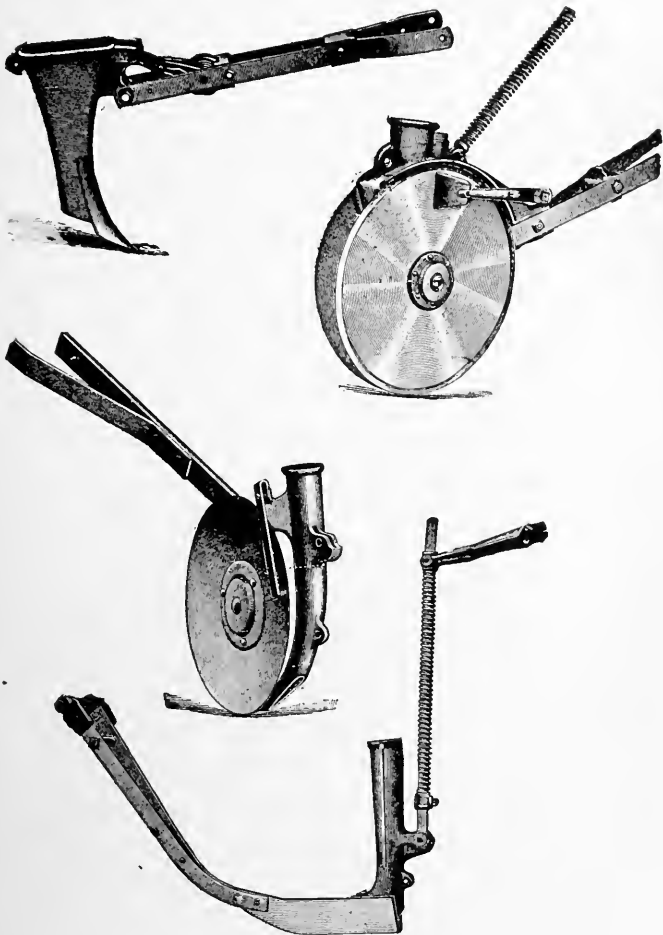

FIG. 85—THE HOE, DOUBLE-DISK, SINGLE-DISK, AND SHOE FURROW OPENERS USED ON DRILLS. THESE ARE OFTEN MADE INTERCHANGEABLE

and trashy ground. The single disk has one objection, and that is that it tends to make the ground uneven, since the soil is thrown in only one direction.

The double-disk furrow opener has two disks, or really coulters, as they are flat and their action is much like that of the shoe. One disk usually precedes the other by a short distance. The double-disk has not the penetration of the single-disk, but will not ridge the ground as the single-disk does. They often have another bad feature in that they allow dry dirt to fall on the seed, and hence prevent early germination. The single-disk drill does more to improve the tilth of the ground than any other furrow opener. The fact that a slight ridge is left in the center of the furrow with the double-disk is considered by some an advantage, as the seed is better distributed; in fact, two rows are planted instead of one.

**149. Interchangeable parts.**—Most manufacturers now design their drills in such a way that any one of the various styles of furrow openers may be used. Fig. 85 shows furrow openers which may be used on the same drill.

**150. Press wheels.**—Not a few years ago drills were equipped to a large extent with press wheels, but now they are not so popular. The press wheel, when sufficient pressure can be applied, is evidently a very good thing, as the earth is compacted around the seed and the moisture is drawn up to the seed, causing early germination. The pressure upon each press wheel must necessarily be very small, as most of the weight of the drill is required to force the furrow openers into the ground, and the balance is to be divided over a number of press wheels. It is not an uncommon thing to see an old drill running with some of the press wheels entirely off of the ground. Drills have been made in two distinct types, one



known as the standard drill with the large wheels at the end of the seed box and equipped with small press wheels, and another where large press wheels were used and the large wheels at the end of the seed box dispensed with, which is spoken of as a **low-down** drill.

**151. Press-wheel attachment.**—In order to make their machine become more universal, manufacturers have provided press-wheel attachments for those who wish them, and they are detachable and do not interfere with the use of the drill whether with or without them. It is to be mentioned here that the drill has many conditions to meet, and a drill which will do satisfactory work in one section may not in another. Thus in a wheat territory, where the ground is not plowed every year and a drill with great penetration is needed. In other sections where the ground is carefully prepared this particular feature is not so important. Press-wheel attachments are a nuisance in turning, and it is out of the question to back the machine.

**152. Covering chains.**—Chains are often provided to follow after the furrow openers, and their sole purpose is to insure a covering of the grain.

Formerly the grain tube or the spouts which convey the grain to the furrow opener were made of rubber, but the best used at the present time are made either of steel wire, or, still better, steel ribbon.

**153. Disk drills.**—Indications point toward the displacement of all forms of furrow openers by the single-disk opener. The single-disk will meet nearly all of the many conditions to be encountered. The double-disk is not much better in many respects than the shoe. The single-disk has good penetration, and besides is especially well adapted to cut its way through trash. Against it stand two objections: One is that there is a tendency for

it to clog when the ground is wet, and the other is its weak point, the bearing. With the shoe drill, the wear is upon the shoe itself, but with the disk there is a spindle, and being so close to the surface of the soil, it is in a bad place to keep free from dirt and to lubricate. The bearings in use consist almost universally of chilled iron. Wood has proved itself to be especially well adapted for

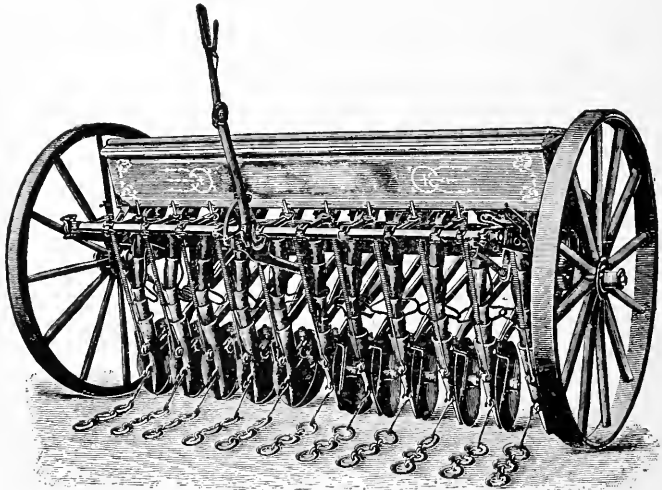

FIG. 86—A STANDARD SINGLE-DISK DRILL WITH COVERING CHAINS

a place of this kind, but does not seem to be used. At any rate, in the purchase of a drill a close inspection should be made of the bearings to see that they are so designed as to give a large wearing surface, to be as nearly as possible dust proof, and to be provided with the proper kind of oil cups or other device for oiling.

154. **Distance between furrow openers.**—Drills are usually made 5, 6, or 7 inches between furrow openers. Perhaps 6 inches is the width generally used. They are

placed 14 to 16 inches or more apart in the Campbell system, and then the grain cultivated during the growing season. It is thought desirable by some to have a slight ridge between the rows in order to hold the snow and to protect the young plant seeded in the fall from being affected so much by heaving. The action of the wind is to wear the ridges down, and in this way tend to cultivate the plants.

**155. Horse lift.**—The gangs of drills are very heavy and somewhat difficult to handle with levers, the levers being called upon to force the furrow openers into the ground while at work. To assist in this an automatic horse lift is provided on the larger drills.

**156. Footboard.**—To replace the seat a footboard is often placed on the drill. The operator in this case rides standing and is in a handy position to dismount.

**157. Grass-seed attachment.**—The feed shell arranged to drill the larger field grains does not have the refinement to drill grass seed with accuracy. It is often desired to drill the grass seed at the same time as the grain, and good results cannot be had by mixing and drilling together. The grass-seed attachment does not differ much from other devices except in size. Grass-seed attachments are often poorly constructed and become so open as to prevent their use after a few years' service.

**158. Fertilizer attachment.**—Practically all drill manufacturers can now furnish their machines with an attachment for drilling commercial fertilizer at the time of seeding. The fertilizer is usually fed by means of a plain rotating disk, which carries the fertilizer out from under the box. The seed mechanism will not work with fertilizer, as there is a great tendency to corrode on the part of some of the fertilizers.

**159. The five-hoe or disk drill.**—This tool is used for

putting fall grain in corn ground while the corn is standing. The disk drill has been displacing the hoe drill because it does not clog as easily with corn leaves. Fig. 87 shows a five-disk drill with a footboard so arranged that the operator may ride when it is necessary to add his weight to secure greater penetration.

**160. Construction.**—In purchasing a drill it might be well to investigate the construction. The implement, be-

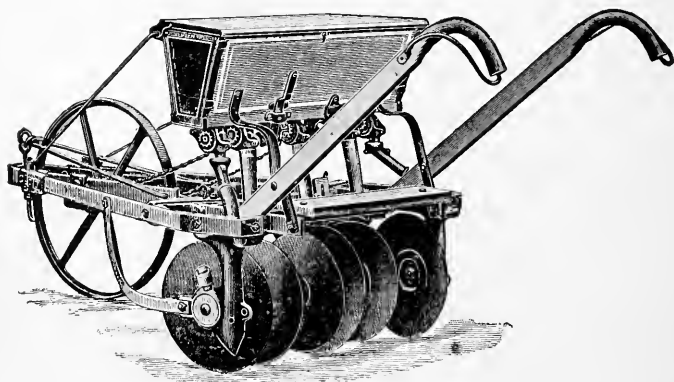

FIG. 87—A FIVE-DISK DRILL FOR DRILLING BETWEEN CORN ROWS. THE CENTER FURROW OPENER IS A DOUBLE DISK

cause it is so heavy and often wide, should be provided with a strong frame. Angle bars or either round or square pipes are used to make the main frame. The frames are often provided with truss rods in order to stiffen them as much as possible. Some of the heavier drills are now made with tongue trucks much like disk harrows referred to in a preceding chapter. They are a very satisfactory addition.

**161. Draft of drills.**—Drills are not as a rule light of draft for the number of horses used. The following re-

sults are given from experiments made at the Iowa experiment station:

Drill	Kind of Disk	Distance Apart at Drill Rows	No. of Disks	Distance covered in Feet	Total Draft in Pounds	Draft per Foot
No. 4.	Double.....	8"	10	6.7	450	67.1
No. 5.	Single.....	8"	10	6.7	460	68.6

Neither of the above drills was provided with any form of covering device other than chains. It is to be noted from the above tests that the single-disk drill requires more power than the double-disk in pulverizing the ground, but the difference is small.

**162. Calibration.**—The scales or gages placed upon driller and seeders to indicate the amount of seed drilled per acre are not as a rule to be depended upon for great accuracy. If they are correct at first, there is a tendency for them to become inaccurate as the drill becomes old. The operator should make calculations of the ground drilled and the amount of grain used, and in this way check the scale of the drill. Drills calibrated have shown the scale to be in error as much as 25 per cent.

**163. Clean seed.**—The drill is displacing, to a large extent, the broadcast seeder because the farmer desires to place all of the seed in the ground and at the proper depth. With the broadcast seeder, where various methods of covering of the seed are resorted to, the seed cannot be covered a uniform depth. Practically all fall seeding is now done with drills, and the broadcasting is used for the seeding of spring grains alone. Experiments at the Ohio, Indiana, North and South Dakota stations give, without an exception, better results from drilling, the increased yields for the drilling being from 2 to 5 bushels. In order to have a drill do its best work, great stress should be laid upon the fact that all grain should be clean

and especially free from short lengths of weed stems, which are often found in grain as it comes from the threshing machine. These stems or pieces of straw may lodge in the feedway and prevent the grain from getting into the seed wheel.

### CORN PLANTERS

**164. Development.**—Corn planters are strictly an American invention. This is not strange, for corn, or maize, is peculiarly an American crop. The development of the planter has also been recent; not much over 50 years have elapsed since the planter has been made a success. The Indians were the first to cultivate corn, but they never had anything but the most primitive of tools. Until the development of the horse machine, corn was almost universally planted and covered by means of the hoe, and in localities where a very limited amount of corn is grown the method is followed to-day.

The first machines used for seeding were universal in the respect that they were used for the smaller grains as well as corn. Perhaps the first patent granted on what may be styled a corn planter was given March 12, 1839, to D. S. Rockwell. In this planter may be seen in a somewhat primitive form some of the features of the modern planter. The furrow openers were vertical shovels, and the planter was supported in front and in the rear with wheels with the dimensions of rollers. The corn was dropped by means of a slide underneath the box. The jointed frame was patented by G. Mott Miller in 1843. George W. Brown, of Galesburg, Illinois, devoted much of his time to the development of the corn planter and secured patents on many features. To Brown's efforts is credited the shoe furrow opener, the rotary drop, and a method of operating the drop by hand. A patent on a marker was granted to E. McCormick in 1855 as a device projecting from the end of the axle. The present marker was set forth in a patent secured by Jarvis Case, of Lafayette, Indiana, in 1857. In about 1892 the Dooley brothers, of Moline, Illinois, brought out the edge-selection drop used extensively on the more recent planters.

**165. Development of the check rower.**—It seems that all the early planters were automatic, in that an operator was not needed to work the dropping mechanism. In 1851 a patent was

granted to E. Corey, of Jerseyville, Illinois, for a device to mark the point where the corn was planted, and this device led to the use of a marker in laying off fields and putting the hills of corn in check. Brown's patent previously referred to was the first patent to cover the hand-dropping idea. M. Robbins, of Cincinnati, patented in 1857 a checking device for a one-horse drill using a jointed rod and chain provided with buttons for a line. The check rower was developed to a practical device by the Haworth brothers. The Haworth was for a long time the standard machine. The check wire in this implement was made to travel across the machine. Among the first of the side-drop check rowers was the Avery, which became at one time very popular. Recent changes in check rowers have been confined to reducing the amount of work done by the machine.

166. **Hand planters** have never come into any extended use, as they are not any great improvement over the hoe. This planter is made now much like it was years ago. Fig. 88 shows the common style and is used to some extent in replanting. A slide extends from one handle to the other and passes under the small seed box. When the slide is under the box a hole of the proper size is filled with the desired number of grains. When the handles are opened so as to close the points the hill of corn is drawn from under the seed box and allowed to fall to the point. There are modifications of this hand planter in which a plate is used

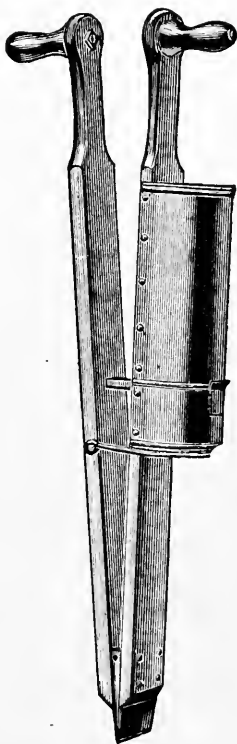

FIG. 88—A HAND CORN PLANTER. THE CORN IS DRAWN FROM UNDER THE SEED BOX BY A SLIDE UPON CLOSING AND OPENING THE HANDLES

and made to revolve by pawls which act by opening and closing the planter.

**167. The modern planter.**—Although most planters are called upon to do about the same work, they differ much in construction. The essentials of a good, successful

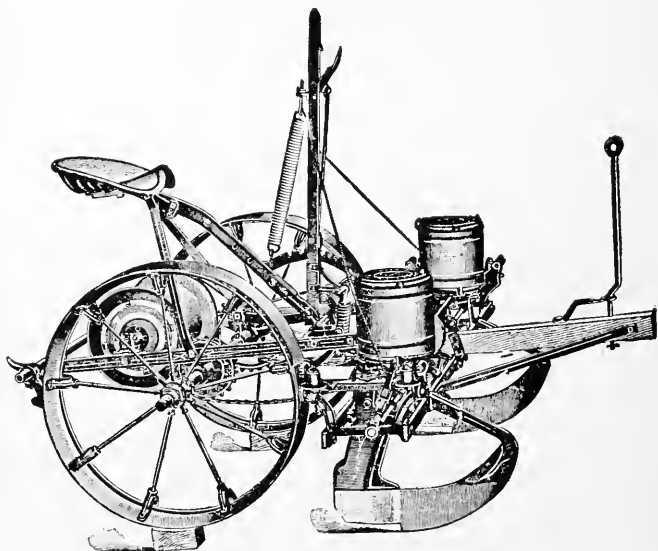

FIG. 89—A MODERN CORN PLANTER WITH LONG CURVED FURROW OPENERS, VERTICAL CHECK HEAD, AND OPEN WHEELS

planter have been set forth as follows: (1) It must be accurate in dropping at all times; (2) plant at a uniform depth; (3) cover the seed properly; (4) convenient and durable; and (5) simple in construction.

**168. Drops.**—The early planters had slides or plates in which holes or seed cells were provided which were large enough to hold a sufficient number of kernels to make an entire hill of corn. Planters are constructed in this



manner and offer some advantages in dropping uneven seed. This style of drop is known as the **full-hill drop**.

The **cumulative drop** was the result of an effort to raise the accuracy of dropping. In the cumulative drop the grains are counted out separately (a seed cell being provided in the seed plate for each kernel) until a hill is formed, the theory of the accuracy being that there is less chance for one less or more kernels when the cell is nearly

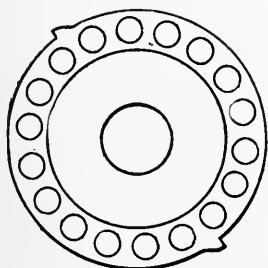

FIG. 90—THE ROUND-HOLE SEED PLATE

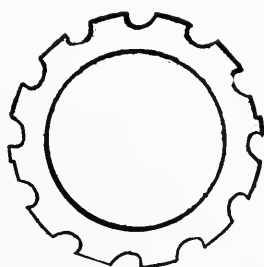

FIG. 91—THE EDGE-SELECTION PLATE

the size of each kernel, while in the larger cell three small kernels could easily make room for the fourth.

**169. Plates.**—The **round-hole** plate is a flat plate with round holes for seed cells; hence the name. The round-hole plate may belong to a full-hill or a cumulative drop planter.

The **edge-selection** or edge drop plate has deep narrow cells arranged on its outer edge, in which the corn kernel is received on its edge (Fig. 91). The arguments advanced in favor of this plan are that the corn kernel is more uniform in thickness than any other dimension, and owing to the depth of the cells is not so apt to be dislodged by the so-called cut-off. The majority of planter manufacturers within the past few years have brought out an

edge-selection drop-plate planter and claimed great accuracy for it. Varieties of corn differ very much in the width of kernel, and for this reason provision has been made by at least one manufacturer to vary the depth of the edge-selection cell by substituting grooved bottoms to the seed box over which the plate travels. A device is provided with the flat plate for the same purpose. The outside edge of the cell is made open, into which a spring fits, excluding all but one kernel.

**170. Plate movement.**—Plates are made to revolve in a horizontal plane, and also in a vertical plane. To plates in these positions the names of **horizontal plate** and **vertical plate** are given, respectively.

The **intermittent plate movement** is one where the plate is revolved until a hill is counted out, and then remains at rest until put in motion for another hill by the check wire. The movement may belong to full-hill or cumulative drops. The argument is set forth that the seed cells are filled to better advantage by this intermittent motion; the starting and stopping will shake the corn into the cells. To cause the seed cells to fill more perfectly, the kernels are prearranged by the corrugations and the slope of the seed-box bottom.

In the **continuous plate movement** the plates are driven from the main axle usually by a chain and sprockets. While the plates travel continuously, the size of the hill is determined by a valve movement which opens and closes the outlet from the seed plate. To produce this movement, two clutches with double cam attachments, one at each hopper, are used. At each trip of the planter the dog on the clutch is thrown out, and it turns through one-half revolution, allowing one cam to pass; at the same time the arm of the valve glides over the cam and opens the outlet to the hopper, which allows the corn to drop from

each cell until the cam passes and the arm drops, closing the valve. Thus the length of this cam determines the length of time the valve is open, thereby controlling the number of kernels in the hill. Several lengths of cams are furnished with each planter. It is claimed in opposition to the claim set forth for the intermittent movement that the cells are more apt to be filled, for they are in continuous motion and travel a greater distance under the corn.

**171. The clutch.**—In the early planters the plate was driven entirely by the check wire. With each button the plate

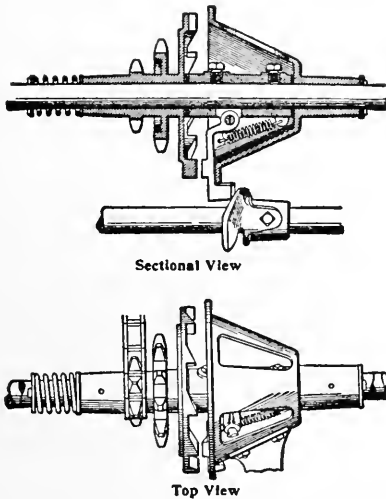

FIG. 92—THE SEED-SHAFT CLUTCH WHICH IS THROWN IN GEAR BY THE CHECK WIRE. THE POWER TO DRIVE THE SEED SHAFT THEN COMES FROM THE MAIN AXLE, NOT THE CHECK WIRE

was moved just far enough to deposit one hill in the seed tube. When the cumulative drop was developed, a means had to be provided to rotate the plate long enough to count out the hill. To arrange for this, the button was

made to throw a clutch which put the dropper shaft in connection with a chain drive from the main axle. This clutch remained in gear for one revolution of the shaft, which is equivalent to one-fourth revolution of the seed plate. The one-fourth of the seed plate was arranged with enough seed cells to count out one hill. This clutch may be made to operate a valve which will permit a suffi-

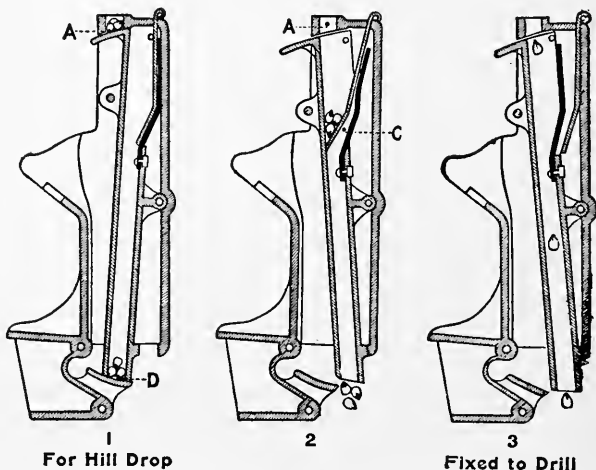

FIG. 93—A DOUBLE VALVE MECHANISM SHOWING HOW THE CORN IS RELEASED AT THE HEEL OF THE FURROW OPENER

cient number of kernels to leave the plate to make a hill as described above. The clutch has relieved the check wire of a large portion of its work. It is only required to put the clutch in gear and to open the valves in the shank. The clutch is one of the vital parts of the planter, and is often the first part to wear out and give trouble. Fig. 92 illustrates a planter clutch.

172. **Valves** are divided into two classes: single and double valves. The single valve is placed in the heel of

the furrow opener. The corn may be either caught here a single grain at a time or a full hill at a time. When the check wire throws the valve open to let a hill out, it closes in time to catch the next hill.

With the double valve, the hill is caught twice in its transit from the seed box to the ground. Fig. 93 shows one style of double-valve arrangement.

The lower valves are made quite close to the ground and arranged to discharge backward and downward

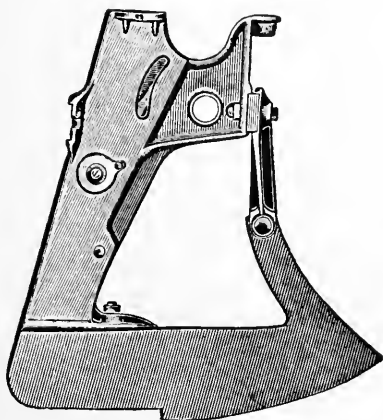

FIG. 94—THE STUB-RUNNER FURROW OPENER

into the furrow to overcome the tendency to carry the hill on and make uneven checking.

**173. Furrow openers.**—The **curved runner** is used on a large majority of planters as a furrow opener. It is easy to guide, but will not penetrate trash or hard soil as well as some others. The curved runner is illustrated in Fig. 89.

The **stub runner** has good penetration and will hook under trash and let it drag to one side out of the way.

There is less tendency for the stub runner to ride over trash than the curved runner. Fig. 94 shows a stub runner. The stub runner cannot be used in stony or stumpy land.

The **single-disk furrow opener** has good penetration and is desired in some localities for that reason. It is also better adapted to trashy ground, the disks cutting their way through. The disks may or may not reduce draft;

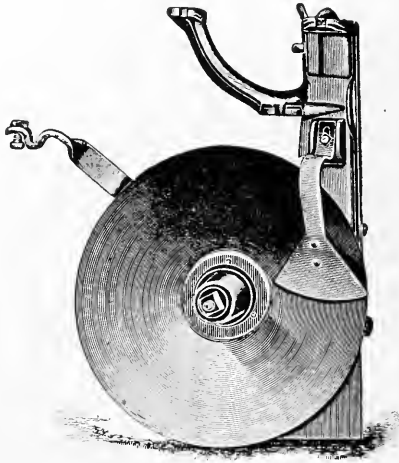

FIG. 95—THE SINGLE-DISK FURROW OPENER

at any rate, the planter is not a heavy-draft implement. Penetration is not often needed; more often the planter has a tendency to run too deep. The single-disk planter throws the soil out one way, and it is difficult for the wheels to cover the seed. The disk has a bearing to wear out, which the runner has not.

The **double disk** cuts through trash to good advantage, but does not have the penetration of the single disk. It

has two bearings to wear out to each furrow opener. It is claimed dry dirt falls in behind the disks on the corn, preventing early germination. All disk planters are very hard to guide. They do not follow the team well.

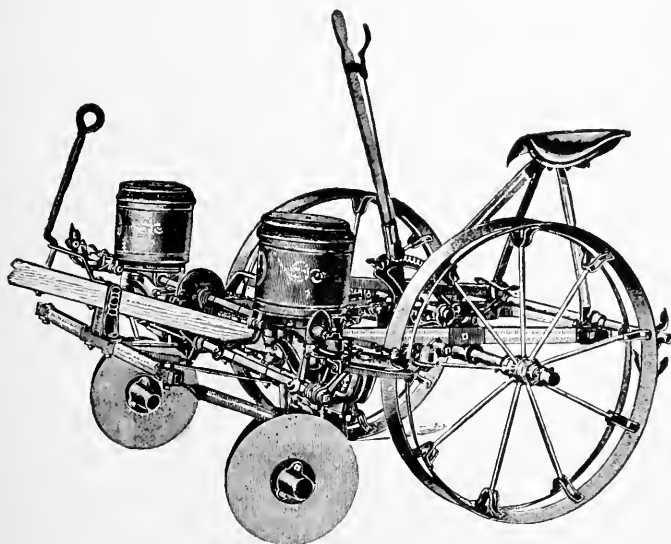

FIG. 96—A CORN PLANTER WITH DOUBLE-DISK FURROW OPENERS, OPEN WHEELS, AND HORIZONTAL CHECK HEADS

174. Planter wheels may be had in almost any height, from very low wheels to those high enough to straddle listed corn ridges. The tire may be flat, concave, or open (Fig. 97).

The flat wheel is not used to any extent on planters to-day, but is offered for sale by most manufacturers. It does not draw the soil well over the corn, but leaves this hard and smooth to bake in the sun, and gives the water a smooth course to follow after heavy rains.

The **concave wheel** gathers the soil better than the flat wheel, but leaves the surface smooth.

The **open wheel** is now used to a larger extent than any other type. It has the good gather, covering the corn

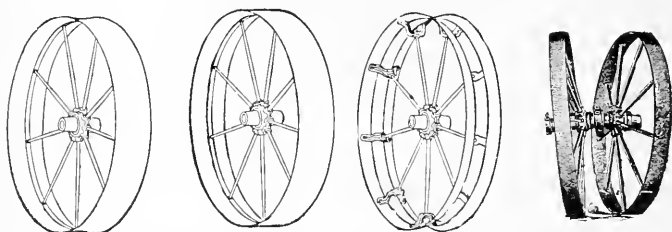

FIG. 97—CORN-PLANTER WHEELS WITH CONCAVE, FLAT, AND OPEN TIRE; ALSO THE DOUBLE WHEEL

well; the ground has no tendency to bake over the corn, and the water during rains is carried to one side of the track.

The **double wheel** consists in two wheels instead of one to cover the corn, and may be set with more or less gather, thus being able to cover the corn under all conditions.

**175. Fertilizer attachment.**—In some localities it is necessary to use fertilizer to secure an early and quick growth of corn. An attachment is made to drop fertilizer for each hill, and careful adjustment must be made to drop the fertilizer the right distance from the hill. If too far away, it will not give immediate benefits, and if placed too close, will rot the corn. This adjustment is difficult owing to the difference in speeds at which planters are operated.

**176. Marker.**—Markers are made in two styles, the **sliding** and the **disk**. The disk has proved to be a very satisfactory marker.



**177. Wire reel.**—Two types of check wire reels have been developed: one to reel by friction contact to the planter wheel, and one to reel under the seat with a chain to the main axle, using a friction clutch on the spool. It is claimed to be desirable to wind the wire on a solid, smooth drum rather than on a reel, as the former kinks the wire less.

**178. Conveniences.**—In making a purchase of a planter it is well to have in mind the conveniences which may be had, as well as the matter of strength, durability, and accuracy. Convenience in turning and reeling the wire is first to be considered. Another advantage offered by some planters over others is in the convenience of changing plates. It is very handy to have a seed box which may be tipped over and emptied without picking the seed out by hand.

The planter should have an adjustable tongue by which the front may be kept level. Unless the planter front is level, an accurate check cannot be obtained if the heel of the furrow opener is too far ahead or too far to the rear. It is impossible to get an even check if the planter front is not carried level.

It is desirable to have the check-roller arms act independently of each other, as it relieves the wire of some work. Two types of check heads for check rowers are used, the vertical and horizontal, but seem to be equally satisfactory.

**179. Draft of planters.**—Draft tests gave the following results for the mean draft of two styles of planters:

Planter with open wheels.....	212 pounds
Planter with double wheels.....	237 pounds

**180. Calibration of planters.**—It is an undisputed fact that high accuracy cannot be secured with any planter

unless the corn be of uniform size and a seed plate chosen to suit the size of corn. Types of corn vary much in size of kernel, and one plate will not suit all types and varieties. Makers usually furnish several plates with their machines, and others may be secured if necessary. It stands to reason that no planter can do good work unless these conditions are fulfilled. The planter should be calibrated and tested before taken to the field, if accuracy of work is desired.

**181. Corn drills.**—Although most planters may be set to drill corn, the corn drill remains a distinct tool and is

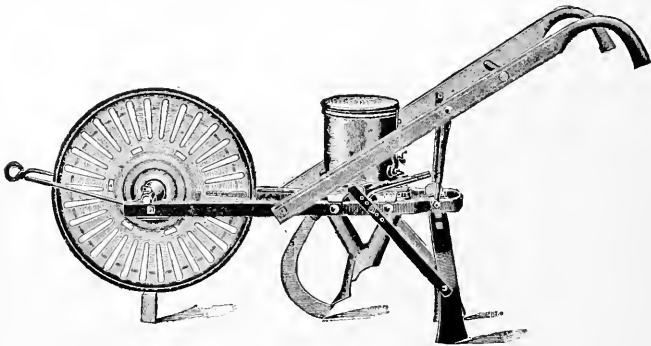

FIG. 98—THE SINGLE-ROW CORN DRILL

used to a large extent in certain localities of the country. Fig. 98 shows a single-row drill which differs but little from others except that an extra knife is provided in front of the seed tube. Various covering devices in the way of shovels and disks are provided. Drills are now made to take two rows, and even four, when made as an attachment to a grain drill.

**182. Listers.**—The use of the lister is confined to the semi-arid regions. It can be used in most of the corn-growing sections where the rainfall is not overabundant.

It is not adapted to fields that are extremely level, as water will collect in the ditches after rains and drown the corn while small. Neither can it be used in hilly localities, as the corn will in this case be washed out.

The lister is simply a double plow throwing a furrow both ways. The seedbed is prepared at the bottom of the furrow with a **subsoiler**. The planting may be done later or with an attached drill, which plants as the furrow is opened up. Thus plowing and planting are done at one operation. Fig. 99 shows one of the latest styles of walk-

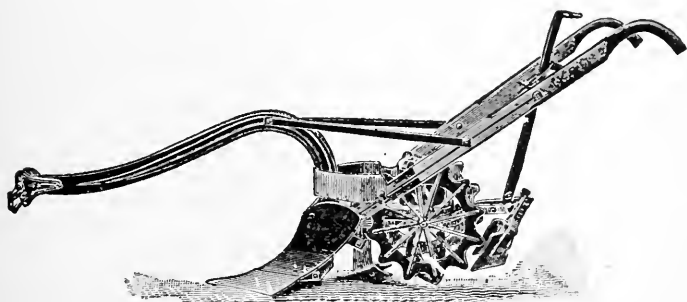

FIG. 99—A SINGLE-ROW WALKING LISTER WITH A CORN DRILL ATTACHED. DISKS ARE USED IN PLACE OF THE COVERING SHOVEL.

ing listers with sprocket-wheel-covering attachments. The drill attachment may be used independently as a drill. Fig. 100 is a representative three-wheel riding lister. Riding listers are also made without the furrow wheel, and when so made are termed sulky listers. Even the lister as a single-row machine has not been rapid enough for the Western farmer, and several makes of a two-row lister are to be found upon the market.

**183. Loose-ground listers.**—Listing of corn has some disadvantages. When listing is practiced, the soil is not all loosened, and when successive crops are grown in the same way an effect upon the yield is noticed. To gain the

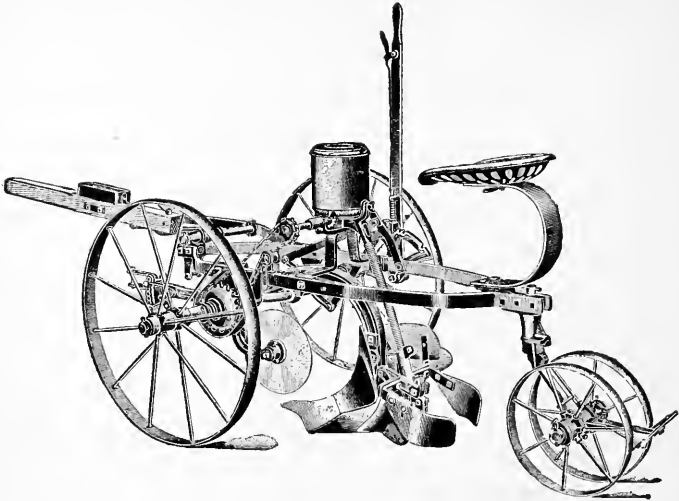

FIG. 100—A THREE-WHEELED RIDING LISTER AND DRILL

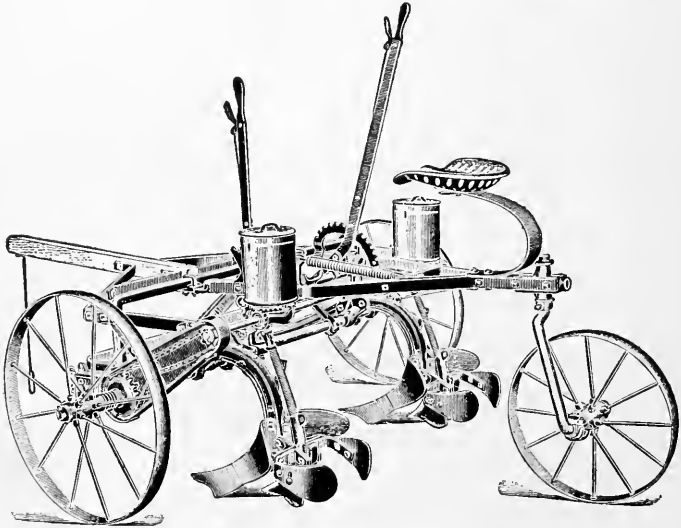

FIG. 101—A TWO-ROW LISTER

advantages of listing after plowing, the loose-ground lister has been developed. This tool is a two-row machine provided with disks to open the furrow, instead of right and left moldboards. Moldboards will not scour in loose ground, hence the use of disks. When the loose-ground lister is used, the ground must be plowed as for the planter, thus increasing the cost. The merits of the system consist in having the corn deeper to stand the drought better, and to be better braced to stand the high

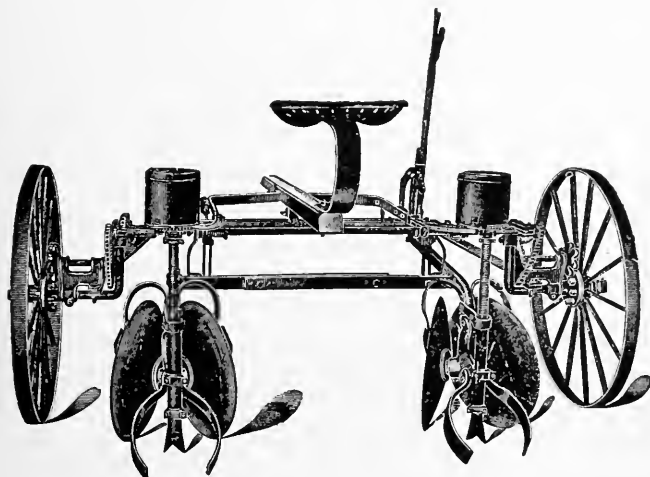

FIG. 102—A LOOSE-GROUND LISTER. DISK FURROW OPENERS MAY BE USED ON PLANTER FOR THE SAME PURPOSE

winds of the fall and not become "lodged." The fact that the corn is placed in a furrow makes it more easily tended because there is a large amount of soil to be moved toward the corn. In the moving of this dirt, any weeds are easily destroyed. Fig. 102 shows a loose-ground lister. Attachments are provided which may be placed upon corn planters to give the same results.

## CHAPTER VII

### HARVESTING MACHINERY

Agricultural machinery has done much for the agriculturist in enabling him to accomplish more in a given time, and to do it with less effort, than before its introduction. Although this is true of all agricultural machinery, it is especially true of harvesting machinery. By its use it has been estimated that the amount of labor required to produce a bushel of wheat has been reduced from 3 hours and 3 minutes to 10 minutes.

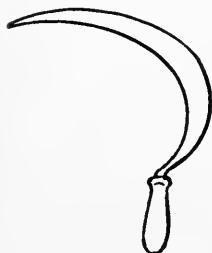

FIG. 103—THE SICKLE,  
AN EARLY HAND-  
REAPING TOOL

In this brief discussion harvesting machinery will be considered in its broadest sense and will include reapers, self-binders, headers, combined harvesters, and corn-harvesting machinery.

**184. Development of hand tools.**—From the oldest records that remain we find that the people of that early time were provided with crude hand tools for the reaping of grain. These primitive sickles, or reaping hooks, were made of flint and bronze, and are found among the remains left by the older nations. Upon the tombs at Thebes, in Egypt, are found pictures of slaves reaping. These pictures were made 1400 or 1500 B.C. The form of the Egyptian sickles varied somewhat, but consisted generally of a curved blade with a straight handle.

The scythe is a development from the sickle and differs from it in that the operator can use both hands instead of one. The Flemish people developed a tool known as the Hainault scythe. It has a wide blade 2 feet long, having a handle about 1 foot in

length. The handle is bent at the upper end and is provided with a leather loop, into which the forefinger is inserted to aid in keeping the tool horizontal. The grain was gathered by a hook in the left hand. This tool was displaced later by the cradle.

Development in scythes has consisted in making the blade lighter, lengthening the handle, and adding fingers to collect the grain and to carry it to the end of the stroke. With the addition of the fingers, the tool was given a new name, that of the **cradle scythe**, or the **cradle**. And it was in this tool that the first American development took place. The colonists, when they settled in this country, probably brought with them all of the European types, and the American cradle was simply an improvement over the old country tools. The time of the introduction of the cradle has been fixed by Professor Brewer, of Yale, in an article written for the Census Report of 1880, as somewhere between 1776 and the close of the eighteenth century.

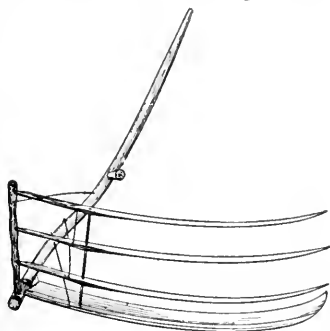

FIG. 104—THE AMERICAN CRADLE. THE TOOL USED FOR REAPING UNTIL AFTER THE MIDDLE OF THE NINETEENTH CENTURY

The American cradle stands at the head of all hand tools devised for the reaping of grain. When it was once perfected, its use spread to all countries, with very little change in form. It has been displaced, it is true, by the horse reaper almost entirely; yet there are places in this country and abroad where conditions are such that reaping machines are impracticable and where the cradle has still a work to do. Again, there are parts of the world where the reaping machine has never been introduced and where the sickle and the cradle are the only tools used for reaping. It seems almost incredible that any people should be so backward as to be using at the present time these primitive tools, yet it is to be remembered that even the most advanced nations used them for centuries, and apparently did not think of anything in the way of improvement.

**185. The first reaper.**—History records several early attempts toward the invention of a machine for harvesting, but none

reached a stage where they were practical until the eighteenth century. Pliny describes a machine used early in the first century which stripped the heads of grain from the stalk. The machine consisted of a box mounted upon two wheels, with teeth to engage the grain at the front end. It was pushed in front of an animal yoked behind it. The grain was raked into the box by the attendant as the machine was moved along. It is further stated that it was necessary to go over the same areas several times.

**186. English development.**—There were several attempts at the design of a reaping machine before 1806, but none were successful. They need not be considered in this discussion. It was in 1806 that Gladstone invented a machine which added many new ideas. In his machine the horse walked to the side of the grain, and hence the introduction of the side cut. It had a revolving cutter and a crude form of guard. It did, however, have a new idea in an inside and outside divider. The grain fell upon a platform and was cleared occasionally with a hand rake. As a whole, this machine was not successful.

In 1808 Mr. Salmon, of Woburn, invented the reciprocating cutter, which acted over a row of stationary blades. This machine combined reciprocating and advancing motion for the first time. The delivery of the grain was unique in the fact that a vertical rake actuated by a crank swept the grain from the platform upon which the grain fell after being cut.

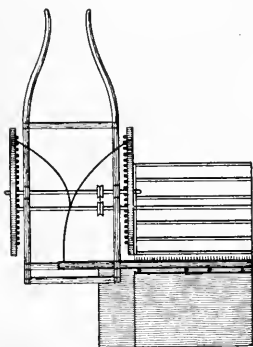

FIG. 105—OGLE'S REAPING MACHINE (ENGLAND, 1822)

In 1822, Henry Ogle, a schoolmaster of Remington, in connection with a mechanic by the name of Brown, designed and built a machine which is worthy of mention. The use of a reciprocating knife had been hinted at by Salmon, but Ogle made it a success. This machine also had the first reel used, and was provided with a dropper. Accounts are not specific, but it is thought that the operator for the first time rode upon a seat.

The next machine was the most successful up to that time (1826). Patrick Bell, a minister of Cannyville, Forfarshire, has



the honor of designing it. His machine had oscillating knives, each of which were about 15 inches long and about 4 inches broad at the back, where they were pivoted and worked over a similar set of knives underneath like so many pairs of shears. The rear ends of the movable blades were attached to an oscillating rod connected with a worm flange on a revolving shaft. It presented a new idea in having a canvas moving on rollers just behind the cutting mechanism, which carried the grain to one side and deposited it in a continuous swath. Bell also provided his machine with a reel and inside and outside dividers. His

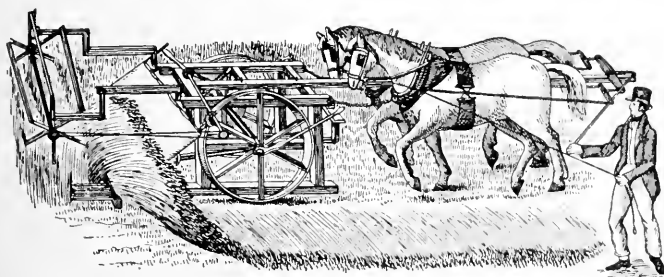

FIG. 106—BELL'S REAPING MACHINE (ENGLAND, 1828)

machine marks the point when the development of the reaping machine was practically turned over to Americans. It never was very practical because it was constructed upon wrong principles, but nevertheless it was used in England for several years until replaced with machines built after the inventions of the Americans, Hussey and McCormick.

**187. American development.**—Beginning with the year 1803, a few patents were recorded before Hussey's first patent, which was granted December 31, 1833. These were not of any importance, since they did not add any new developments and were not practical. The only one which gave much encouragement was the invention of William Manning, of New Jersey, patented in 1831. Manning's machine had a grain divider and a sickle which were similar to those used later in the Hussey and McCormick machines.

It was in 1833 when Obed Hussey, of Baltimore, Maryland, was granted his patent which marks the beginning of a period

of almost marvelous development. Though Cyrus B. McCormick was granted his first patent June 21, 1834, it is claimed that his machine was actually built and used before Hussey's, whose machine had the priority in the date of patents.

Hussey's first machine was indeed a very crude affair. It consisted of a frame carrying the gearing, with a wheel at each side and a platform at the rear. The cutter was attached to a pitman, which received its motion from a crank geared to the

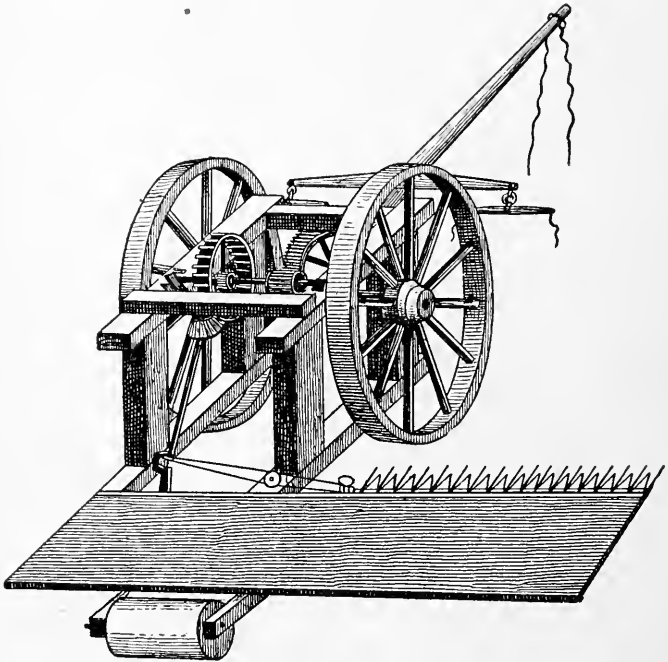

FIG. 107—HUSSEY'S REAPING MACHINE (AMERICA, 1833)

main axle. The cutter worked in a series of fingers or guards, and perhaps approached the modern device much closer than any reaper had up to this time.

McCormick's machine was provided with a reel and an outside divider. The knife had an edge like a sickle and worked through

wires which acted for the fingers or guards of Hussey's machine. The machine was of about  $4\frac{1}{2}$  feet cut and was drawn by one horse. The grain fell upon a platform and was raked to one side with a hand rake by a man walking.

Of the two machines, perhaps Hussey's had the more valuable improvement and it was nearer the device which proved to be successful later. Friends of both these men claim for them the honors for the first successful reaper. Hussey did not have the energy and the perseverance, and hence lost in the struggle for

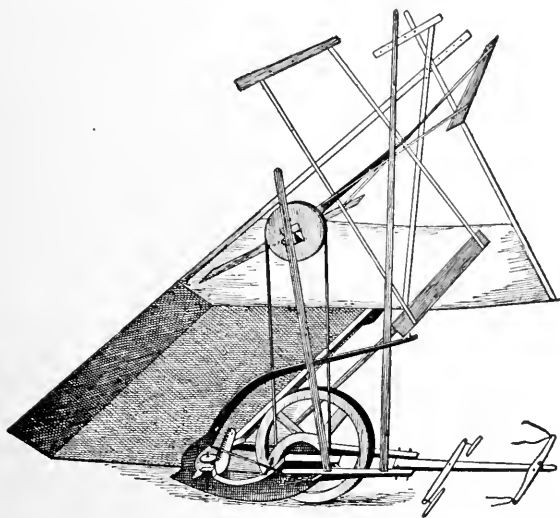

FIG. 108—M'CORMICK REAPING MACHINE (AMERICA, 1834)

supremacy which followed. At first the honors were evenly divided. In 1878 McCormick was elected a corresponding member of the French Academy of Sciences upon the ground of his "having done more for the cause of agriculture than any other living man."

Palmer and Williams, July 1, 1851, obtained a patent for a sweep rake which swept the platform at regular intervals, leaving the grain in bunches to be bound.

The next invention of importance was that of C. W. and

W. W. Marsh, of Illinois. A patent for this was granted August 17, 1858, and gave to the world the Marsh harvester. This carried two or more attendants, who received the grain from an elevator and bound it into sheaves. The two Marsh brothers, in connection with J. T. Hollister, organized a company which built 24 machines in 1864 and increased the output each year until in 1870 over 1,000 machines were built. This company was finally merged into the Deering Harvester Company.

George H. Spaulding invented and was granted a patent on the packer for the modern harvester, May 31, 1870. This invention was soon made use of by all manufacturers. John P. Appleby developed the packer and added a self-sizing device. He has also the honor of inventing the first successful twine knoter. The Appleby knoter, in a more or less modified form, is used on almost every machine to-day.

Jonathan Haines, of Illinois, patented, March 27, 1849, a machine for heading the grain and elevating it into wagons driven at the side of the machine.

In certain parts of the West, notably California, where conditions are such that grain will cure while standing in the field, a combined machine has been built which cuts, threshes, separates, and sacks the grain as it is drawn along either by horses or by a traction engine. The first combined machine was built in 1875 by D. C. Matteson. Benjamin Holt has done much to perfect the machine. The development of the grain harvester may be summarized as follows:

Gladstone was the first to have a side-cut machine.

Ogle added the reel and receiving platform.

Salmon gave the cutting mechanism, which was improved by Bell, Hussey, and McCormick.

To Rev. Patrick Bell must be given credit for the reel and side-delivery carrying device.

Obed Hussey gave that which is so important, the cutting apparatus.

For the automatic rake credit must be given to Palmer and Williams.

For a practical hand-binding machine the Marsh brothers should have the honor.

To Spaulding and Appleby the world is indebted for the sizing, packing, and tying mechanisms.

Jonathan Haines introduced the header.

Many other handy and important details have been added by a multitude of inventors, but all cannot be mentioned.

**188. The self-rake reaper.**—The modern self-rake resembles the early machine very much, and improvement has taken place only along the line of detail. The machine has a platform in the form of a quarter circle, to which the grain is reeled by the rakes, as well as removed to one side far enough to permit the machine to pass on the next round. The cutting mechanism is like that of the

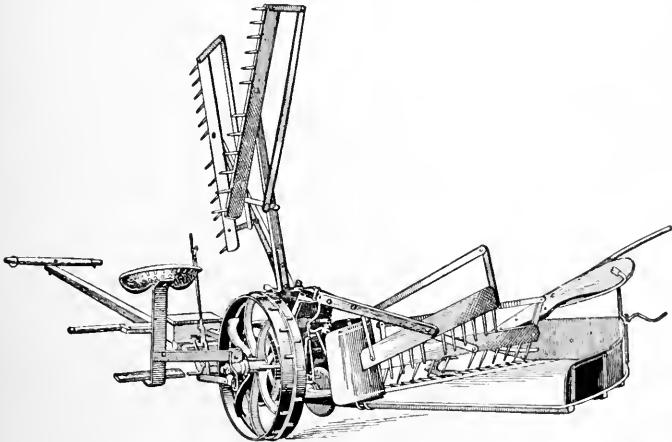

FIG. 109—A MODERN SELF-RAKE REAPER

harvester. The machine is used to only a limited extent owing to the fact that the grain must be bound by hand. The reaper is preferred by some in the harvesting of certain crops, like buckwheat and peas. It is usually made in a 5-foot cut, and can be drawn by two horses, cutting six to eight acres a day.

### MODERN HARVESTER OR BINDER

**189.** The modern self-binding harvester consists essentially of (1) a drive wheel in contact with the ground;

(2) gearing to distribute the power from the driver to the various parts; (3) the cutting mechanism of the serrated reciprocating knife, driven by a pitman from a

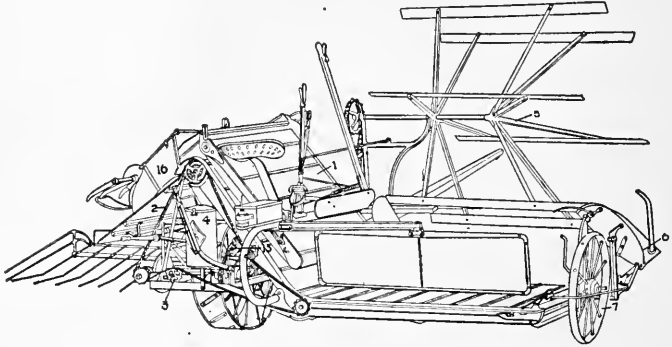

FIG. 110—A MODERN SELF-BINDING HARVESTER OR BINDER

crank, and guards or fingers to hold the grain while being cut; (4) a reel to gather the grain and cause it to fall in form on the platform; (5) an elevating system of endless

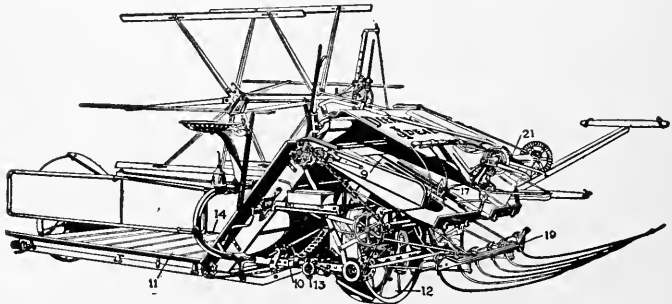

FIG. 111—ANOTHER MODERN HARVESTER

webs or canvases to carry the loose grain to the binder; and (6) a binder to form the loose grain into bundles and tie with twine.

Some of the more important features and individual parts will now be discussed in regard to construction and adjustment. Parts are numbered to correspond with numbers in Figs. 110 and 111.

**190. Canvases (1)** should be provided with tighteners by which they may be loosened when not in use. Tighteners also make it more convenient to put canvases on the machine. The elevator rollers should be driven from the top, thus placing the tight side next to the grain. The creeping of canvases is due to one of two things, either the canvases are not tight enough or the elevator frame is not square. If the elevator is not square, the slats will be torn from the canvases. This trouble may be overcome by measuring across the rollers diagonally or placing a carpenter's square in the corner between guide and roller, and adjusting. The method of adjustment varies with different makes, but the lower elevator is usually adjusted with a brace rod to the frame, and the upper elevator with a slot in the casting attaching the guide to the pipe frame.

**191. Elevator chains (2).**—Two kinds of chains are found in use, the steel chain and the malleable. The steel chain is claimed to be the most durable, but has the disadvantage of causing the sprocket teeth to cut away faster. This wear is often the greatest upon the driving sprocket, as it has the most work to do. It is thought that the steel chain is the most desirable chain to have.

**192. The chain tightener (3).**—The chain tightener may have a spring or slot adjustment. The spring adjustment is very handy and an even tension is maintained on the chain. The elevator chain should not be run with more tension than needed, as it produces wear and adds to the draft.

**193. Twine box (4).**—The location of the twine box is

the principal thing to be considered in order to secure the greatest convenience in watching the twine, and also in adding new balls.

**194. Reel (5).**—Convenience and strength are the principal things to be considered in a selection of a reel. It should have the greatest range of adjustment and permit this adjustment to be made easily. The making of a good bundle and the handling of lodged grain depend largely upon the manipulation of the reel. This may mean that the reel must be adjusted several times during a single round of a field.

The reel slats or fans should be adjusted to clear the dividers equally at each end, and also to travel parallel to the cutter bar.

**195. Grain dividers (6).**—It is an advantage to have the outside divider adjustable not only for different-sized grain, but also for making the machine narrow when mounted upon the transport trucks.

**196. Grain wheel (7).**—The weak point of the grain wheel is the bearing, and it is often necessary to replace the axle and boxings several times during the life of a machine. In order to prolong the life of the grain-wheel axle, it is made, by some manufacturers, with a roller bearing.

**197. Elevators (8).**—The elevator should extend well to the front of the platform in order that the grain may not be hindered in the least in starting upon its path up the elevator. The guides should be hollowed out slightly on the side next the grain, giving the canvases a chance to expand and not drag heavily upon the guides. It is also an advantage to have the lower end of the upper guide flexible in order that it may pass over extra large bunches of grain. The open elevator, permitting the handling of long grain, as rye, is now almost universally adopted.



The sprockets by which the elevator rollers are driven should always be in line. Adjustment may be made by sighting across their face.

**198. Deck (9).**—The steeper the deck, the better; but makers have made it rather flat in order to reduce the height of the machine. The deck should be well covered by the packers to prevent clogging.

**199. Main frame (10).**—Main frames are shipped either separate or fastened to the platform. In the latter case, if there is a joint, it is riveted and very seldom gives any trouble in becoming loose. In the first case, bolts must be used; but they do not give any trouble if care is used in assembling the binder.

**200. Platform (11).**—The platform is now universally provided with an iron bottom, which is more durable and smoother for the platform canvas to pass over. It is made of painted iron, and it might be improved if it should be made of galvanized iron, as it often rusts out before the machine is worn out.

**201. Main wheel (12).**—The main wheel is one of the parts which usually outwear the rest of the machine. The tendency is now to make the main wheel too small. The larger wheel is more desirable, as it carries the load better and is able to give a greater driving power. Main wheels have now attained a standard size of 34 and 36 inches in the side-cut machine. The steel wheel is now used almost universally, the wooden wheel and the wooden-rimmed wheel having gone out of use entirely. Three types of spokes are used: the hairpin, the spoke cast in the hub, and the spoke fastened to a flange of the hub with nuts. The main wheel shaft or axle should be provided with roller bearings, and also a convenient and sure method of oiling. The bolt in the lower part of the quadrant should always be in place. When the bolt is out

it is possible to run the machine up too far and let the main axle start into the quadrants crosswise.

**202. Main drive chain (13).**—Two common types of drive chains are to be found upon the market: the all-malleable link and the malleable link with the steel pin. The latter is perhaps the more desirable, but not so handy for replacing broken links. The main chain should not pass too close to the tire of the main wheel, or it will clog with mud badly.

**203. Cutter bar (14).**—Two kinds of cutter bars are found, the Z bar and the angle bar. One seems to be as good as the other, but some little difference is to be found between the angle given to the guards, enabling some machines to cut closer to the ground than others.

**204. Main drive shaft (15).**—The main drive shaft should be given good clearance from the main wheel to prevent clogging. This shaft is now generally provided with roller bearings, and often self-aligning bearings, which prevent any possible chance for the shaft to bind and thus increase the friction.

**205. Butter or adjuster (16).**—The canvas butter has always been very satisfactory, except it was short-lived. Often it was the first part of the binder to be replaced. This led several makers to build an adjuster which had oscillating parts or board. The single board seems to be just as satisfactory, as the upper half of the two-board adjuster does very little good. The all-steel belt as now commonly used upon push binders is no doubt the most satisfactory butter made. It is durable and efficient, but not generally adopted, probably on account of its cost.

**206. Packers (17).**—The packers should practically cover the deck, reaching within an inch or so of the deck roller. This will prevent any tendency to clog in heavy grain.

The third packer is considered an advantage, but is not generally adopted.

**207. Main gear (18).**—Considerable difference is to be noticed in different binders in the size of the gearing used. It is true that many makers are not liberal enough with material in the construction of the main gear wheels.

**208. Bundle carriers (19).**—Two general types of bundle carriers are to be found in use. In one the fingers swing back when depositing the load, while in the other the carrier is simply tipped down at the rear and the load of bundles allowed to slide off. The swinging bundle carrier scatters the bundles quite badly. While the other does not have this fault, it does not work so well in hilly countries, because in going downhill the bundles refuse to slide from the carrier, and in going uphill they will not stay on the carrier.

**209. Tension (20).**—The roller tension, introduced a few years ago, is without doubt the best device of the kind

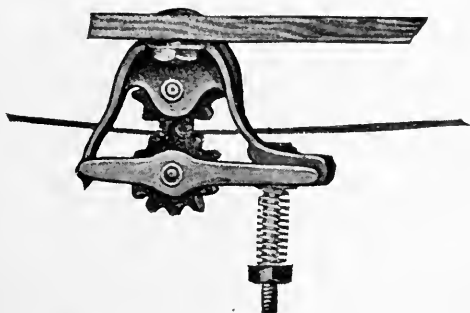

FIG. 112—A ROLLER TENSION FOR THE TWINE. A VERY SATISFACTORY DEVICE

yet invented. The twine will not be caught at knots, kinks will not be formed, and the tension is always even independent of the size of the twine.

The tension should not be used to produce tight bundles. It should be used only to keep the twine from playing out too fast.

**210. Binder attachment (21).**—The mechanism which ties the bundle is usually spoken of as the binder attachment. The first binder attachment depended upon a train of gear wheels to transmit the power to the needle and the knotter mechanism. At least one binder still retains this feature, while others have adopted the shaft and bevel gears, a chain and sprockets, or a lever in some form or other. Each binder, however, seems to be satisfactory in this particular. The levers have perhaps a disadvantage in that a very slight wear produces a marked effect upon the adjustment of the parts. The clutch is one of the important features of a binder attachment and perhaps demands of the expert more attention than any other one part of the binder. If the attachment stops before a bundle is made, even though it may be for but a short time, the action would indicate something to be wrong with the clutch. The binder attachment is driven directly from the crank shaft in some makes and in others by the elevator chain. The former method is to be preferred, as it relieves the elevator chain of part of its work.

**211. Knotter (22).**—The term knotter is applied to the knotter hook or the part on which the knot is produced, and also to the entire mechanism making the knot, including frame, knotter hook or bill, knotter pinion, knife, disk, gear, etc. (See Fig. 113.)

The knotter has been changed but little since it was first introduced by Appleby. The worm gears have to some extent been replaced by cam motion, which is more adjustable. Simplicity of parts may or may not be an advantage. An adjustable device to drive the twine disk, for instance, is often a great advantage. A stripper to

carry the twine from the knotter hook has proved more reliable than to depend upon the twine being pulled from the knotter hook by the bundle.

**212. Adjustment.**—It seems impossible to take up the adjustment of the binder in the light of experting in this treatise. However, there are a few misadjustments of

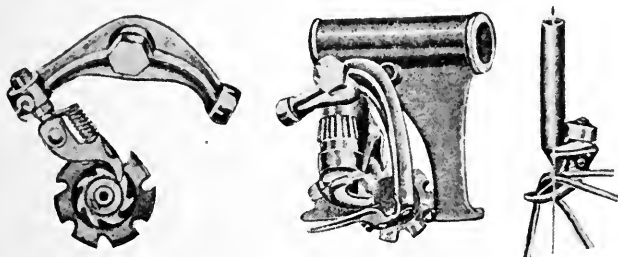

FIG. 113—A TWINE DISK. A KNOTTER COMPLETE—A KNOTTER HOOK

common occurrence, and often resulting in loss of dollars to the user of the machine, which may be taken up here.

1. A loose main drive chain permits the chain to ride the teeth of the sprocket and slip down the teeth, giving the machine a jerky motion, as if some part was catching and stopping the machine. A dry or muddy chain aids in giving this effect.

2. If the slats are torn from canvases, the elevators are not square or the rollers are not parallel to each other. The method of putting elevators in square has been explained.

3. If the main gear cuts badly and wears rapidly, either the gears do not mesh properly or the elevator chain is too tight.

4. The knotter hook will not work properly unless smooth and free from rust. It can be polished with fine emery paper.

5. The binder attachment will not do its work prop-

erly unless timed. By this is meant the adjustment of each part so it will do its share at the proper time. Marks are placed on the teeth of gear wheels and sprockets to enable them to be properly timed. Some binders are timed in as many as five places.

6. The knotter pinion must fit to the tyer wheel, and there must not be any lost motion. The tyer wheel, or cam wheel, may be set up against the knotter pinion, but if worn the knotter pinion must be replaced. If the knotter hook does not turn far enough to close the finger on the twine, a knot will not be tied.

7. If the cord holder does not hold twine tight enough, the twine will be pulled out before the knot is made. It should require a force of about 40 pounds to pull the twine from the disk. Adjustment is made with the cord-holder spring.

8. If the disk does not move far enough, the knotter hook will grasp only one cord; hence a loose band with a knot on one end.

9. If the needle does not carry the twine far enough, the hook will grasp only one cord, and hence a loose band with a loose knot. The travel of the needle is adjusted by the length of the pitman. The needle may become bent, as it is made of malleable iron, but it will permit of being hammered back into form.

10. If the knife is dull, it may pull the twine from the hook before the knot is made.

11. The compress spring relieves the strain on the machine when the needle compresses the bundle. It should never be screwed down until dead in an effort to make larger bundles.

12. The bundle-sizer spring—not the tension or compress spring—should be used to make tight bundles.

13. Good oil should be used and all holes kept open. In setting up new machines, kerosene should be used to loosen up the paint.

14. Any difficulty must be traced to its source, and adjustment should not be made haphazard in hope of finding the trouble.

**213. The transport truck.**—When it is necessary to move the binder from place to place, it is mounted upon transport trucks, which facilitate its transportation through gates and over bridges. The trucks are set under the machine by raising the machine to its maximum height and then lowering it to the trucks. The tongue is then removed and attached at the end of the platform beside or through the grain wheel. Some transports are more handy to attach than others.

**214. The tongue truck.**—Owing to the weight on the tongue and the fact that the team cannot be well placed directly in front of the machine to prevent side draft, the use of tongue trucks has become popular, especially on the wide-cut machine. Their use is to be commended, for not only is the work made easier for the horses, but it permits four horses to be hitched abreast.

**215. Width of cut.**—Binders vary in the width of cut or swath from 5 to 8 feet. The 6-foot machine is the common size to be used with three horses, the harvesting of 10 to 15 acres being an average day's work. The 7- and 8-foot machines are used in localities growing lighter crops and require four horses.

**216. Draft of binders.**—The following results were obtained during the season of 1906 at Iowa State College from testing a McCormick and a Deering binder cutting oats. The ground in both cases was dry and firm.

McCormick 6-foot: Average of three tests...	316 pounds
Deering 6-foot: " " "	...312 pounds

**217. The header** is a machine arranged to cut the standing grain very high, leaving practically all of the straw in the field. The cutting and reeling mechanisms of the header are much like those of the harvester, but the machine differs decidedly in the manner of hitching the teams for propelling it. It is pushed ahead of the horses and guided from the rear by a rudder wheel. The headed grain is carried by canvases up an elevator and deposited in a wagon with a large box drawn along beside the machine. The header usually cuts a wide swath from 14

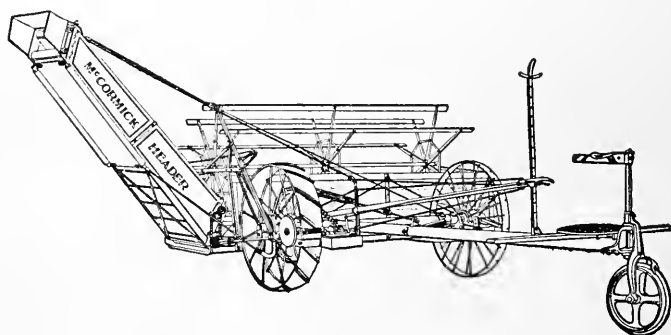

FIG. 114—THE MODERN HEADER

to 20 feet, and requires 4 to 6 horses to operate it. With it, 20 to 40 acres may be harvested in a day. An attachment is sometimes placed upon the header to bind the cut grain into bundles, in which case the grain is cut lower. This attachment must necessarily be very highly geared, but does very satisfactory work. A machine with a binder attachment is called a **header binder**.

**218. The combined harvester and thresher** is a threshing machine with a harvesting mechanism at the side which conveys the headed grain from a wide swath directly to the thresher cylinder. The cutting and elevating machinery is much like that of the header, and the



threshing machine is of the usual type. It is to be mentioned that this machine can be used only where the grain will cure while standing in the field, and where the climate provides a dry season for the harvest. These machines have an enormous capacity, harvesting and threshing up to 100 acres or to 2,500 bushels of grain a day. The swath varies from 18 to 40 feet. The power



FIG. 115—THE COMBINED HARVESTER AND THRESHER OPERATED BY STEAM POWER

may be furnished either by horses or a traction engine. From 24 to 36 horses or mules are required to furnish the power. All the horses or mules are under the control of a pair of leaders driven by lines. Following the leaders there are usually two sets of four, and the remainder of the animals are arranged in sets of six or eight. In this way one man is enabled to drive the entire team. At least three other men are required to operate the machine, one to have general supervision, one to tilt the cutter bar, and one to sew and dump the sacks when they accumulate in lots of six or eight. The largest machines are operated by steam power.

### CORN HARVESTING MACHINERY

219. **Development.**—The corn binder has become in recent years a very important tool because farmers have begun to realize the true worth of the cornstalk as feed for live stock.

It has been stated by good authorities that 40 per cent of the feeding value of the corn lies in the leaves and stalks. To let all this go to waste is, to say the least, poor economy, but to handle the corn crop entirely by hand is so laborious that it was not until modern labor-saving tools were developed that the saving of the entire crop could be practiced. It is true that the ear and the stalk have been used for stock food from the earliest time, but the practice was always limited in the corn belt as long as hand methods prevailed.

The earliest tool used for cutting corn was the common hoe, and certainly must have been a very awkward tool. Later the sickle was made use of in topping the corn, a method by which the stalk was cut off above the ear after fertilization had taken place. Methods used in an early time for the building of shocks or stooks of corn would seem very crude to-day. Often a center pole was sunk into the ground and horizontal arms inserted in holes in it. Against this the corn was piled until a shock of sufficient size was formed, then the arms were withdrawn, finally the center pole. The whole was compressed and tied with a cornstalk band. Another method used to-day is to tie the tops of four hills, forming a saddle against which the corn is piled.

The corn knife was soon developed, and was first perhaps an old scythe blade provided with a handle. The manufactured corn knife can now be bought in a variety of shapes and with a choice of handles. One style of knife may be fastened to the boot, but does not seem to be very successful.

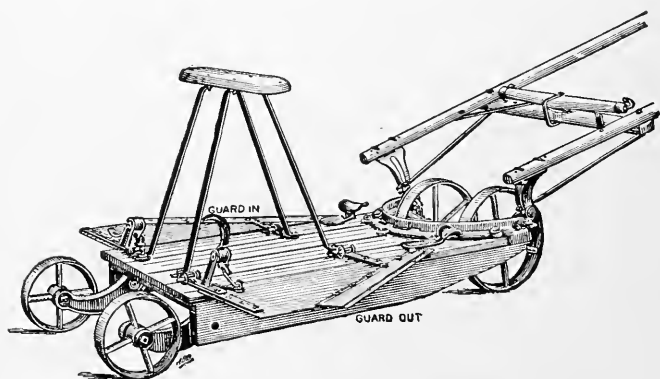

FIG. 116—A SLED CORN HARVESTER

D. M. Osborn & Co., as early as 1890, presented a corn harvester to the public. It cut the standing corn and elevated it into a wagon drawn beside the machine. The McCormick corn binder was soon to follow. It is a striking fact that the first McCormick machine was a machine pushed before the horses. In 1893 the Deering corn harvester was given a field

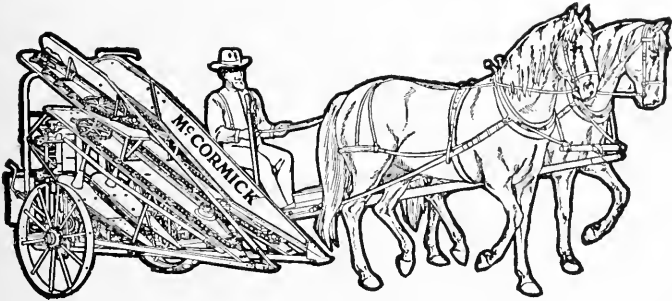

FIG. 117—THE VERTICAL CORN HARVESTER

trial, which was claimed to be very successful. To-day there are several corn harvesters upon the market.

220. **Sled harvesters.**—Many attempts were made following the introduction of the grain binder to build a corn harvester, but all resulted in failures. The sled harvester

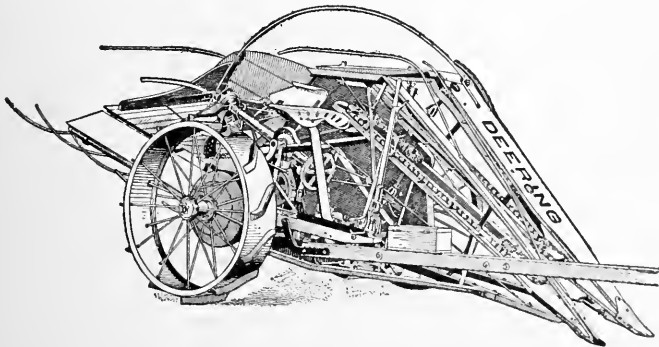

FIG. 118—THE HORIZONTAL CORN HARVESTER

was the first successful machine. It consists of a sled platform or a platform mounted upon small wheels, which carries knives at an angle to cut the corn as it is grasped by the operator, who rides on the platform. The machine is made for one horse, with the knives sloping back from the center, or for two horses, with the knives sloping from the outside to the center. This machine is cheap and has a much larger capacity than hand cutting. Heavy corn cannot well be handled, however, with a sled harvester.

**221. Types of harvesters.**—Corn harvesters may be divided into three classes, depending upon the position of the bundle while being bound. This may be either in a vertical, inclined, or a horizontal position (Figs. 117 and 118).

The vertical harvester seems to be the most popular, although the other types do very satisfactory work. Owing to the difference in the height of corn in various parts of the country, some makers provide two styles of harvesters, one for short corn and the other for tall.

The binder of the corn harvester resembles very closely the binder of the grain harvester. At first they were identical, but later it was found best to make the binder for the corn harvester a little heavier. The corn harvester should be provided with roller bearings and other conveniences of adjustment to be found upon the grain binder.

**222. The stubble-cutter attachment** consists of a knife attached to the corn harvester. It cuts the stubble close to the ground and makes further operations in the field more convenient. The attachment does not add much to the draft of the machine, and is surely a very useful device.

**223. The corn shocker** was one of the first machines

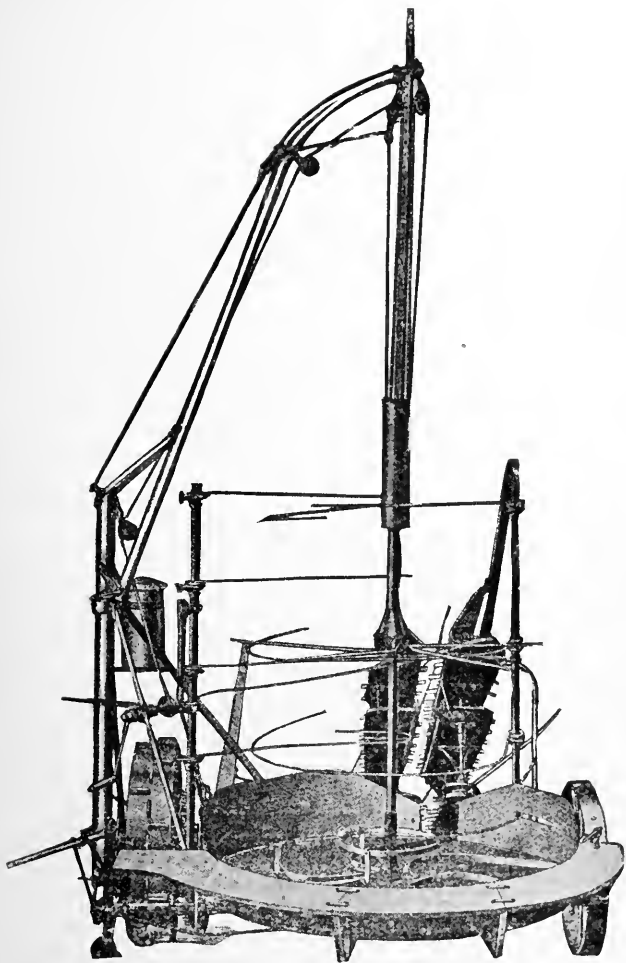

FIG. 119—A CORN SHOCKER. THE CORN SHOCK IS COLLECTED ON THE PLATFORM AND LIFTED TO THE GROUND AFTER BEING TIED

devised by the early inventors for the handling of the corn crop, but it was not presented to the public until after the introduction of the corn harvester or binder. It resembles the corn harvester in the construction of the dividers and the cutting mechanism. Fig. 119 illustrates the modern corn shocker. To the rear of the dividers a rotating table is placed with a center post. The corn is guided by fingers and angle irons to the center of the table. As additional stalks are cut they are added to the outside until a shock of proper size is formed. The machine is stopped and the shock tied with twine. By the aid of a windlass and crane the shock is lifted bodily from the table and dropped to the ground. When the tension on the lifting rope is slacked the arms which enabled the shock to be lifted are released by pawls, so they no longer remain in a horizontal position, but turn down as the center post is drawn from the shock.

The capacity of the corn shocker is only about one-half that of the corn harvester. It has the disadvantage that only small shocks can be made, which do not stand well and blow down easily. Another objection to its use is that the corn is more difficult to handle than when bound into bundles. There is, however, a saving of twine, and the work involved is not so laborious as that of shocking corn bundles by hand.

**224. Loading devices.**—The past few years have witnessed the introduction of several devices for loading corn fodder, hay, manure, etc. The machine usually consists of a crane or derrick with a horse lift by which a fork large enough to handle an entire shock is brought into action.

**225. Corn pickers.**—There have been many attempts to make a corn picker which would pick the ears from the standing stalk. For many years these attempts resulted

in failures. However, the present scarcity of farm labor and the liberal prices paid for the picking of corn have again encouraged many inventors to spend time and money upon a machine of this kind. During the recent seasons several makes of corn pickers have been tried, with more or less success. Without any doubt, it is only a question of time until a practical machine may be had.

Two general types of corn pickers are to be found: the corn picker proper and the corn picker-husker. The former does not attempt to husk the ears, but simply to remove the ears from the stalk. However, in this opera-

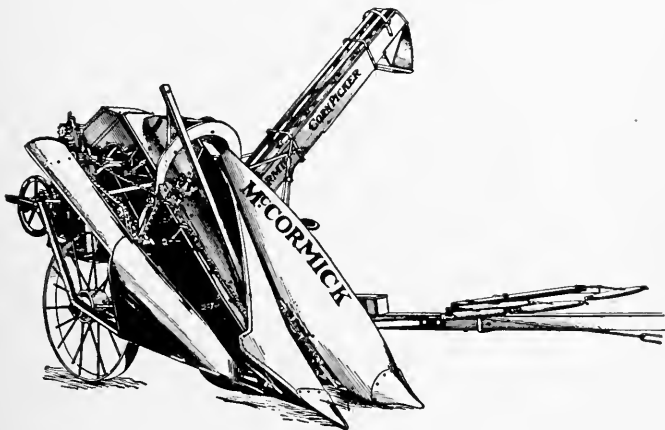

FIG. 120—THE CORN PICKER-HUSKER

tion a large portion of the husks are removed from the ear. The remaining husks do not greatly interfere with the feeding or shelling of the corn.

The other type is provided with husking rolls, which remove the husks before the ears are elevated into a wagon drawn beside the machine.

## CHAPTER VIII

### HAYING MACHINERY

The introduction of modern haying machinery has wrought almost the same change in the harvesting of the hay crop as harvesting machinery has in the harvesting of the small-grain crop. The labor involved under present conditions in the cutting, curing, and storing of a ton of hay is but a small fraction of what it was under the old system of hand methods.

The hay crop ranks third in value among our crops. The addition of several new plants has greatly increased the value of the hay crop. This is especially true of alfalfa and brome grass, which have proved to be very valuable hay crops. The practice of curing grass for forage was in vogue before written history was begun. The first tools were as crude as possible. To-day we have a very complete line of hay tools for all conditions of work.

### THE MOWER

226. **The mower.**—The development of the mower has been traced by M. F. Miller in the "Evolution of Harvesting Machinery,"\* a bulletin published by the United States Department of Agriculture, and we are pleased to quote as follows:

"In the early development of the mower it was so intimately connected with the reaper that a little space should here be devoted to a short review of its history. Hussey's first machine was really a mower, and it was upon this principle that the mower was afterward built. Many of the early machines con-

\* Bulletin No. 103, Office of Experiment Stations.



tained combinations of the mower and the reaper, and were used with a little adjustment to cut either grain or grass. A name that stands out prominently in the development of mowers is that of William F. Ketchum, who has sometimes been spoken

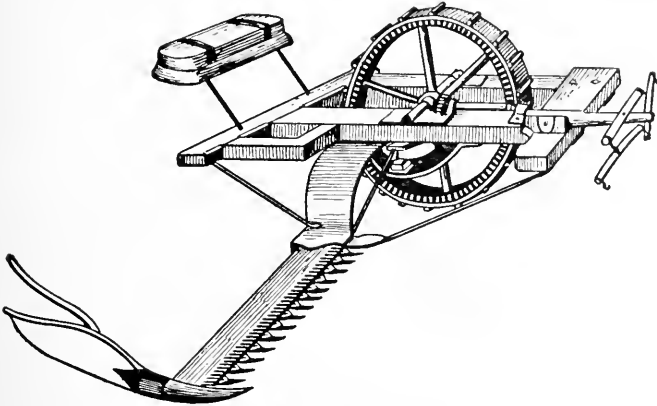

FIG. 121—KETCHUM'S MOWER (AMERICA, 1847)

of as the father of the mower trade, since he was the first to put mowers on the market as a type of machine distinct from the reaper. He took out several patents, but the one granted July 10, 1847, was of especial importance. The main features of this patent were the unobstructed space left between the driving wheel and the finger bar, with its support, and the remarkable simplicity of the machine. The cutter was an endless chain of knives, which never became successful, but which caused some excitement at the time. Ketchum afterward adopted the Hussey type of cutter and produced a very successful mower of the rigid-bar type. It was this machine that led the way in mower development and became the first really practical machine. . . .

"The first invention showing the feature of a flexible bar was that of Hazard Knowles, the machinist of the Patent Office at Washington. It showed many valuable features of a reaping machine also, but no patent was taken out. The patent granted to Cyrenus Wheeler, December 5, 1854, marks the division between the two types of machines. Wheeler was a practical man, and, like McCormick in the development of the reaper, suc-

ceeded in combining so many important features in his machines as to give him a place as one of the foremost pioneers in the development of the mower. The machine of 1854 was not a success as constructed, but the features of two drive wheels and a cutter bar jointed to the main wheels were lasting. . . .

"On July 17, 1856, a patent was granted to Cornelius Aultman and Lewis Miller containing principles that still exist in all successful mowers. The first patent claimed 'connecting the cutter bar to the machine by the double-rule joint or the double-jointed coupling pin.' It was reissued to cover an arrangement for holding up the bar while moving, and the combination of ratchet-wheel pawl and spring. On May 4, 1858, Lewis Miller took out a patent on a mower that combined the features of the former machine with some new principles. It contained all the elements of the successful modern two-wheeled machine, and mower development since that time has been a perfecting of this type. This machine was built under the name of the 'Buckeye,' and, with a substitution of metal for certain wooden parts, and certain other improvements, it is in use to-day. E. Ball, associated with this firm, also made valuable improvements in mowers. In 1856 a patent was granted to A. Kirby covering improvements made by him a few years previous, and his machines soon became popular. Others took up the manufacture of mowers at this early date, so that by 1860 the mower had become a thoroughly practical machine, and was being improved by various firms throughout the country. This improvement has gone on with the many makes of machines now in existence, and to-day we have various forms, from the single one-horse machine to the large two-horse type, with its long cutter bar, running with as light a draft as the former clumsy machine did with a cut but half as wide. As a result of this development the amount of hay produced in the United States has increased enormously, and to-day it stands as one of the most important crops."

### MODERN MOWERS

**227. Types.**—Modern mowing machines are of two types, the side-cut mower and the direct-cut mower. The cutter bar of the former is placed at one side of the drive

wheels or truck, while in the latter it is placed directly in front of the drivers. The mower consists essentially in (1) the cutting mechanism, comprising a reciprocating knife or sickle operated through guards or fingers and driven by a pitman from a crank, (2) driver wheels in contact with the ground, (3) gearing to give the crank proper speed, and (4) dividers to divide the cut grass from the standing.

228. The one-horse mower is usually a smaller size of the two-horse machine, fitted with shafts or thills instead of a tongue. It is made in sizes of  $3\frac{1}{2}$ - or 4-foot cut, and is used principally in the mowing of lawns, parks, etc.

229. The two-horse mower is commonly made in  $4\frac{1}{2}$ - and 5-foot cuts, although 6-, 7-, and 8-foot machines are

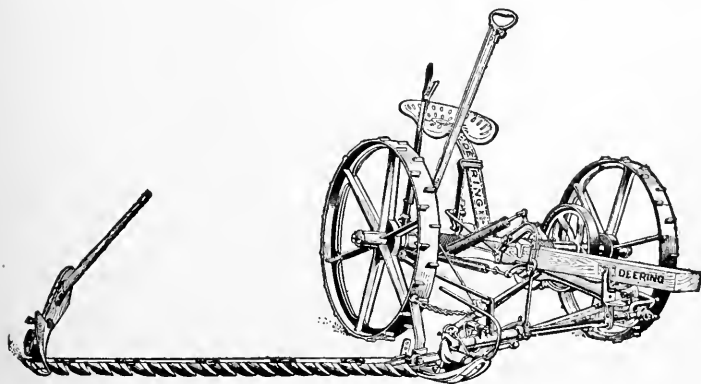

FIG. 122—A MODERN TWO-HORSE MOWER

manufactured. The latter are spoken of as wide-cut mowers and are usually of heavier construction than the standard machines (Fig. 122). From 8 to 15 acres is an average day's work with the 5- or 6-foot machines.

230. Mower frame.—Mower frames are usually made in one piece of cast iron. The openings for the axle and

the shafting are cored out, but where the bearings are to be located enough extra material is provided for boring out to size. Roller bearings are usually provided for the main axle.

**231. The crank shaft** is usually provided with a plain bearing at the crank and a roller bearing at the pinion end. A ball bearing is provided at the end of the small bevel pinion to take the end thrust. It is not possible to use a ball or roller bearing at the crank end, due to the vibratory action of the shaft tending to wear the bearing out of round. This bearing is either provided with an adjustment or an interchangeable brass bushing to take up the wear. The crank should be well protected from the front and under sides. The crank and pitman motion seems to be the most satisfactory device to transmit a reciprocating motion to the knife. A wobble gear was tried a few years ago, but has been given up. A mower is manufactured with a pitman taking the motion from the face of the crank wheel instead of the side. It is not known how successful this machine is.

**232. Main gears.**—The driving gears should be liberal in size and always closed in such a way as to be protected from dust, and also to facilitate oiling. It might be an advantage in mowers as in some other machines to have the gears run in oil.

**233. Wheels** should be high and have a good width of tire. The common height is 32 inches, and  $3\frac{1}{2}$  and 4 inches the common width of tire. It is some advantage to have several pawls to engage the ratchet teeth in the wheels, because this feature, in connection with a clutch with several teeth for throwing the machine in and out of gear, will make the machine more positive in its action. That is, the sickle will start to move very shortly after the main wheels are set in motion. Mowers driven by

large gear wheels in the drive wheels are more positive in their action and hence are preferred in foreign countries where very heavy swaths are to be cut.

**234. The pitman** in the mower corresponds to the connecting rod in an engine. Its function is to change circular motion into rectilinear motion, the reverse of the connecting rod. The crank pin and sickle should always be at right angles with each other, but this feature is not so essential when the pitman is connected to the sickle with a ball-and-socket joint.

Pitmans are made of wood and steel. Wood rods are the most reliable, because steel, due to the excessive vibration, becomes crystallized and weak. The steel pitman, however, may be so constructed as to be adjustable, and enables the operator to adjust the length until the knife acts equally over the guards at each end of the stroke. The pitman should be protected from being struck by any obstruction from the front.

**235. The cutter bar** is the cutting mechanism, exclusive of the sickle. It has a hinge coupling at one end and a divider and grass board at the other. The bar proper to which the guards are bolted should be stiff enough to prevent sagging. It is the practice in some machines to make the bar bowed down slightly and to straighten it by carrying the greater part of the weight at the hinge end, the weight of the bar itself causing it to straighten.

Some arrangement should be provided to take up the wear of the pins of the hinge joints in order that the cutter bar may be kept in line with the pitman.

**236. Wearing plates.**—Best mowers are now equipped with wearing plates where the sickle comes in contact with the cutter bar. They may be renewed at a small cost. The clips to hold the sickle in place are now made of malleable iron and are bolted in place to facilitate

their replacement when worn. If slightly worn, they may be hammered down until the proper amount of play between the clip and the sickle is obtained. Under normal conditions, this is about 1/100 of an inch. In no case should it be so open as to permit grass to wedge under the clips, but at all times should hold the knife well upon the ledger plates so as to give the proper shearing action.

**237. Mower guards** are fitted with two kinds of ledger plates, one with a smooth edge and the other with a serrated edge. The serrated plate holds fine grasses to better advantage than the smooth ledger plate, and in this way aids with the cutting.

**238. Shoes.**—The cutter bar should be provided with an adjustable shoe at each end, by means of which the height of cut may be varied to some extent. A weed attachment is often provided which will enable the cutter bar to be raised 10 inches or more. A shoe is better than a small wheel at the outer end of the bar because the wheel will drop into small holes, while the runner will bridge them.

**239. The grass board.**—The purpose of the grass board and the grass stick is to rake the grass away from the edge of the swath to give a clean place for the inside shoe the next round. The grass board should be provided with a spring to make it more flexible and less apt to be broken in backing and turning.

**240. Foot lifts.**—Nearly all modern mowers are now provided with a foot lift, which enables the operator to lift the cutter bar over obstructions, and also makes easier work for the team by lifting the bar while turning. A spring is necessary to aid in the lifting.

Certain mowers, known as vertical lift mowers, permit the cutter bar to be lifted to a vertical position by a lever, to pass obstructions, and at the same time the mower is

automatically thrown out of gear. When the bar is lowered the mower is again put in gear.

**241. Draft connections.**—The hitch on mowers is usually made low and below the tongue. A direct connection is sometimes made to the drag bar with a draft rod. This is styled a draw cut, and may have some advantage in applying the power more directly to the point where it is used.

**242. Troubles with mowers.**—If a mower fails to cut the grass and leave a clean stubble, there may be several things wrong: (1) the knife or sickle may be dull; (2) it may not fit well over the ledger plates, losing the advantages of a shear cut; (3) the knife may not register, or, in other words, it travels too far in one direction and not far enough in the other. The first of these troubles may be remedied by grinding, the second by adjusting the clips on top of the knife. There should be but a very slight clearance under these clips, and the exact amount has been given as 1/100 inch. To make the knife register in some makes, the pitman must be adjusted, while in others the yoke must be adjusted. If the mower leaves a narrow strip of grass uncut, it indicates that one of the guards has been bent down, a common thing to happen to mowers used in stony fields. Mower guards are now universally made of malleable iron and may be hammered into line with a few sharp blows with a hammer. The guards may be lined up by raising the cutter bar and sighting over the ledger plates and along the points of the guards.

**243. A windrowing attachment** consists in a set of curved fingers attached to the rear of the cutter bar, which rolls the swath into a windrow. It is useful in cutting clover, peas, and buckwheat. The attachment may be used as a buncher with the addition of fingers to hold the swath until tripped.

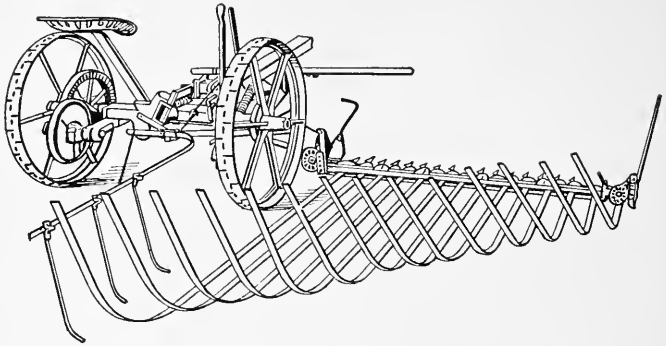

FIG. 123—A WINDROWING ATTACHMENT FOR A MOWER. IT MAY ALSO BE USED AS A BUNCHER

244. Knife grinder.—The knife grinder is a handy tool which may be attached to a mower wheel or to a bench.

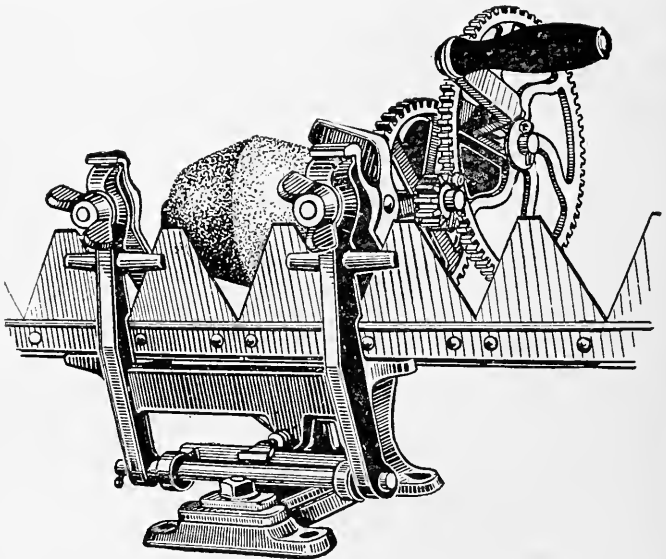

FIG. 124—A SICKLE OR MOWER KNIFE GRINDER



It is used for sharpening the mower knives. Usually it has a double-beveled emery wheel which will grind two sections of the knife at the same time. The emery wheel is given a high rotative speed by means of gearing or sprocket wheels and chain (Fig. 124).

## RAKES

**245. Development.**—The introduction of the mower created a demand for something better and with a greater capacity than the ordinary hand rake. As long as hand methods prevailed in the cutting of the grasses there was little need for anything better than the hand rake. The first horse rake was revolving. It did very satisfactory work when carefully handled. But later in the steel tooth rake there was found a much better tool. To Walter A. Wood Company, of Hoosick Falls, New York, is given the credit for bringing out the first spring-tooth rake. Differing from the modern tool, it was made almost entirely of wood except the teeth. The early rakes were dumped entirely by hand, but later an internal ratchet was provided on the wheels, which engaged a latch operated by the foot, and which carried the rake teeth up and over, thus dumping the load. The early rakes were almost universally provided with thills.

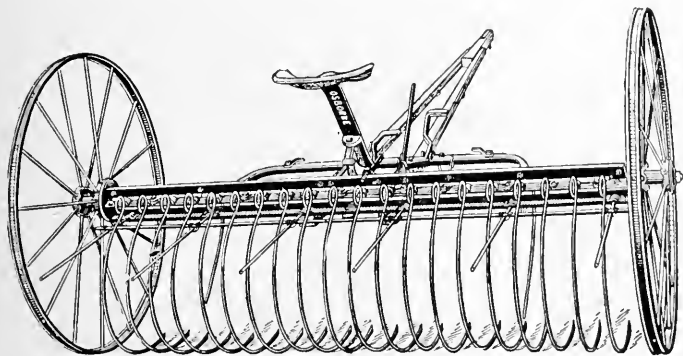

FIG. 125—A STEEL SELF-DUMP RAKE FOR TWO HORSES. THE TONGUE MAY BE SEPARATED INTO THILLS FOR ONE HORSE. THE TEETH HAVE ONE COIL AND CHISEL POINTS

Finally arrangements were made whereby the thills could be brought together and a tongue made for the use of a team instead of one horse.

**246. The steel dump rake or sulky rake.**—Although the first rakes were made of wood, there are now upon the market rakes made almost entirely of steel. The rake head to which the teeth are fastened is usually made of a heavy channel bar with a minimum of holes punched through it so as not to impair its strength.

In the selection of a rake considerable variance is offered in the choice of teeth, which may be constructed of  $7/16$ -inch or  $1/2$ -inch round steel, may have one or two coils at the top, be spaced  $3\frac{1}{2}$  inches to 5 inches apart, and have either pencil or flat points. The choice depends somewhat upon the kind of hay to be raked.

The rake is always provided with a set of cleaner teeth to prevent the hay from being carried up with the teeth when the rake is dumped. The outside teeth are sometimes provided with a projection which prevents the hay from being rolled into a rope and scattered out at the ends when the hay is very light. Sometimes an extra pair of short teeth is provided to prevent this rolling.

**247. Self-dump rakes** are always provided with a lever for hand dumping. Rakes are made from 8 to 12 feet in width. In the purchase of a rake the important things to look for are ease in operation, strength of rake head and wheels. Often the wheels are the first to give way. Some wheels are very bad about causing the hay to wrap about the hub. The wheel boxes should be interchangeable so they may be replaced when worn.

**248. Side-delivery rakes.**—The side-delivery rake was brought about by the introduction of the hay loader, the loader creating a demand for a machine which would

place the hay in a light windrow. The first of these machines was manufactured by Chambers, Bering, Quinlan Company, of Decatur, Illinois.

249. **One-way rakes.**—Practically all of these machines consist of a cylinder mounted obliquely to the front. They carry flexible steel-wire fingers, which revolve under and to the front. These fingers roll the hay ahead, and also

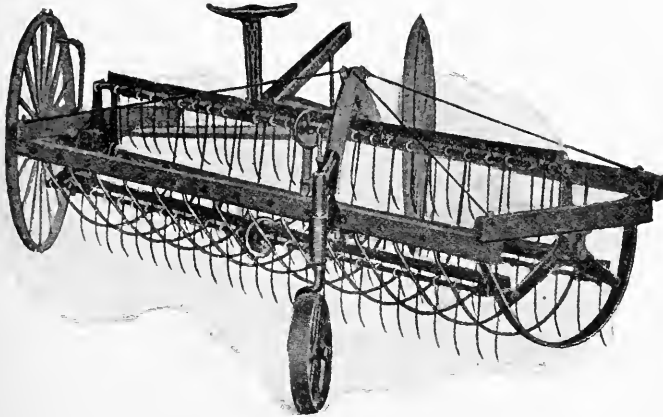

FIG. 126—ONE-WAY SIDE-DELIVERY RAKE

to one side. Some variance is to be found in the methods employed to drive the cylinder. Both gears and chain-and-sprocket drives are used.

250. **Endless apron, reversible rakes.**—There are other machines upon the market with a carrier or endless apron upon which the hay is elevated by a revolving cylinder and carried to either side. This machine does very satisfactory work and will place in one windrow as many as six swaths of the mower. By manipulation of the clutch driving the apron, this machine may be made to deposit the hay in bunches to be placed in hay cocks or loaded to a wagon by a fork.

The side-delivery rake takes the place of the hay tedder

to a large extent. The method of curing hay, especially clover, by raking into light windrows shortly after being mown, has proved very successful. A first-class quality of hay is obtained and in an equal length of time. It is claimed that if the leaves are prevented from drying up, they will aid very greatly in carrying off the moisture from the stems. Green clover contains about 85 per cent of water. When cured, only about 25 per cent is left. The leaves draw this moisture from the stems, and if free circulation of air is obtained the hay will dry quicker than if this outlet of the moisture for the water was cut

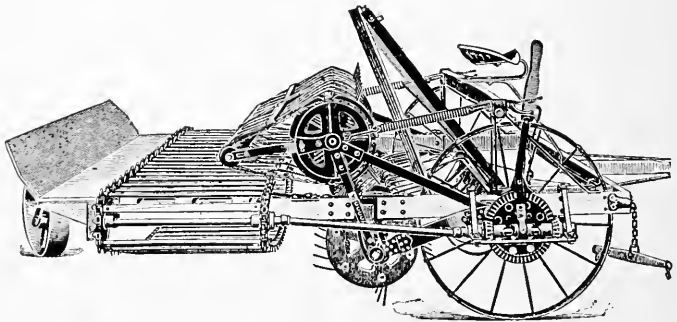

FIG. 127—THE ENDLESS APRON OR REVERSIBLE SIDE-DELIVERY RAKE

off by letting the leaves dry up. Many of the one-way side-delivery rakes may be converted into tedders by reversing the forks and the direction of their movement. The standard width for side-delivery rakes is eight feet. They are drawn by two horses.

### HAY TEDDERS

**251. Hay tedders.**—Where a heavy swath of hay is obtained, some difficulty is experienced in getting the hay thoroughly cured without stirring. To do this stirring the hay tedder has been devised. Grasses, when cut with

a mower, are deposited very smoothly, and the swath is packed somewhat to the stubble by the passing of the team and mower over it. The office of the tedder

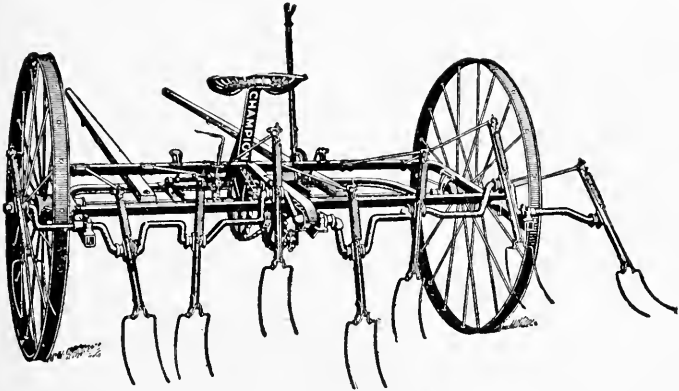

FIG. 128—AN EIGHT-FORK HAY TEDDER

is to reverse the surface and to leave the swath in such a loose condition that the air may have free access and thus aid in the curing.

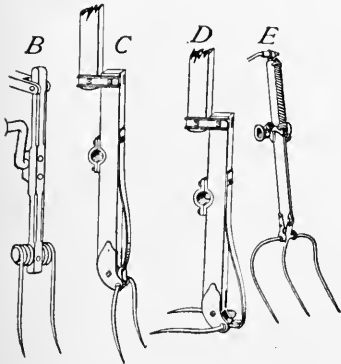

FIG. 129—TYPES OF TEDDER FORKS WITH COIL AND FLAT RELIEF SPRINGS. *D* SHOWS THE SPRING OF *C* SPRUNG

The hay tedder consists of a number of arms with wire tines or fingers at the lower ends. These are fastened to a revolving crank near the middle and to a lever at the other end. The motion of the cranks causes the tines to kick backward under the machine, thus engaging the mown hay, tossing it up and leaving it in a very loose condition. The modern machine, made

almost entirely of steel, is illustrated in Fig. 128. The size of tedders is rated by the number of forks. Tedders constructed of wood are still upon the market. The fork shaft may be driven by a chain or by gearing.

### HAY LOADER

252. **Development.**—The hay loader has been upon the market for some time, but only during recent years has there been any great demand for the tool. The Keystone Manufacturing Company, of Sterling, Illinois, began ex-

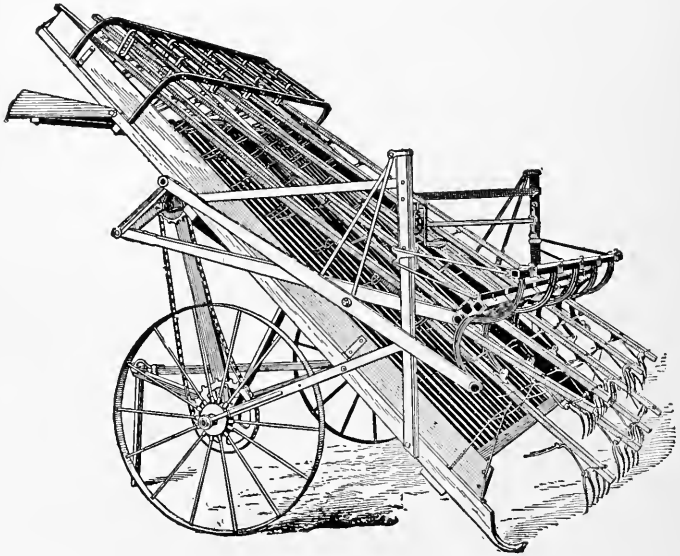

FIG. 130—A FORK HAY LOADER

perimenting with the hay loader as early as 1875. The machine is designed to be attached to the rear of the wagon, to gather the hay and elevate it to a rack on the wagon.

**253. Fork loader.**—In all of the early machines the hay was placed upon the elevating apron by tines or forks attached to oscillating bars extending up over the load. The hay was pushed along this apron by these oscillating bars with the tines on the under side. This form of loader worked very satisfactorily, but had one disadvantage in working in clover and alfalfa. The oscillating bars were unsatisfactory, as they shook the leaves out of the hay. This led to the introduction of an endless apron, which works very satisfactorily in this respect. The loader equipped with oscillating forks is of much more simple construction than the other type. It also has an advantage in being able to draw the swath of hay together at the top, and force it upon the wagon. Loaders of this kind are made without gears by increasing the throw of the forks. These machines have not as yet demonstrated their advantages.

**254. Endless apron loaders.**—The hay is elevated in this type of loader on an endless apron or carrier after it has been gathered by a gathering cylinder. The main advantage of this type of loader is that it does not handle the hay as roughly as the fork loaders. This is an important feature in handling alfalfa and clover, as there is a tendency to shake out many of the leaves, a valuable part of the hay. Due provision must be made, however, to prevent the hay from being carried back by the carrier returning on the under side. The apron or carrier usually passes over a cylinder at the under side, which has teeth to aid in starting the hay up the carrier.

Provision must be made to enable the gathering cylinder to pass over obstructions and uneven ground. For this reason the gathering cylinder is mounted upon a separate frame and the whole held to the ground by suitable springs. The loader has a great range of capacity.

All modern machines will load hay from the swath or the windrow, and the carrier will elevate large bunches of hay without any difficulty.

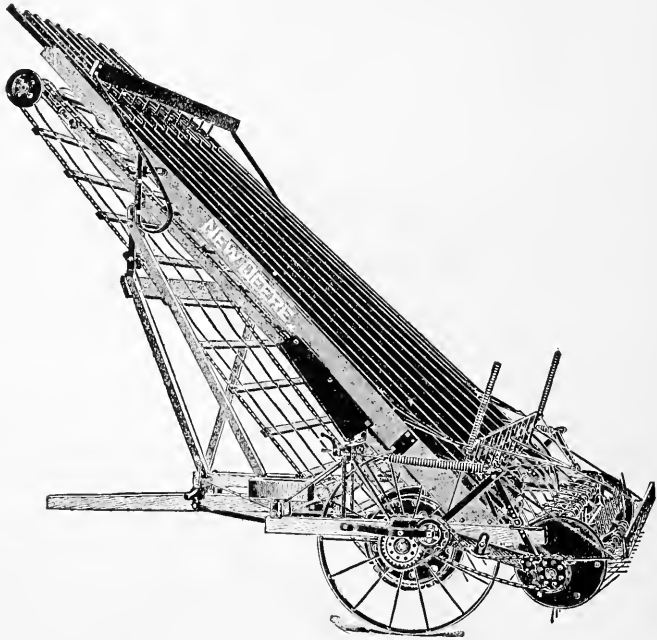

FIG. 131—AN ENDLESS APRON OR CARRIER HAY LOADER

### MACHINES FOR FIELD STACKING

255. **Sweep rakes.**—Where a large amount of hay is to be stacked in a short time, the sweep rake and the hay stacker will do the work more quickly than is possible by any other means. The sweep rake has straight wooden teeth to take the hay either from the swath or windrow, and is either drawn between the two horses or pushed ahead. When a load is secured the teeth are raised,



the load hauled and placed upon the teeth of the stacker and the rake backed away.

There are three general types of sweep rakes: (1) the wheelless, with the horses spread to each end of the

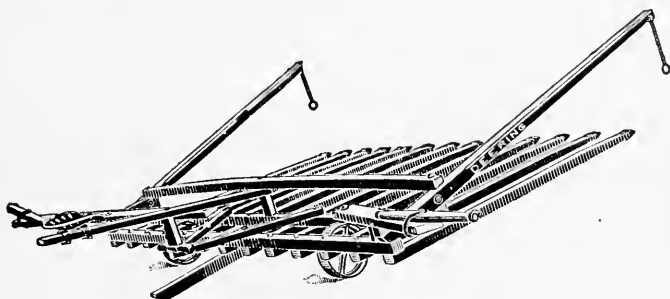

FIG. 132—A TWO-WHEEL SWEEP RAKE. THE TEETH ARE RAISED BY THE DRIVER SHIFTING HIS SEAT

rake; (2) the wheeled rake, with the horses spread in the same manner; and (3) the three-wheel rake, with the horses directly behind the rake and working on a tongue.



FIG. 133—A THREE-WHEEL SWEEP RAKE. THE DRIVER IS AIDED IN LIFTING THE LOADED TEETH BY THE PULL OF THE HORSES

The latter are the more expensive. They offer advantages in driving the team, but are a little difficult to guide (Figs. 132 and 133).

256. **Hay stackers** are made in two general types: the **overshot** and the **swinging stacker**. In the overshot the

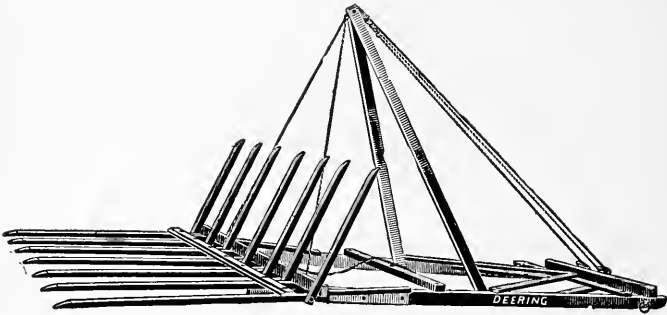

FIG. 134—A PLAIN OVERSHOT HAY STACKER

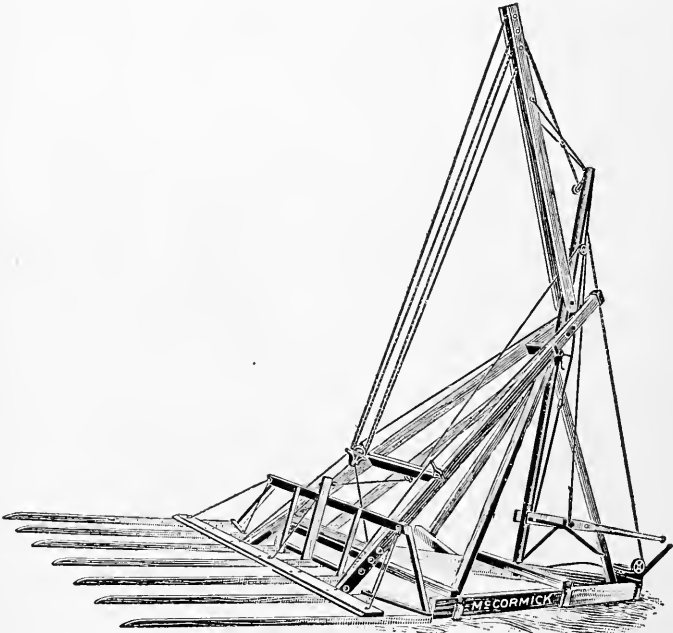

FIG. 135—THE SWING HAY STACKER. NOTE THE BRAKE AT THE REAR END FOR HOLDING THE ROPE

teeth carrying the load are drawn up and over and the load is thrown directly back upon the stack, the work being done with a horse or a team of horses by means of ropes and suitable pulleys (Fig. 134).

The swinging stacker permits the load to be locked in place after it has been raised from the ground to any height and swung to one side over the stack. When over the stack, the load may be dumped and the fork swung back and lowered into place. The latter stackers are very handy, as they may be used to load on to a wagon. They have not as yet been built strong enough to stand hard service.

**257. Forks.**—A cable outfit may be arranged with a carrier and fork for field stacking, the cable being stretched between poles and supported with guy ropes. This outfit works the same as the barn tools to be described later. Very high stacks may be built by this method.

A single inclined pole may be used in stacking by raising the fork load to the top and swinging over the stack. This is usually a home-made outfit, with the exception of fork and the pulleys.

## BARN TOOLS

**258. Development.**—The introduction of the field haying tools created a demand for machinery for the unloading of the load of hay at the barn, and this led to the development of a line of carriers and forks, the first of which was a harpoon fork, a patent for which was issued to E. L. Walfer, September, 1864. In 1873 a Mr. Nellis patented a locking device, which has given to this fork the name of Nellis fork.

J. E. Porter began the manufacture of a line of carriers

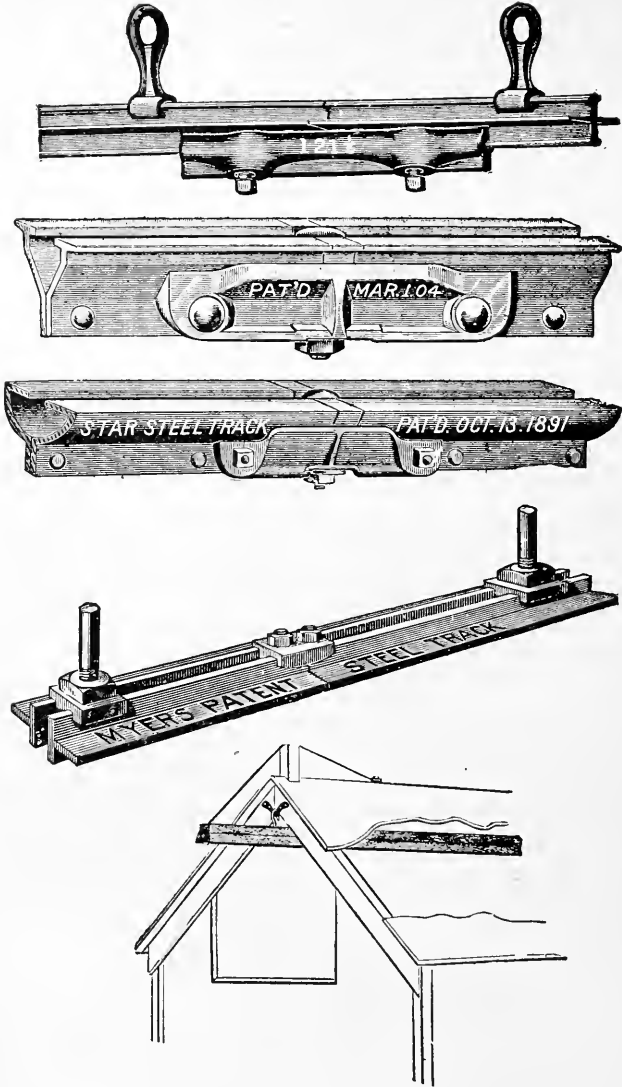

FIG. 136—TYPES OF STEEL AND WOOD HAY CARRIER TRACKS

and hay tools at Ottawa, Illinois, in 1868. This firm is still doing business. P. A. Meyers was another pioneer in the hay tool business, and in 1866 patented a double track made of two T-bars. In 1887, J. E. Porter placed upon the market a solid steel rail.

**259. Tracks.**—A large variety of tracks is to be found upon the market to-day—the square wooden track, the two-piece wooden track, the single-piece inverted T steel track, the double steel track made of two angle bars, and various forms of single- and double-flange steel tracks. Wire cables are used in outdoor work.

Various forms of track switches and folding tracks are to be found upon the market. By means of a switch it is possible to unload hay at one point and send it out in four different directions. In circular barns it is possible to arrange pulleys in such a way that the carrier will be carried around a circular track.

**260. Forks** are built in a variety of shapes and are known as single-harpoon or shear fork, double-harpoon fork, derrick forks, and four-, six-, and eight-tined grapple forks. To replace the fork for rapid unloading of hay,

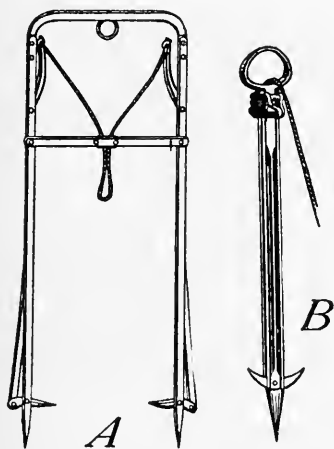

FIG. 137—*A*, DOUBLE-HARPOON HAY FORK. *B*, SINGLE-HARPOON HAY FORK

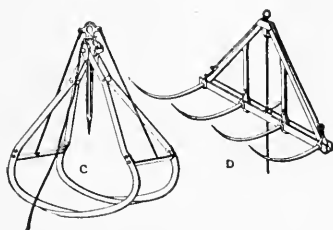

FIG. 138—*C*, A FOUR-TINED GRAPPLE FORK. *D*, A DERRICK FORK

the hay sling is used. The harpoon forks are best adapted for the handling of long hay, like timothy. For handling clover, alfalfa, and the shorter grasses, the grapple and derrick forks are generally used. The derrick fork is a popular style for field stacking in some localities. Harpoon forks have fingers which hold the hay upon the tines until tripped. The tines are made in lengths varying from 25 to 35 inches, to suit the conditions. The grapple fork opens and closes on the hay like ice tongs. The eight-tined fork is suitable for handling manure.

The hay sling consists of a pair of ropes spread with wooden bars and provided with a catch, by which it may

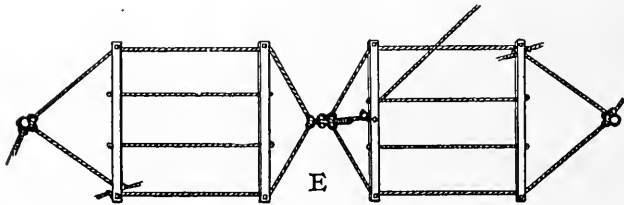

FIG. 139—A HAY SLING. THE SPRING CATCH BY WHICH THE SLING IS PARTED IS ABOVE *E*

be separated at the middle for discharging a sling load. The sling is placed at the bottom of the load, and after sufficient hay has been built over it for a sling load, another sling is spread between the ends of the hay rack and another sling load is built on, and so on. Four slings are usually required for an ordinary load; however, the number has been reduced to three, and even two. The sling is a rapid device, but is somewhat inconvenient in the adjusting of the ropes and placing in the load. It is very convenient at the finish. If the standard sling carrier is used, it is necessary

rack, requiring little hand labor. The most popular method at the present time is to use forks to remove all the load but one slingful, which is removed by a sling placed in the bottom of the load. This method circumvents the necessity of building slings into the load or hand labor in cleaning up the load for the fork at the finish. If the standard sling carrier is used, it is necessary

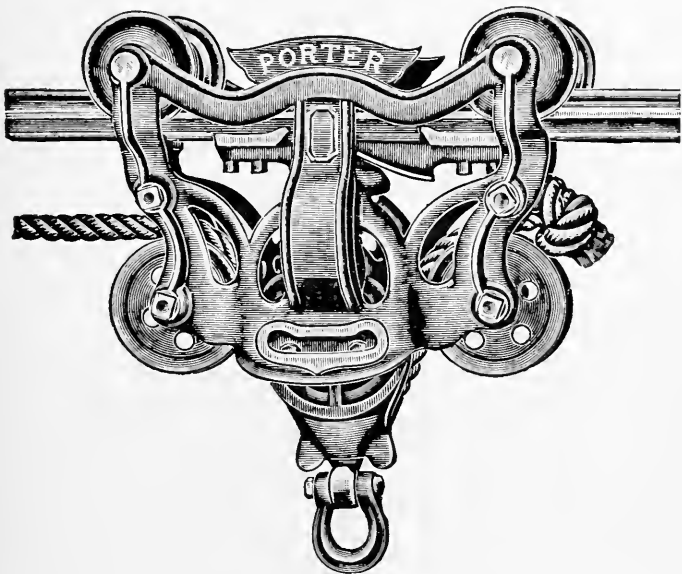

FIG. 140—A TWO-WAY FORK HAY CARRIER. TO WORK IN THE OPPOSITE DIRECTION, THE ROPE IS SIMPLY PULLED THROUGH UNTIL THE KNOT ON THE OPPOSITE END IS STOPPED BY THE CARRIER

to use two forks; however, a special fork and sling carrier will permit the use of a single fork.

**261. Carriers.**—Carriers are made to suit all of the various forms of tracks and are made one-way, swivel,

and reversible. In order to work the one-way from both ends of a barn it is necessary to take it off the track and reverse. The swivel needs only to have the rope turn to the opposite direction, while in the reversible the rope is knotted at each end, and when it is desired to work

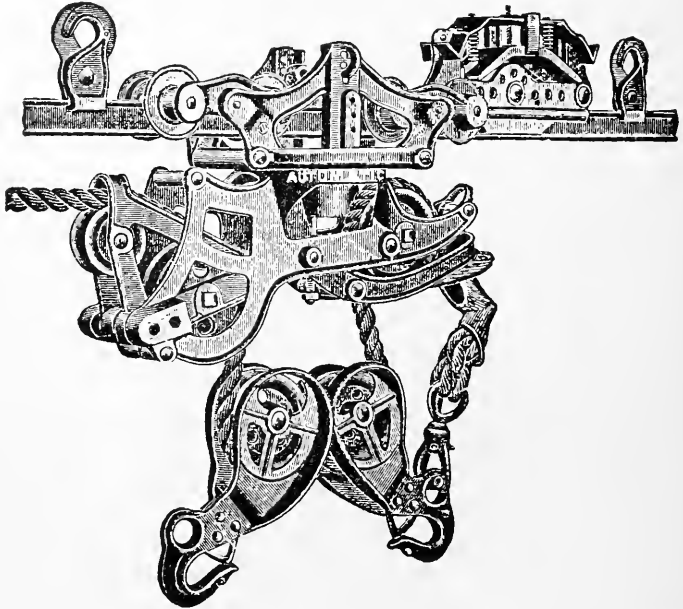

FIG. 141—A DOUBLE-CARRIAGE REVERSIBLE SLING CARRIER. DESIGNED FOR HEAVY SERVICE

from the other end of the barn all that is necessary is simply to pull the rope through the other way.

There are numerous devices to be used with barn outfits, carrier returns, pulley-changing devices, which are very handy, but need only be mentioned here.



## BALING PRESSES

262. **Development.**—Many patents were granted on baling presses during the early half of the past century, indicating the rise of the problem of compressing hay into a form in which it could be handled with greater facility. It was not, however, until 1853 that H. L. Emery, of Albany, N. Y., began the manu-



FIG. 142—A LIGHTER SLING CARRIER LOADED WITH A SLING LOAD OF HAY

facture of hay presses. It is stated that this early machine had a capacity of five 250-pound bales an hour and required two men and a horse to operate it. It made a bale  $24 \times 24 \times 48$  inches.

The next man to devote his efforts toward the development of a hay press with any success was P. K. Dederick, who began his work about 1860. He produced a practical hay press.

George Ertel was the pioneer manufacturer of hay presses in the West. His first efforts were in 1866, and from that time he devoted practically his entire time to the manufacture of hay presses. His first machine was a vertical one operated by horse power. Now both steam and gasoline engines are used to furnish the power.

263. **Box presses** are used very little at present, being superseded by the continuous machines of larger capacity. The box press consists in a box through which the plunger or compressor acts vertically, power being furnished either by hand or by a horse. The box, with the plunger down, is filled with hay; the plunger is then raised, compressing the hay into, usually, the upper end, where it is tied and removed. The machine is then prepared for another charge.

264. **Horse-power presses** are either one-half circle or full circle. In the half-circle or reversible-lever presses



FIG. 143—A FULL-CIRCLE HORSE HAY PRESS ON TRUCKS FOR TRANSPORTATION

the team pulls the lever to one side and then turns around and pulls it to the other side. The hay is placed loose in a compressing box, compressed at each stroke and pushed toward the open end of the frame, where it is held by tension or pressure on the sides. When a bale of sufficient length is made a dividing block is inserted and the bale tied with wire.

In the full-circle press the team is required to travel in a circle. Usually two strokes are made to one round

of the team. Various devices or mechanisms are used to obtain power for the compression. It is desired that the motion be fast at the beginning of the stroke, while the hay is loose, and slow while the hay is compressed during the latter part of the stroke. The cam is the most common device to secure this; however, gear wheels with a

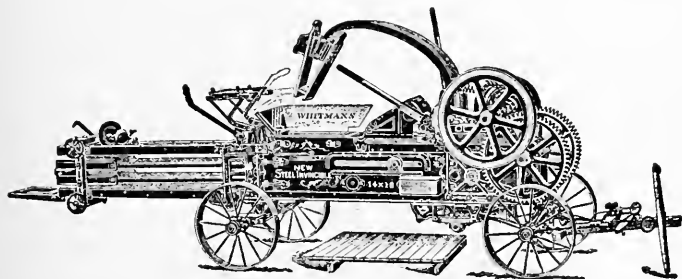

FIG. 144—A HAY PRESS FOR ENGINE POWER AND EQUIPPED WITH A CONDENSER TO THRUST THE HAY INTO THE HOPPER

cam shape are often used. The rebound aided by a spring is usually depended upon to return the plunger for a new stroke; but a cam motion may be made use of to return the plunger. It is to be noted that some machines use a stiff pitman and push away from the power, while others use a chain and rod and pull the pitman toward the power or reverse the direction of travel of the plunger. A horse-power machine has an average capacity of about 18 tons a day. A cubic foot of hay before baling weighs 4 or 5 pounds when stored in the mow or stack. A baling press increases its density to 16 or 30 pounds a cubic foot. Specially designed presses for compressing hay for export secure as high as 40 pounds of hay a cubic foot.

265. **Power presses** make use of several variable-speed devices and a flywheel to store energy for compression. Power machines are often provided with a condenser to

thrust the hay into the hopper between strokes. The common sizes of bales made are  $14 \times 18$ ,  $16 \times 18$ , and  $17 \times 22$  inches in cross-section, and of any length. A new baler has appeared which is very rapid, making round bales tied with twine. The machine can readily handle the straw as it comes from a large thresher. Plunger presses are built with a capacity up to 90 tons a day.

## CHAPTER IX

### MANURE SPREADERS

**266. Manure as a fertilizer.**—Although the manure spreader has been a practical machine for some time, it is only recently that its use has become general. This is especially true in the Middle West, where for a long time the farmer did not realize the need of applying manure, owing to the stored fertility in the soil when the native sod was broken, and cultivated crops grown for the first time. It has been proved that manure has many advantages over commercial fertilizer for restoring productivity to the land after cropping. It has been estimated by experts of the United States Department of Agriculture that the value of the fertilizing constituents of the manure produced annually by a horse is \$27, by each head of cattle \$19, by each hog \$12. The value of the manure a ton was also estimated at \$2 to \$7. It is not known from what data these estimates were made. The value of manure as a fertilizer does not depend solely upon the fact that it adds plant food to the soil, but its action renders many of the materials in the soil available and improves the physical condition of the soil.

**267. Utility of the manure spreader.**—As it was with the introduction of all other machines which have displaced hand methods, there is much discussion for and against the use of the manure spreader. The greatest advantage in the use of the manure spreader lies in its ability to distribute the manure economically. Experiment has shown that, in some cases at least, as good

results can be obtained from eight loads of manure to the acre as twice that number. It is impossible to distribute and spread by hand in as light a distribution as by the spreader. The manure is thoroughly pulverized and not spread in large bunches, which become fire-fanged and of little value as a fertilizer. It is a conservative statement that the manure spreader will make a given amount of manure cover twice the ground which may be covered with hand spreading. Since a light distribution may be secured, it can be applied as a top dressing to growing crops, such as hay and pasture, without smothering the crop. The manure spreader also saves labor. It is capable of doing the work of five men in spreading manure. With a manure loader or a power fork it is possible to handle a large amount of manure in a short time.

**268. Development.**—The first attempts at the development of a machine for automatically spreading fertilizer were contemporaneous with a machine for planting or seeding. In 1830 two brothers, by the name of Krause, of Pennsylvania, patented a machine for distributing plaster or other dry fertilizer. This machine consisted of a cart with a bottom sloping to the rear, where a transverse opening was provided with a roller underneath. This roller was driven by a belt passed around one of the wheel hubs. It fed the fertilizer through the opening.

The first apron machine was invented by J. K. Holland, of North Carolina, in 1850. The endless apron was attached to a rear end board and passed over a bed of rollers and around a shaft driven by suitable gearing at the front end of the cart. After the box had been filled with fertilizer and the apron put in gear, it drew the fertilizer to the front and caused it to drop little by little over the front end.

The first spreader of the wagon type was produced by J. H. Stevens, of New York, in 1865. His machine had an apron which was driven rearward by suitable gearing to discharge the load and was cranked back into position for a new load. The later machines were provided with vibrating forks at the rear end,

which fed the manure to fingers extending to each side, and securing in this way a better distribution of the fertilizer than the former ways. Thomas McDonald, in 1876, secured a patent on a machine much like the Stevens machine, except that it was

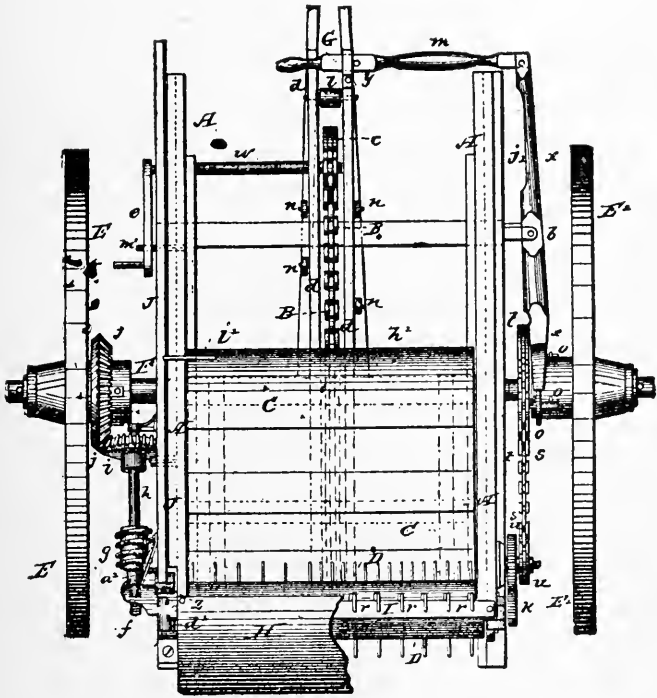

FIG. 145—THE J. S. KEMP MACHINE OF 1877. (FROM A PATENT OFFICE DRAWING)

provided with an endless apron passing around the roller at each end of the vehicle.

Many of the ideas of the modern spreader made their appearance in the patent of J. S. Kemp, granted in 1877. The objects of the invention read as follows: "To provide a farm wagon or cart with a movable floor composed of slats secured to an endless belt or chain. To the foremost slat an end board is secured,

which, when the machine is in forward motion, moves by a suitable gearing slowly to the rear, thus propelling the material that may be loaded in the vehicle against a rotating toothed drum, which pulverizes and evenly spreads the load on the ground behind."

A spreader with a solid bottom to the box over which the manure was drawn by chains with slats across and attached to an end board, appeared in 1884. Variable-speed devices for varying the rate of distribution were provided at the same time.

An endless apron machine appeared in 1900, with hinged slats which overlapped while traveling rearward, and which hung downward while traveling ahead on the under side, making an open apron. There is a tendency on the part of endless apron machines to become fouled by the manure which passes through the apron on the upper side and lodges on the inside of the lower half.

It would be impracticable to mention all of the improvements to manure spreaders along the line of return motions, variable-feed devices, safety end boards, and almost countless details in the construction of bed, apron, and beater.

## THE MODERN SPREADER

The modern manure spreader consists essentially in (a) a box with flexible apron for a bottom, (b) gearing to move the apron to the rear at a variable speed, and (c) a toothed drum or beater to pulverize and spread the manure evenly behind.

**269. Aprons.**—Three types of aprons or box bottoms are to be found in use on the modern spreader: (a) a **return apron** (Fig. 146), with an end board which pulls the load to the beater by being drawn under the box; (b) the **endless apron** (Fig. 147), which is composed of slats or bats passing continuously around reels at each end of the box; and (c) bars or a push board, moved by chains, thus moving the load to the beater over a solid floor.



The endless apron spreader is perhaps of more simple construction than the others, as no return motion is needed to return the apron for another load. It will not distribute the load well at the finish because it does not

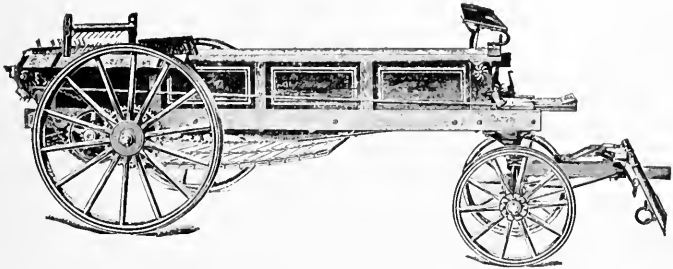

FIG. 146—A RETURN APRON SPREADER, SHOWING THE APRON UNDERNEATH, AND ALSO A GEAR AND CHAIN DRIVE TO BEATER

have the end board to push the last of the load to the beater. There is also some difficulty in preventing the inside of the apron from being fouled with manure. One make overcomes this difficulty by hinging the slats in a



FIG. 147—AN ENDLESS APRON

way that they may hang vertically while on the lower side. To prevent fouling, the endless apron may be covered with slats for only half its length. The chain apron without doubt requires much more power than the others, since the weight is not carried upon rollers. Some

spreaders have an advantage over others in the arrangement of rollers and the track on which they roll. The rollers may be either attached to the bed or to the slats.

**270. Main drive.**—The main drive to the beater varies with different machines. The power may be taken from the main axle with a large gear wheel or by means of a large sprocket and a heavy chain or link belt. It is

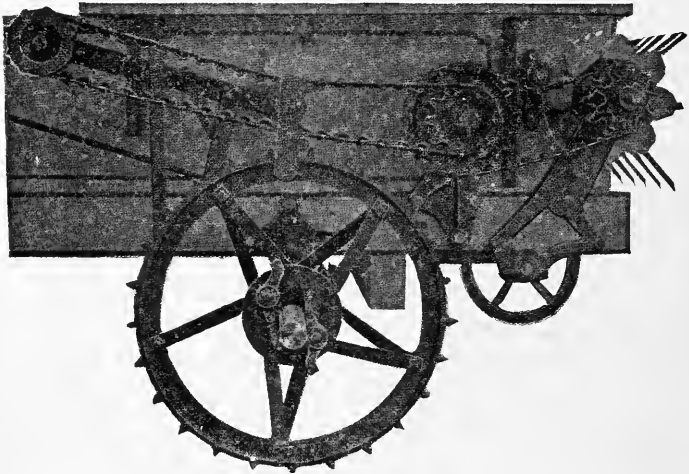

FIG. 148—A CHAIN DRIVE TO THE BEATER. NOTE THE METHOD OF REVERSING THE MOTION

almost universal practice to use a combination of a chain and a gear in the drive. The speed of the beater must be such that the power must be increased twice, while the direction of rotation must be reversed. To reverse the direction of the motion, the gear is used. The heavy chain or link belt offers some advantage in case of breakage. A single link may be replaced at a small cost, while if a tooth is broken from a large gear the entire wheel must be replaced.

The use of gears is avoided entirely in at least one make by passing the drive chain over the top of the main sprocket and back instead of around it. This reverses the direction of rotation (Fig. 148). Some spreaders are so arranged that a large part of the main drive must be kept in motion even when the machines are out of gear. The gearing must be well protected, or it

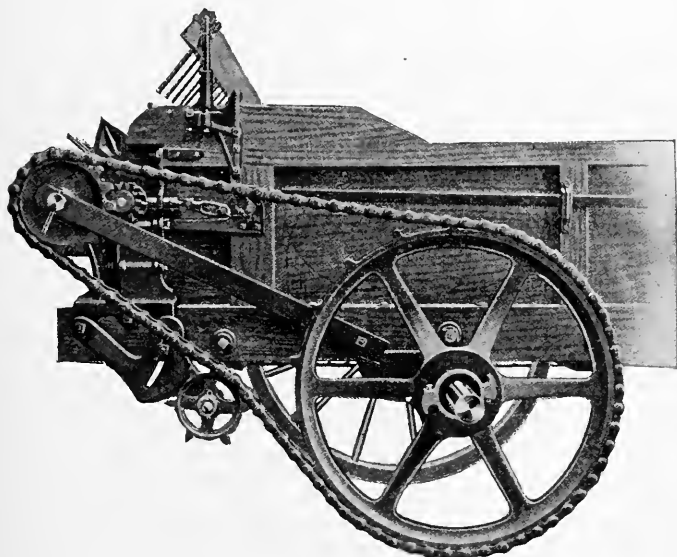

FIG. 149—A CHAIN AND GEAR DRIVE TO THE BEATER. THE BEATER IS PLACED IN GEAR BY MOVING BACK UNTIL GEARS MESH

will become fouled in loading. The **main axle** must be very heavy on a spreader, as a large share of the load is placed upon it, and it must not spring or it will increase the draft greatly. Large bearings should be provided with a reliable means of oiling and excluding dirt.

**271. Beaters.**—The beater is usually composed of eight bars filled with teeth or pegs for tearing apart and pul-

verizing the manure (Fig. 150). Some variance is noticed in the diameter of the beater and its location as to height. It is claimed by certain manufacturers that much power

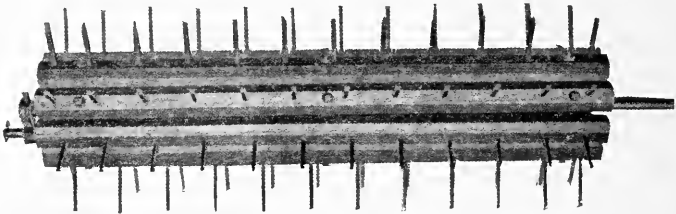

FIG. 150—A MANURE SPREADER BEATER

may be saved by building the beater large and placing it low; in this way there is no tendency to compress the manure on the lower side of the beater, as it is not necessary to carry the manure forward and up. When a

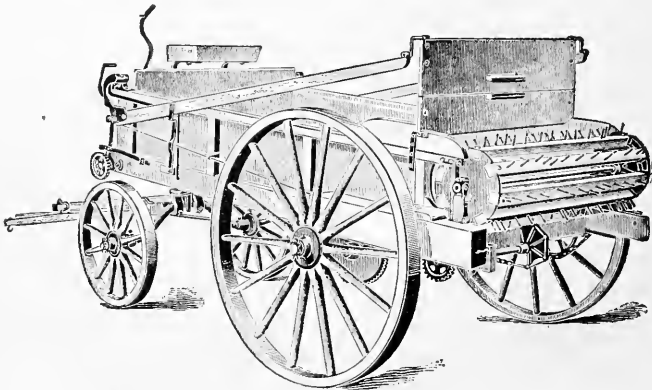

FIG. 151—A MANURE SPREADER WITH AN END BOARD TO BE PLACED IN FRONT OF THE BEATER

beater is so placed it does not have the pulverizing effect it would have otherwise. When a load is placed upon a spreader it is usually much higher and more compact in

the center. If due provision is not made, the spreader will spread heavier at the center than at the sides. One beater has the teeth arranged in **diagonal rows**, tending to carry the manure from the center to the sides. Several have **leveling rakes** in front of the beater, and at least one a vibrating rake, to level and help pulverize the manure. If no provision is made, the front of the beater will be filled with manure while loading, and the

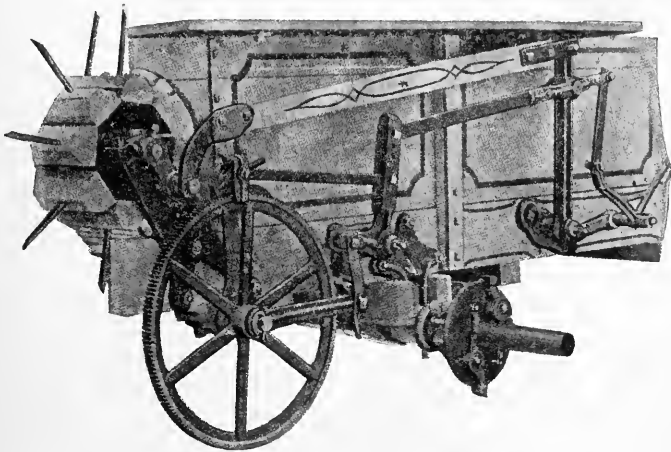

FIG. 152—A RATCHET DRIVE FOR THE APRON. NOTE METHOD OF VARYING THE FEED

machine will not only be difficult to start, but will carry over a heavy bunch of manure when put in motion. To surmount this difficulty, the beater in some makes is made to move back from the load when put in gear. A few machines have an end board, which is dropped in front of the beater while the load is put on, and lifted when spreading is begun.

**272. Apron drives.**—At least two systems of apron drives are in use: (a) the ratchet, and (b) the screw or

worm gear drive, the feed being regulated in the latter case with a face gear or cone gears and a flexible shaft. The ratchet drive (Fig. 152) has an advantage in offering a great range of speed. As many as ten speeds for the apron, or in reality ten rates of feed, may be obtained. However, the motion is intermittent and heavy strains are thrown upon the driving mechanism by the sudden starting of the heavy load. The ratchet drive is liable to breakage and does not prevent the load from feeding too fast in ascending a hill owing to the tendency of the

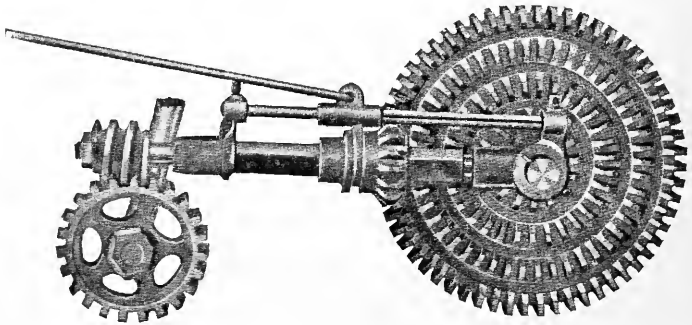

FIG. 153—THE WORM GEAR DRIVE TO THE APRON. ALSO FACE GEAR FOR VARYING THE FEED

load to run back. To prevent this a brake is used, but must be unsatisfactory.

The worm drive, on the other hand, gives a constant motion to the apron, but does not offer a great variety of feeds, and unless carefully attended to wears out quickly. Fig. 153 shows a worm drive with a face gear for varying the feed. The worm drive must be greased several times each day or it will cut out. It has been known for a worm gear to wear out in a single day's work. The cone gear for varying the speed is very little used, but seems to be a satisfactory drive.

**The return motion** is usually independent of the forward motion, a safety device being arranged to prevent both forward and return motions being put in gear at the same time. In the early machines the apron was returned by hand, but now power is universally used. A crank is sometimes provided by which the apron may be returned by hand if desired. The endless apron, of course, requires no return motion.

**273. Wheels.**—At the present time there is some discussion in regard to the merits of wood and metal wheels for manure spreaders. The large cast hub needed to carry the driving pawls or the main ratchet is favorable to the use of a wood wheel. This type of wheel has been displaced on practically all other implements, and it is safe to venture an opinion that it will be displaced in time on the manure spreader. Wide tires of 5 or 6 inches are essential on the manure spreader. In order to secure greater traction the wheels must often be provided with **grouters** or **traction bands**. The traction band may be removed when not needed, permitting the spreader to travel more smoothly over hard ground.

**274. Trucks.**—As now constructed, the manure spreader has a low front truck arranged to turn under the bed. A low truck offers an advantage in loading, but undoubtedly is of heavier draft. A narrow front truck prevents a lashing of the neck yoke in passing over uneven ground.

**275. The frame** of a manure spreader must be constructed of good material, and should also be well braced and trussed with iron rods. Not only must the material be strong, but also able to resist the rotting action of the manure.

**276. Simplicity.**—It is desirable that the manure spreader as well as other machines shall be as simple as

possible. Multiplied systems of gearing and levers are not desirable on any machine. The best results are obtained from few working parts, provided they will do the work.

**277. Sizes.**—The capacity of manure spreaders is given in bushels, yet there appears to be very little connection between the bushel and capacity of manure spreaders. By measuring, it has been found that certain spreaders' capacity would be more nearly correct if given in cubic feet instead of bushels.

**278. Drilling attachment.**—To apply manure to growing crops planted in rows and to economize the manure, a drilling attachment is provided. It consists in a hood for the beater, with funnels below, from which the manure is discharged beside or on each row. The attachment may also be used to distribute lime and other fertilizers.

**279. Other uses.**—The manure spreader may be used to distribute straw and other material for mulching. With the beater removed, the manure spreader may be used as a dump wagon for hauling and dumping stone, gravel, etc. It is especially useful in hauling potatoes and root crops where they are to be dumped into a chute leading to the root cellar. The apron in this case is moved back by hand power by means of a crank provided for the purpose.



## CHAPTER X

### THRESHING MACHINERY

**280. Development.**—In the oldest of writings mention is made of the crude devices by which grain in the ancient times was separated from the straw. Although mention of mechanical devices was made at a very early time, the two methods which came into extended use were treading with animals and beating the grains from the ears with a flail. The flail was nothing more nor less than a short club usually connected to a handle with a piece of leather. This long handle enabled the operator to remain in an upright position and strike the unthreshed grain upon the floor a sharp blow. After the grain was threshed from the head or ear, the straw was carefully raked away and the grain separated from the chaff by throwing it into the air and letting the wind blow out the chaff, or by fanning while pouring from a vessel in a thin stream. Later a fanning mill was invented to separate the grain from the chaff.

Flailing was the common method of threshing grain as late as 1850. In regard to the amount of grain threshed in a day with a flail, S. E. Todd makes the following statement in Thomas's book on Farm Machinery: "I have threshed a great deal of grain of all kinds with my own flail, and a fair average quantity of grain that an ordinary laborer will be able to thresh and clean in a day is 7 bushels of wheat, 18 bushels of oats, 15 bushels of barley, 8 bushels of rye, or 20 bushels of buckwheat."

**281. Early Scotch and English machines.**—About the year 1750 a Scotchman named Michael Menzies devised a machine which seems to have been nothing more nor less than several flails operated by water power. This machine was not practical, but in 1758 a Mr. Lechie, of Stirlingshire, England, invented a machine with arms attached to a shaft and inclosed in a case. Lechie's machine gave the idea for the more successful machines which came later.

A Mr. Atkinson, of Yorkshire, devised a machine (the date is



FIG. 154—A THRESHING MACHINE IN OPERATION. THE GRAIN IS SUPPLIED TO THE MACHINE FROM ONE SIDE IN ORDER TO OBTAIN A BETTER VIEW OF THE MACHINE

not known) having a cylinder with teeth, or a peg drum, as it was called, and these teeth ran across other rows of teeth, which acted as concaves.

**282. American development.**—The Pitts brothers have figured more prominently than any two other men in the early development of threshing machines in America. Others were granted patents, but to these men credit should be given for inventing and manufacturing the first practical machine. These brothers

were Hiram A. and John A. Pitts, of Winthrop, Maine. A patent was granted to them December 29, 1837, on a thresher, the first of the "endless apron" type. This machine was made not only to thresh the grain, but to separate it from the straw and the chaff. Although this machine as constructed by the Pitts brothers was different from the modern separator, it contained many of the essential features. It had but a single apron. The tailings elevator returned the tailings behind the cylinder over

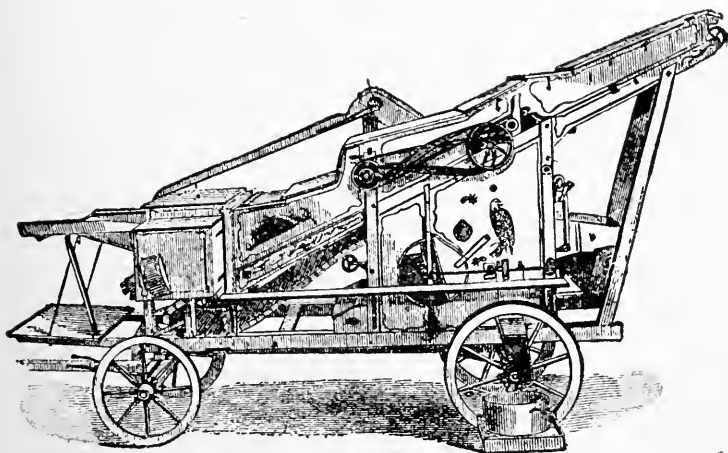

FIG. 155—THRESHING MACHINE OF 1867

the sieves to be recleaned, instead of into the cylinder, as now arranged.

In the Twelfth Census Report, the following statement is made: "The first noteworthy threshing or separating machine invented in the United States which was noticeable was that of Hiram A. and John A. Pitts, of Winthrop, Maine, and may be said to be the prototype of the machines used at the present time."

The first machines and horse powers to drive them were satisfactory. The machine was finally made so it could be loaded on trucks, transported from place to place, and set by removing the trucks and staking to the ground. This type of machine received the name of "groundhog thresher." Later the machines

were mounted on wheels, and hence were quite portable. The

early horse power consisted of a vertical shaft mounted between beams, to which a sweep was attached. The power was taken by a tumbling rod from a master wheel mounted above. This type earned the name of "cider-mill" power. Tread power was used largely to operate the early threshers, and water power to some extent. John A. Pitts finally located a factory at Buffalo, New York, and the "Buffalo Pitts" thresher became well known throughout the country. This machine is manufactured to-day with some of the original features. John Pitts died in 1859. Hiram A. Pitts moved to Chicago in 1852 and established a factory which built what was known as the "Chicago Pitts." He died in 1860. Much credit is due to these men for the development of a practical threshing machine.

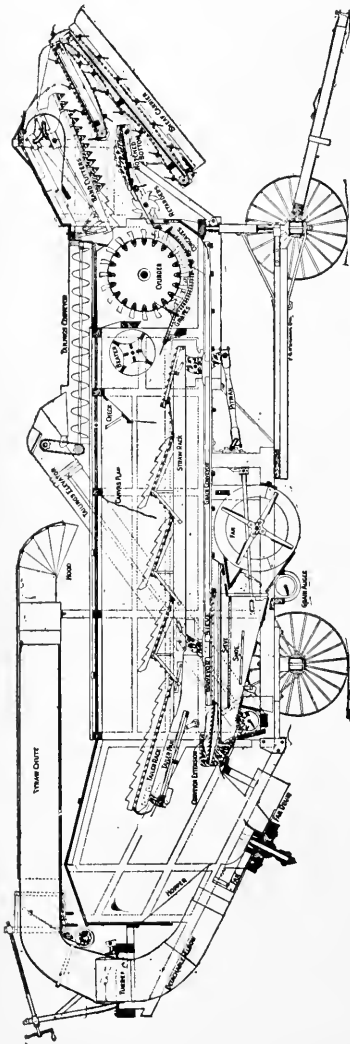

FIG. 150—SECTION OF A MODERN THRESHING MACHINE

### THE MODERN THRESHING MACHINE OR SEPARATOR

283. Operations.—The threshing machine as it is constructed to-day performs four distinct opera-

tions. These operations and the parts that are called upon to perform them in most machines may be enumerated as follows:

*First*, shelling the grain from the head. The parts which do the shelling or the threshing are the cylinder and the concaves with their teeth. Fig. 157 shows these parts.

*Second*, separating the straw from the grain and chaff. The parts which perform this operation are the grate, the beater, the checkboard, and the straw rack, or riddle.

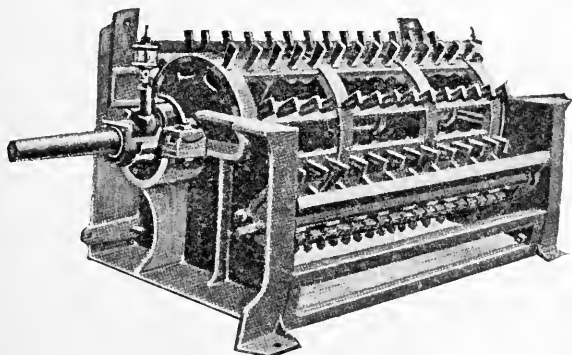

FIG. 157—THE CYLINDER AND CONCAVE

*Third*, separating the grain from the chaff and dirt, performed by the shoe, fan, windboard, screens, and tailings elevator.

*Fourth*, delivering the grain to one place and the straw to another, which is accomplished by the grain elevator and the stacker or straw carrier.

Other attachments, as the self-feeder and weigher, are often provided.

These parts will now be discussed somewhat in detail.

**284. Cylinder.**—The cylinder is usually made by attaching parallel bars to the outer edge of spiders mounted on the cylinder shaft. The whole is made very rigid by

shrinking wrought-iron bands over the bars. A solid cylinder may be used instead of the bars. The bars in some makes are made of two pieces, and hence are called **double-barred** cylinders. The teeth are held in place by nuts or wedges, and are often provided with lock washers. Wooden bars may be placed under the nuts and act as a cushion, preventing the teeth from loosening as readily as otherwise. The cylinder has usually 9, 12, or 20 bars, the latter being spoken of as a big cylinder.

The cylinder travels with a peripheral speed of about 6,000 feet a minute. The usual speed for the 12-bar cylinder is 1,100 revolutions per minute, and of the 20-bar cylinder is 800 revolutions per minute. A large amount of power is stored in the cylinder when in motion and enables the machine to maintain its speed when an undue amount of straw enters the cylinder at a time.

The kernels of grain should be removed from the heads and retaining hulls in passing through the cylinder. The other devices in the machine do not have a threshing effect. In threshing damp, tough grain, a higher speed must be maintained than when threshing dry grain. It is attempted, however, to run the cylinder at about uniform speed in nearly all cases.

As the cylinder is heavy and travels at a high speed, it must be properly balanced, or it will not run smoothly. In the factory the cylinder is made up and then balanced by running at a high speed on loose boxes. The heavy side is located by holding a piece of chalk against the cylinder while in motion. When the cylinder teeth become worn they must be replaced with new teeth, which are heavier, so that there is a tendency to put the cylinder out of balance. After putting in new teeth the cylinder may be balanced by removing from the machine and mounting it on two level straight edges placed on saw

horses or trestles. Two steel carpenter's squares will answer for straight edges. The heavy side of the cylinder will be found, because it will come to rest at the lower side. Weights may be added in the shape of nuts and wedges to bring the cylinder into balance. This latter method will not bring the cylinder into perfect balance, as one end may be heavy on one side, while at the opposite end the other side will be the heavier, and the cylinder will appear to be in perfect balance on the straight edges.

The cylinder must have end adjustment in order that its teeth will travel directly between the concave teeth. If the cylinder teeth travel close to the concave teeth on one side they will crack the kernels and break up the straw, and thus leave a larger opening on the opposite side through which the grain may pass unthreshed. It is advisable that the cylinder shaft be heavy and equipped with self-aligning boxes provided with a reliable oiling device. Some machines are made with an "outboard" bearing on the pulley end of shaft, i. e., outside of main drive pulley. This arrangement is strong but somewhat difficult to line up, and the belt cannot be detached readily.

**285. The concave** received its name from its shape being hollowed out to conform to the shape of the cylinder. The concave carries teeth which resemble the cylinder teeth very much, and have openings through which some of the threshed grain may fall. It is made in sections, so the number of teeth may be varied by substituting different sections. It may be moved or adjusted to or from the cylinder. In some machines the adjustment may be made at the front and at the rear independently of each other, it being claimed that an advantage is gained by having the concave lower

at the rear in order that a larger opening be provided for the straw to pass through as it is expanded in the operation of threshing. As a rule, it is advisable to use few rows of concave teeth and set them well up against the cylinder, as there is little chance of the concave becoming clogged.

**286. Cylinder and concave teeth.**—The teeth in both the cylinder and the concave are curved backward slightly to prevent the straw being carried past the cylinder without being threshed. Teeth become more rounded by use and reduce the capacity and interfere with the proper working of the machine. It is stated that a very large amount of power is required when the teeth become rounded off. When worn the teeth should be replaced,



FIG. 158—THE GRATE AND CONCAVE

making it necessary to balance the cylinder before replacing in the machine, and also calling for watchfulness on the part of the thresher lest some of the new teeth become loose and cause damage. The teeth are usually made of a good grade of mild steel, yet certain manufacturers prefer tool steel with a hardened edge. No doubt the latter wear better.

**287. The grate** consists of parallel bars, with openings between, designed to retard the straw and allow a large portion of the grain to pass through to the grain conveyor before reaching the straw rack (Fig. 158).

**288. The beater.**—After passing through the cylinder and concave and over the grate the grain comes in con-



tact with the beater. The beater (Fig. 159) is a fan-like device which tends to carry the straw away from the cylinder and forms a stream of straw to pass over the straw rack. Some makers make use of two beaters, one above the straw and one below, in an effort to separate the grain and chaff from the straw. The beater must



FIG. 159—THE BEATER

run at high enough speed to enable the centrifugal force to prevent the straw from wrapping around it.

**289. The checkboard.**—The purpose of the checkboard is to stop the kernels which may be thrown from the beater. It is usually constructed of sheet iron and allowed to drag over the stream of straw.

**290. Straw rack.**—The straw rack is for the purpose of carrying the straw away from the cylinder and shaking

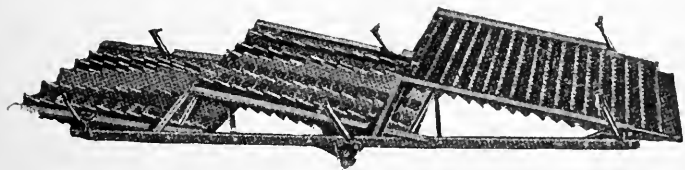

FIG. 160—ONE TYPE OF STRAW RACK

the grain down on the grain conveyor below. Straw racks are of three types: (a) endless apron or riddle type, (b) oscillating racks, (c) vibrating racks.

The endless apron or riddle rack consists of a web with thumpers underneath to shake the grain to the bottom. It is usually made in sections with an opening between which permits the grain and chaff to fall

through. The endless apron was the first device used and is now found in only a few machines, and there only in short lengths.

The oscillating rack is made in sections and attached to a crank shaft directly. The sections are made to balance each other and offer a great advantage in this respect. An oscillator is a very good device for separating the grain, but perhaps somewhat difficult to keep in repair.

The vibrating rack may be made in one or more sections. When made in one section there is usually an attempt to balance its motion with that of the grain pan. The rack is provided with notched fingers, called "fish-backs." These are given a backward and upward thrust by a pitman attached to a crank, causing the rack to swing on its supports. This motion causes the straw to move backward and at the same time be thoroughly agitated. Machines are constructed with two racks, the upper to carry off the coarse straw and a lower to separate the finer. The double rack permits of their motion being balanced the same as the rack built in two sections.

**291. The grain conveyor or grain pan** extends from under the cylinder back almost the full length of the machine. Its function is to convey the grain to the cleaning mechanism. It should be of light, yet strong, construction. It must not sag, or grain will be pocketed in such a manner that its motion will not cause it to pass on.

**292. Chaffer.**—At the end of the grain conveyor and really forming a part of it is the chaffer, which is a sieve with large openings permitting all but the coarse straw to pass through. A part of the blast from the fan passes through the chaffer, and a large portion is carried off in

this manner. At the back of the chaffer is placed the **tailings auger**, which catches the part heads and grains with the outer hulls, to return them by way of the tailings elevator to the cylinder to be rethreshed. Over the tailings auger an adjustable conveyor extension is usually placed to aid in stopping the unthreshed heads.

**293. The shoe.**—The shoe is the box in which the sieves are mounted, and which has a tight, sloping bottom to carry the threshed grain to the **grain auger**. The shoe is always given a motion to shake the grain through

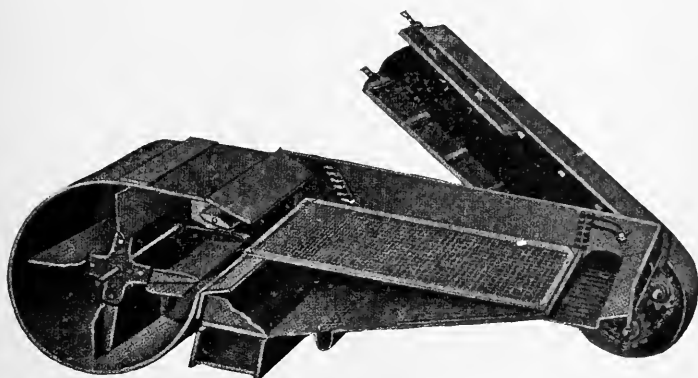

FIG. 161.—FAN, SHOE, AND CHAFFER

it. If this motion be lengthwise with the machine, it is said to have **end shake**; if across the machine, it is said to have **cross shake**. The latter is used very little at present.

**294. The sieves.**—The sieves consist of a wooden frame covered with woven wire cloth or a perforated sheet of metal. **Adjustable sieves** are constructed in which the size of openings may be adjusted to suit the work done. The openings in the sieve should be large enough to permit the passage of the kernel downward,

and of sufficient number to permit the blast to pass upward through it. The sieve must be well enough supported so it will not sag when loaded, or the grain will settle to the low spot and clog the sieve. The frame should be strong, and perhaps reënforced with a malleable casting at each of the corners.

295. **The fan** consists of a series of blades or wings mounted on a shaft. A blast is thus created to blow the chaff from the grain. An **overblast** fan delivers the blast backward from the blades at the upper portion of the fan drum. The **underblast** fan rotates in the opposite direction and delivers the blast from the lower blades. Since there is a tendency to create a stronger blast from the center of the fan than from any other part, bands are placed in the fan by some manufacturers to distribute the blast more evenly across the width of the shoe.

### ATTACHMENTS

296. **The self-feeder and band cutter.**—The work of the self-feeder is to cut the bands of the bound grain, distribute it across the mouth of the separator, and deliver it to the cylinder. To carry the bundles to the band cutters, the feeder must be provided with a carrier. A variety of carriers is found in use ranging from a solid canvas or rubber belt to two belts or link belts carrying slats. Both seem to be very satisfactory.

The band cutters may be knives attached to a rotating shaft, or knives similar to those in use upon mowers, the latter style of knife giving a chopping-like motion into the bundle, tending to draw them into the machine. It is claimed that this type is much better in remaining sharp for a longer time. It is not, however, of as simple construction.

Just before the grain enters the cylinder it is spread and more evenly distributed by the **retarders**, which also, as their name implies, prevent the grain from being drawn into the cylinder in bunches.

**297. Stackers.**—The straw carrier was for a long time the only means of carrying the straw away from the machine. This consisted in a chute, over the bottom of which the straw was drawn with a web. This developed from a carrier extending directly to the rear to an inde-

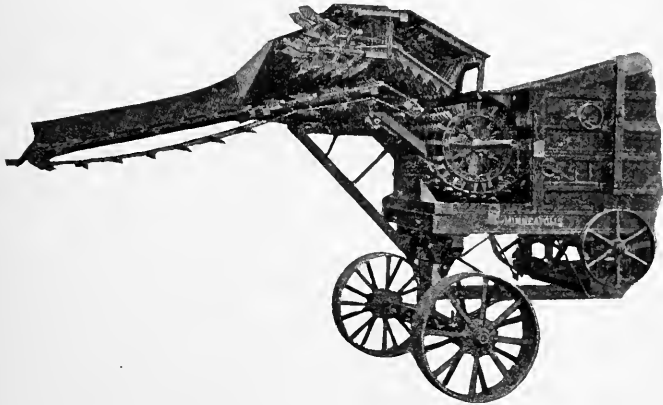

FIG. 162—A SECTIONAL VIEW OF A SELF-FEEDER

pendent swinging stacker and the attached swinging stacker. The former has gone out of use entirely, but the attached swinging stacker is used to some extent. It has some advantages over the wind stacker for barn work.

**298. The wind stacker or blower** has displaced the straw carrier to a large extent because it requires a smaller crew to operate. The wind stacker is made in many types. The fan drum is placed horizontal, inclined, or vertical; the straw may enter the fan direct or into the

blast after it has left the fan. The bevel gears by which the fan is often driven are a source of trouble if the gears do not mesh correctly from the beginning. They have been known to wear out completely in a few days' work. In order to obviate this trouble, the stacker drive belt is often required to make the turn over two pulleys and drive the fan direct. This method also gives some trouble.

The wind stacker without doubt requires more power than a straw carrier, but saves labor. It is impossible

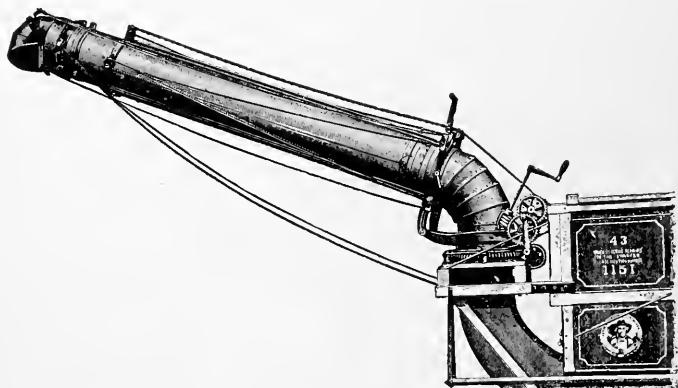

FIG. 163—A WIND STACKER. THE FAN DRUM IS NOT SHOWN

to save the straw as well, but often the straw is considered to be of little value.

**299. The weigher** is an attachment by which the threshed grain is weighed and measured as threshed. It is a very satisfactory arrangement to have on a machine doing custom work. The weigher is nearly always provided with an elevator by which the grain is elevated into the wagon box. To do the elevating, pans or buckets passing through a tube are used. A few pneumatic grain elevators have been used, but not to any extent. When it

is desired to place the grain in bags a **bagger** attachment is provided, which does not elevate the grain as high.

300. **Size and capacity of threshing machines.**—The size of a threshing machine is indicated by the width or

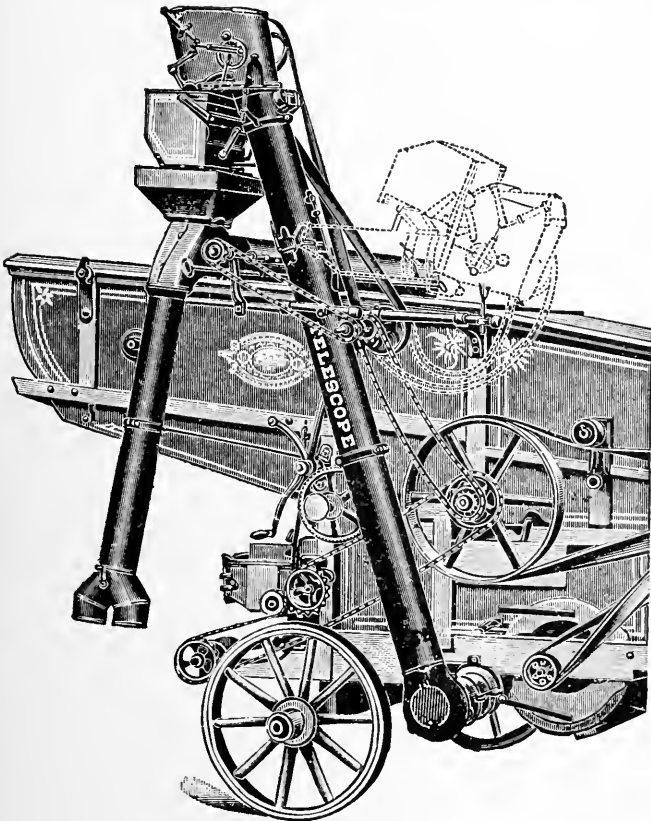

FIG. 164—A WEIGHER AND BAGGER

length of the cylinder and the width of the separator proper. The two dimensions in inches are written to-

gether. The size varies from  $18 \times 22$  inches to  $44 \times 66$  inches, but the  $32 \times 54$ -inch or  $36 \times 58$ -inch are the common sizes. The ratio between the width of cylinder and separator varies slightly with different makes. Steam traction engines are now generally used to furnish the power for the larger sizes, although gasoline engines are being introduced into the work. A  $36 \times 58$ -inch machine requires a 15- or 16-horse-power engine, as usually rated. For the smaller sizes, horse powers and portable gasoline engines are generally used. The amount of grain threshed a day will vary very much with the conditions of the grain. There is also a wide variance in the size of machines, but the average-sized steam-operated outfit will thresh from 500 to 1,000 bushels of wheat a day or twice that number of bushels of oats.

**301. Selection.**—The selection of a threshing machine depends upon many conditions, among which may be mentioned the kind and quantity of grain to be threshed, the amount of labor, the power, and the condition of the bridges in the locality. There has been a gradual increase in the size of threshing outfits for some time. These large machines have an enormous capacity and require a large force of men to run them. However, the small machine is still manufactured, and there is much argument in its favor, especially so since the introduction of portable gasoline engines of a size to operate it. Steel is made use of to a large extent in the manufacture of separators, and no doubt will prove to be a very durable material when galvanized. The threshing machine deserves good care on the part of the owner. It is an expensive machine, and much money can be saved by protecting it from the weather.

**302. Bean and pea threshers** differ from grain threshers in having two threshing cylinders operated at different



speeds. The two cylinders are necessary owing to the fact that these crops can never be cured uniformly. When the pods are dry the seeds are readily separated from the pods, and if threshed violently the seeds will split. On the other hand, when the pods are not dry the seeds cannot be separated readily and are not inclined to split. Thus in the special bean thresher the vines and pods are fed through a cylinder run at a low speed, which threshes out the dry pods. The threshed seeds are screened out, and the remaining material passes to a cylinder run at a higher speed to have the damp and greener pods

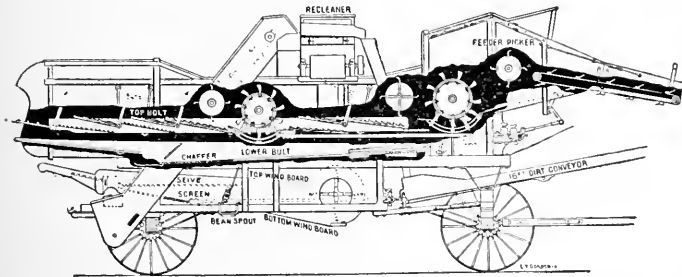

FIG. 165—SECTION OF A PEA AND BEAN THRESHER WITH TWO CYLINDERS

threshed. The bean thresher is often provided with a recleaner and clod crusher to remove the dirt. The size of the bean and pea threshers is indicated by the width of cylinder and the width of the separator or machine proper. Machines are usually built in the  $16 \times 28$ -,  $26 \times 44$ -, and  $36 \times 44$ -inch sizes. The larger sizes have a capacity up to 100 bushels of clean seed an hour.

303. **Clover hullers** resemble threshing machines very much, but differ in being provided with an additional hulling cylinder. In passing the threshing cylinder the heads are removed from the stems and the seed from the heads to some extent. The heads are separated from the

stems and chaff and passed to the hulling cylinder, which removes the seed from the pods. The construction of hulling cylinders varies from a cylinder with fluted teeth and a wooden cylinder with steel brads for teeth to a cylinder covered with hardened steel rasp plates. It is necessary in all cases to have a large amount of surface

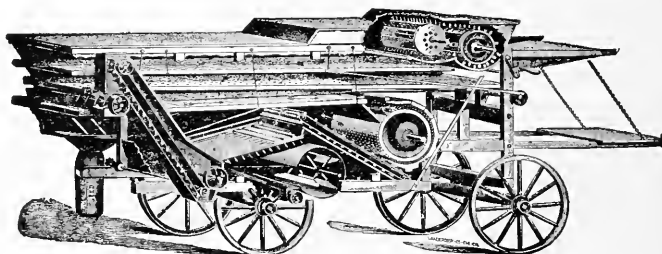

FIG. 166—SECTION OF A CLOVER HULLER

for the clover to come in contact with. Clover hullers are rated according to the size of the hulling cylinder, which may vary from 28 to 42 inches. The large machines are driven by steam power, while horse power may be used for the smaller. They may be provided with wind stackers, self-feeders, and baggers similar to threshing machines. They have a capacity up to 10 to 15 bushels of cleaned seed an hour.

## CHAPTER XI

### CORN MACHINERY

#### Feed and Silage Cutters

**304. Development.**—It is not an original, neither is it a novel idea, for farmers to cut dry feed for their stock. This has been going on for ages. The first machine for cutting feed was simply a knife for hacking it up. Later the feed was placed in a box, allowing the ends to come over a cutter head; then a knife was drawn down over this head, which acted in the manner of shears. Possibly the next development in feed cutters was to fasten a spiral knife to a shaft in such a manner that the cutting might be done by a continuous rotary motion. Such a cutter was invented by Mr. Salmon of England in about 1820, and by a Mr. Eastman in the United States in 1822. Another type of machine which has been developed is one in which the knives are fastened to the spokes of a flywheel, and by which the feed is chopped by being fed into the wheel, the cutting taking place over the end of the feeding board.

The storage of green and partially cured succulent crops in a silo of some form or other may be traced to the beginning of history, but it has been recently that silos have been made use of in America. In 1882 the United States Department of Agriculture could find only 99 farmers in this country who owned silos. A silo may be found on nearly every dairy farm to-day, and it is considered to be almost an essential. The silage cutter is

simply the adaptation of the cutter for dry feed to the cutting of green crops.

305. **Cutter heads.**—Two types of cutter heads are to be found upon the market, which differ in the shape of

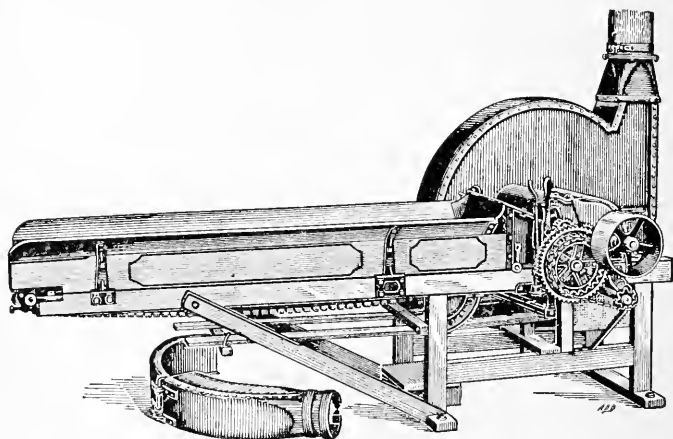

FIG. 167—AN ENSILAGE CUTTER WITH SELF-FEEDER AND PNEUMATIC ELEVATOR

knives used and the direction in which the fodder is fed to them. The **radial knife** is fastened directly to a flywheel,

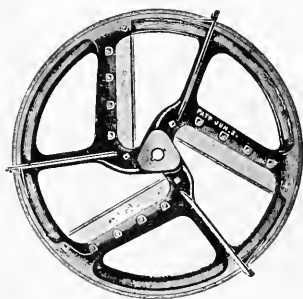

FIG. 168—A RADIAL KNIFE CUTTER HEAD

which may also carry the fan blades for the stacker. The advantage of this type lies in the fact that it has plenty of clearance and the chopped fodder does not have any difficulty in getting away from the cutting head. The knives are usually set at an angle to give a "shear cut." To this same head short knives or

teeth called splitters may be attached to split the ends of the stalk before they are cut off.

The second type of cutter head is the one which carries a **spiral knife**. The cutting edge is always the same distance from the shaft (Fig. 169). The knife may be provided with saw teeth for handling dry feed to better advantage.

306. The feeding table is provided on the larger power machines with an endless apron to carry the fodder to the feed rolls. The speed of the feed rolls and the apron is capable of adjustment for various rates of feed and coarseness of cutting.

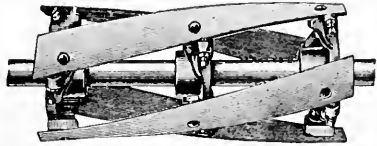

FIG. 169—A SPIRAL KNIFE CUTTER HEAD

307. **Elevators** are of two general types: double-chain conveyor or **web-carrier elevator**, and the **pneumatic**. The carrier elevator is satisfactory except for very high lifts. The long webs are a source of trouble. It is economical to build silos high; hence the use of pneumatic or wind elevators. It is necessary to keep the elevator pipe almost perpendicular, or the silage will settle to one side and not be carried up by the air blast.

308. **Selection.**—All bearings, especially those connected with the cutting knives and feed rollers, should be very long. The shaft should be strong, and the gears heavy enough to stand a variable load. It is well to have the feed rollers so arranged that should more feed go in one side than on the other, that side could expand, yet grip the feed firmly. Since the cutter head should have a capacity of from 600 to 1,000 revolutions a minute, the frame should be made exceptionally strong and stiff. Provision should be made so the bearings cannot wind, as this causes much more friction and thus will require

much more power than necessary. The capacity of silage cutters depends upon the length of each cut and upon the length of the knives, as well as the condition of the feed. In general a silage cutter should have a capacity of about one ton an hour for each horse power of power used.

### HUSKERS AND SHREDDERS

**309. Construction.**—The husker and shredder is a combined machine to convert the coarse corn fodder, stalk and leaves, into an inviting feed for farm animals, and at the same time deliver the corn nicely husked to the bin or the wagon. By this means the entire corn crop is made use of and the fodder put into better shape for feeding.

The usual arrangement of the husker and shredder is illustrated in Fig. 170. The fodder is first placed upon

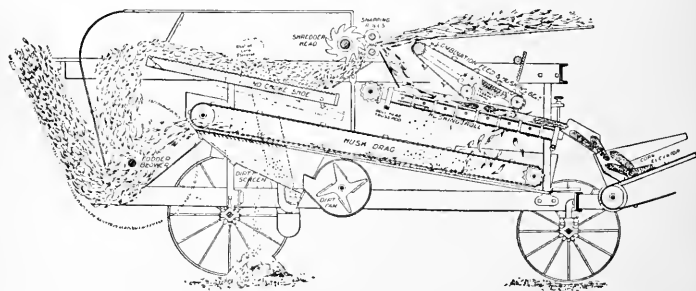

FIG. 170—SECTIONAL VIEW OF A HUSKER AND SHREDDER

the **feeding table**, from which it is fed, the butts first, to the feed or snapping rolls. Many of the machines are manufactured with self-feeders much like those for the threshing machine. Owing to the loss of hands and arms in feeding the early machines, provision is now

made whereby it will be almost impossible for accidents of this nature to happen.

As the stalks pass through the snapping rolls the ears are squeezed off and allowed to fall upon a conveyor, which carries them to the husking rolls, or they may fall upon the husking rolls direct. Here the husks are pulled off and are carried to the wagon or bin. When the stalks leave the snapping rolls they pass over cutting plates and immediately are cut into small particles by the shredding head. This shredded fodder is then conveyed to the elevator, which may be either a carrier or pneumatic stacker. As the shredded fodder passes through the machine it passes over beaters, which agitate the fodder so that all shelled corn falls out and is conveyed to the wagon.

**310. The snapping rolls.**—The snapping rolls of the shredder may either be made corrugated, chilled, casting, or, in better machines, of tool steel, or they may be made of cast iron and with lugs inserted. The latter type seems to be well adapted to green and damp corn. The snapping rolls are given sufficient pressure by springs to grasp the stalks firmly.

**311. The husking rolls** rotate together in pairs, grasping the husk and tearing it away from the ears. There are very many different types of husking rolls on the market. The most common type seems to be one where the rolls are set parallel to each other in pairs. The ends of the rolls where the ear first strikes are higher than the ends where the ear leaves. Sometimes there is an apron above which forces the ears along the rolls. The devices for catching the husks are simply lugs or husking pins set in the rolls. These lugs have sharp-tempered heads. The husking rolls are held firmly together by strong springs.

**312. The shredder head** may be made up of several plates of steel of the rip-saw type tooth. These plates are so warped or bent that for every revolution of the head only two teeth should pass over the same point in the stock. The teeth should be offset enough to cut off a fairly good slice. In some shredders there are no **cutting plates**. The shredder head is set so close to the snapping rolls that as the stalks come through it tears them to pieces. Some machines are also provided with a revolving cutter bar.

Many machines have an interchangeable shredder and cutter head. By using the cutter head the same machine may be used in cutting straw or green fodder silage. The shredder head is also made for some machines much like a thresher cylinder, except the teeth are shorter and sharper.

**313. Shelled corn separating device.**—One of the essential features of a shredder is to be able to separate all shelled corn from the shredded fodder. The best means for this is to have some form of beater agitating the shredded product in the air, and thereby allowing the shelled corn to rattle through. The corn then falls through a sieve and is conveyed to a bagger or wagon elevator.

**314. Size.**—The size of the husker and shredder is usually denoted by the number of husking rolls, as a 4-, 8-, or 10-roll machine.

**315. Capacity.**—The capacity of a husker and shredder is a variable quantity, as all manufacturers will state. It is somewhat difficult to reach a definite basis upon which to rate capacity. The number of acres a day or the number of bushels a day will not state accurately the amount of work performed. In general it may be safe to state



that the 8-roll husker and shredder will handle the fodder from 8 to 15 acres a day and husk from 25 to 80 bushels of corn an hour.

### CORN SHELLERS

**316. Development.**—The earliest device used in the shelling of Indian corn or maize was a simple iron bar placed across a box and over which the ear of corn was rasped. The edge of a shovel was often used in place of this bar. Another early scheme was to drive the ear with a mallet through a hole just large enough to let the cob pass through.

Edmund Burke, Commissioner of Patents, in making his report for the year 1848, states that two patents were granted on corn shellers. He also states: "Corn shellers have usually been constructed in one of three modes. In the first the shelling is performed on the periphery of a cylinder; in the second it is done on the sides (one or both) of a wheel; and in the third it is done by forcing, by means of a mallet or hammer, the cob, surrounded by the corn, through a hole sufficiently large to admit the cob only. The sides of this hole are called the strippers and are often arranged in radial sectional pieces of four, six, or eight each, acting concentrically against the corn or cob by the force of a spring or substitute behind.

"To this last kind of corn sheller there have been raised several objections, the most prominent of which is that in the opening of the radial sections by stripping the corn from the cob the kernels often become entangled and wedged between the radial sections and prevent some one or more of the sectional pieces from acting upon the rows of corn to which it may be opposite."

Among the early American inventors, Clinton and Burrall are the best known. The Burrall sheller was probably most popular. It was made of iron, furnished with a flywheel to equalize velocity, and was worked by one person while another fed it. It discharged the corn at the bottom and the cob at the end. Allen Wayne was the first man to make a two-hole sheller.

**317. Types of the modern sheller.**—There are two general types of corn sheller to-day outside of the ware-

house sheller, which will not be considered here. Only portable shellers will be discussed. One will be called the spring sheller, and the other is the well-known cylinder sheller.

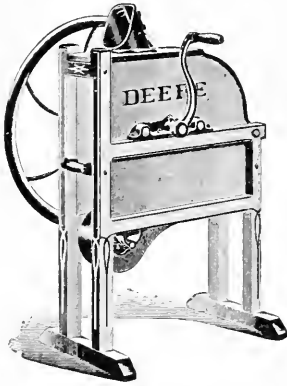

FIG. 171—A ONE-HOLE HAND SHELLER

318. The spring sheller.—This term may not be generally accepted, although it is a name applied by several manufacturers to the sheller whose shelling mechanism consists in picker wheels, bevel runners, and rag irons, held in place with springs. This type of sheller is illustrated in Fig. 172. It is also called the "picker" type of sheller. The parts mentioned which come in contact with the corn

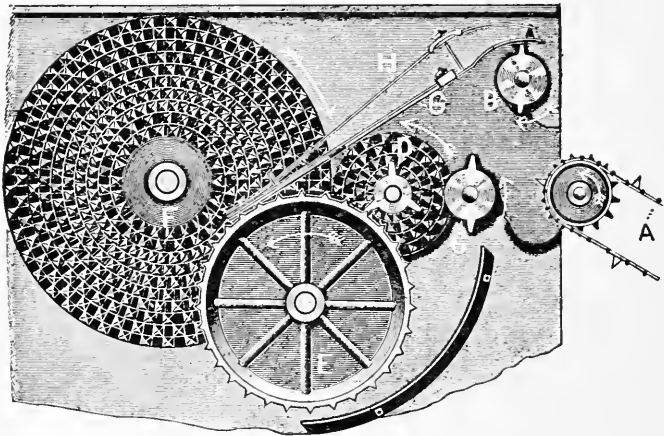

FIG. 172—SHELLING MECHANISM OF THE PICKER OR SPRING SHELLER.  
 A, FEED CHAIN; B, C, BEATERS; D, F, PICKER WHEELS;  
 E, BEVEL RUNNER; G, RAG IRON; H, SPRING

are made of chilled iron and are very hard. The tension on the rag-iron springs may be adjusted and should be capable of individual adjustment when necessary. The most important advantage of the spring sheller is that it leaves a whole cob. It is especially desirable to have whole cobs where they are used for fuel.

**319. The cylinder sheller.**—The shelling mechanism of the cylinder sheller is shown in Fig. 173, and is described by the manufacturer as follows: "The shelling cylinder is made of heavy rods of wrought iron placed equidistant,

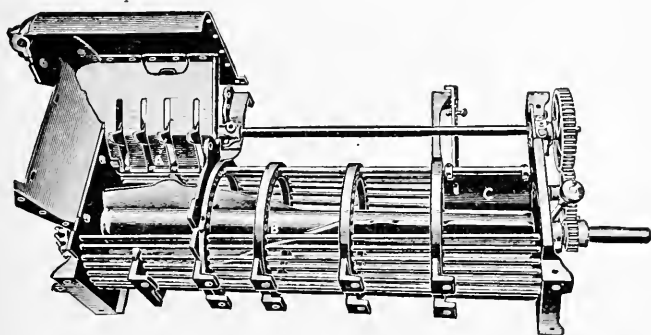

FIG. 173—SHELLING MECHANISM OF CYLINDER SHELLER

presenting a corrugated surface which cannot wear smooth. Within this a revolving iron cylinder with spiral vanes threshes the corn against the surfaces of the rod cylinder. The vanes approach the rods sufficiently close to keep every ear in rapid motion, shelling one ear or one bushel with the same facility. A regulator at the discharge end places the machine within control of the operator. The spaces between the rods allow the shelled corn to escape freely, thus lessening the draft, relieving the cylinder from clogging and from all liability to cut or

grind the grain." The cylinders are made adjustable to suit various sizes of corn.

320. **Self-feeder.**—The purpose of the self-feeder is to carry the ears to the shelling mechanism. The spring shellers are provided with feeder chains, which carry teeth to "end up" the ears and carry them directly to each set of shelling wheels, or to each "hole," as it is

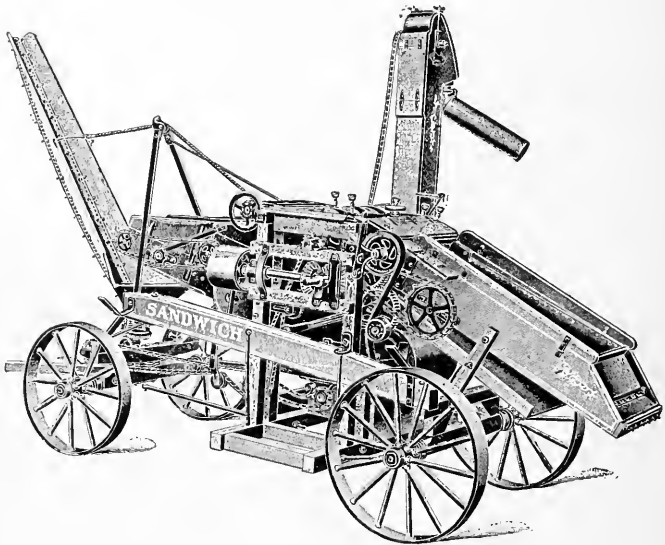

FIG. 174—A SIX-HOLE POWER SHELLER

called. The cylinder sheller uses a double chain conveyor with slats between, as it is not necessary to end up the ears. In all spring shellers provision must be made for forcing the ears into the holes. This is accomplished by adding picker-feeding wheels or a beater.

321. **Extension feeders.**—In shelling corn from large cribs, extension feeders are provided to circumvent the

carrying of the corn by hand. These are provided with double-chain conveyors and may be had in sections, making a "drag conveyor" which may be extended to almost any direction from the main feeder.

**322. Separating device.**—To separate the corn and the cobs, the whole, after passing through the shelling mechanism, is made to pass over a cob rack which permits the corn and chaff to pass through. The cob rack is made in at least three ways—a vibrating rack, a rod rack with rakes, or an endless rack with thumpers underneath. The latter two have advantage in lightness and amount of power required, and also in the steadiness by which the machine may be operated.

**323. Cleaning device.**—To clean the corn and free it from chaff and husks a fan is provided which sends its blast through some form of sieve or rack. The corn sieve may be dispensed with and a single rack used.

**324. Grain elevator.**—The grain on all portable machines is elevated by a chain cup elevator into the wagon box. To carry the corn to the lower end of the elevator an auger is universally used.

**325. Cob carrier.**—To carry the cobs from the sheller a single- or double-chain conveyor is used. It is an advantage to have this swing from the sheller.

**326. Dustless sheller.**—To carry the chaff and husks away from the sheller an auxiliary fan is provided on the larger machines to gather and discharge the dust and chaff at one point. A sheller so arranged is called a dustless sheller.

**327. Shuck sheller.**—A few of the spring shellers are arranged to handle partially husked corn, and many of the cylinder shellers are so arranged. The capacity of the machine is much reduced in handling snapped or unhusked corn.

**328. Power.**—The power required for a four-hole spring sheller is usually about eight horse. The six-hole machine requires about 10 and the eight-hole 12 to 14 horse power. The power required for cylinder shellers varies with the style and manufacturer's number.

**329. Capacity.**—The capacity of the spring sheller is determined by its size, which is denoted by the number of holes, which vary from the one-hole hand-power machine to the large eight-hole power sheller. A four-hole sheller is usually rated at 100 to 200 bushels an hour, the six-hole at 200 to 300, and the eight-hole at 300 to 600 bushels an hour. The size of the cylinder sheller is denoted by the manufacturer's number only. Cylinder shellers have a large capacity ranging up to 800 bushels an hour for the largest sizes.

**330. Selection of a sheller.**—The following are the requisites for a good portable corn sheller. First and probably the most important feature to look to is the frame. This should be made very strong. It should be mortised and tenoned and secured together by means of rods or bolts. The wood should be either of ash or oak. The bearings for all parts where there is considerable power placed upon them should be long, well secured to the frame, and, where possible, made dust proof. They should also be supplied with plugs or oil cups to keep all grit and dust from entering. The feeding shaft should be strong, and the lugs should be of chilled cast iron or cast steel. The feeder box should be supplied with agitators to prevent the corn piling up at the lower end and thus allowing the sheller to run partially empty. For large job work the machine should be provided with a drag carrier of length from about 10 to 20 feet. Where the cribs are extra long it is well to have two sections of about this length. The rag irons should be separate

as well as a combined adjustment. The sheller should be so constructed that it will not injure it to throw the feeder box and the feeder bar into operation while running. On either side of the sheller there should be an attachment for a grain elevator. The mechanism for receiving the power should be so constructed that the power, if necessary, can be applied upon either side. The cob carrier should be of the swing type with long enough lugs on the chain and velocity enough to convey the cobs away without allowing them to choke at the base. In the sheller there should be plenty of surface for the cobs to pass over so the corn can all separate from them.

In selecting a corn sheller and making the first trial, do not condemn the machine if it requires a large amount of power to run it. Possibly the fault is not in the sheller, but is in the condition of the corn. Corn which is green or damp requires very nearly, if not altogether, twice the power to shell it that dry corn requires.

## CHAPTER XII

### FEED MILLS

**331. Development.**—The mill was one of the first inventions of man. Feeding of cracked or broken grain to domestic animals has been practiced for many years; however, the practice did not become general until the introduction of the portable mill. The first mills were equipped with stone buhrs, but metallic plates were made use of at a very early date, for they have been mentioned in history. A description of a French mill using metallic buhrs is at hand which was used to grind grain for the soldiers in the army of Napoleon I.

**332. Buhrs and plates.**—The grinding depends largely upon the buhrs or plates. They are the parts which do the actual grinding; receiving the whole grain, they gradually reduce it to a meal.

The **stone buhr** is used to some extent to-day where a fine meal is desired. The meal from stone buhrs may be used for human food. Buhr stones must have a cellular structure to prevent them from taking on a polish and give them a better grip for grinding. The buhr stone must also be very tough. The best are imported and are known as French buhrs. Good buhr stones are quarried at Esopus, New York, and practically all of the buhr stones used in the United States come from this place. The buhr stone usually has a wrought-iron band shrunk over it to strengthen it. It must be sharpened with a chisel when worn, hence it is not popular for small farms.

**Metallic buhrs.**—Nearly all of the plates used on farm



mills or grinders are made of chilled iron, though tool steel and bronze are used to some extent.

**Chilled iron plates** or **buhrs** vary in shape, the usual form being two flat disks which are provided with ribs or corrugations to carry the grain to the outer edge between the milling surfaces (Fig. 175). The **cone buhr** is the result of an attempt to increase capacity by increasing the surface.

The **steel buhr** is made in the shape of a roller with a milled surface. The roller mills as used in flouring mills

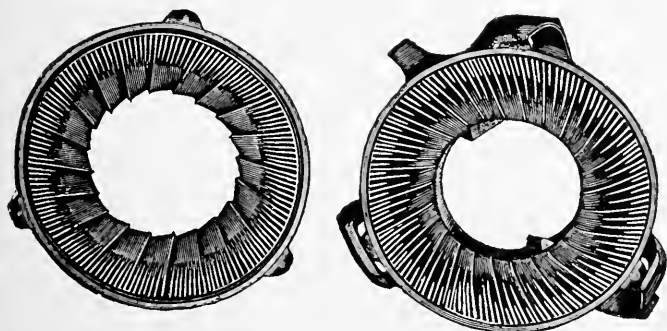

FIG. 175—CHILLED IRON BUHRS

are not used in preparing feed for stock to any extent. It is stated that the steel buhr has a large capacity, but will fill or clog when damp grain is being ground.

The **duplex buhr** has two grinding surfaces. The moving plate moves between two stationary plates (Fig. 178).

In order to grind ear corn a crusher is often provided to reduce the ears to pieces small enough to be fed to the buhrs. In sweep mills the crushing teeth are made a part of the main buhrs.

**333. Sweep mills.**—The simple sweep mill consists of two conical buhrs. The inner one remains stationary,

while the outer is rotated by a sweep. Nearly all sweep mills are arranged to grind ear corn. Fig. 177 illustrates a common type of the sweep mill. In order to increase

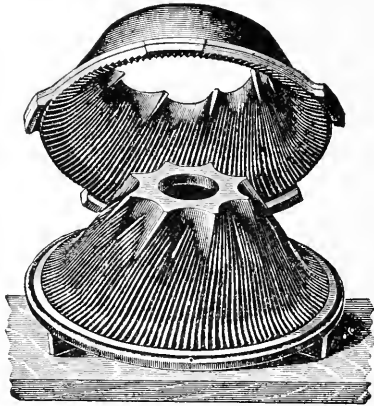

FIG. 176—BUHRS FOR A SWEEP MILL

the capacity of the mill one of the buhrs is geared up until it makes 3, or even 9 to 11, revolutions for each round of the team.

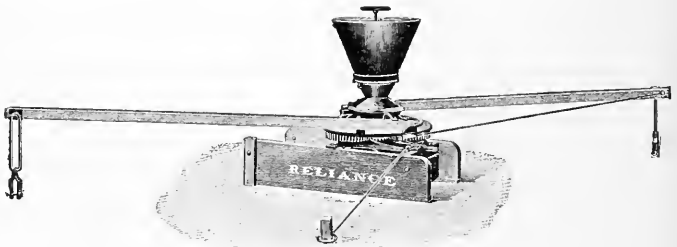

FIG. 177—A SWEEP MILL

334. The hitch.—The usual arrangement with the simple sweep mill is to hitch the team to the end of the single sweep. Some makers arrange to hitch the horses

**tandem**, the claim being that the work is more evenly divided between them, as they work upon an equalizer and each horse travels in the same circle.

With triple-gearred or higher-gearred sweep mills the capacity for grinding is so great that two horses are not sufficient to furnish the power; more horses must be added. The horses may be hitched in teams to sweeps opposite each other with an equalizer across or placed in tandem, as referred to.

**335. Combination mills**, or mills in combination with a small sweep power, are manufactured to enable the owner to drive other machinery such as a corn sheller. Such a mill is confined to the geared sweep type.

### POWER MILLS

**336.** Power mills are operated by belt or tumbling rod. Following is a discussion of the important parts of power mills.

A **balance wheel** is sometimes placed upon a mill to prevent the mill from choking due to an extra demand for power which will occur at times. The balance wheel is considered a good thing to have on a mill.

**Divided hopper.**—It is often desired to grind at least two kinds of grain at a time. To accomplish this a divided hopper is provided.

**Safety device.**—It often occurs that some hard substance, as a nail or a nut, becomes mixed in the grain and is placed in the mill. The safety device is a wooden break pin or spring catch, which permits the buhrs to open without damaging the mill.

The **quick release** is for the same purpose as the safety device, but is operated by hand. By its use the machine may be prevented from clogging when heavily loaded for any reason.

337. **Sacking elevators.**—When desired, all larger machines may be obtained with a sacking elevator, provided with a divided spout, to which two sacks may be attached at a time. While one sack is filling, the other may be removed and an empty sack adjusted in its place.

338. **The selection of a feed mill.**—Feed mills for farm purposes should have their frames constructed of cast

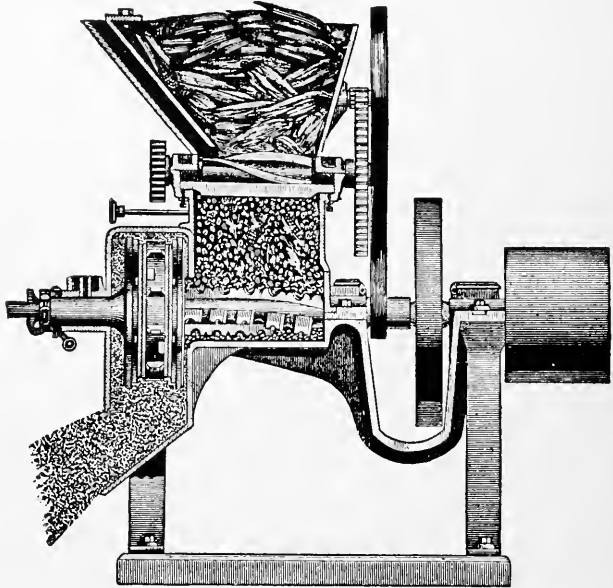

FIG. 178—A SECTIONAL VIEW OF A POWER MILL WITH DUPLEX BUHRS AND CRUSHING KNIVES

iron, in such a way that there is no binding in the bearings and all bearings may be well protected from the dust. The buhrs should have a device to release them when some foreign substance, such as stones, nails, nuts, etc., enters the mills. Besides this safety device there must be another which is handy and will regulate the

buhrs in a manner so they may be opened or closed according to the fineness to which the grain is to be ground. The buhrs should be attached to the shaft or mill in such a manner that they will not wobble and thus rub against each other under any condition whatever. This device should also be made substantial enough and accurate enough so the buhrs can be adjusted to almost any fineness and not interfere with each other. In a corn and cob grinder which is driven by a belt or tumbling rod, the hopper should be divided and should have a feed regulator so the ear corn and fine grain may be regulated as desired. There should also be a regulating device between the crushing cylinder and grinding buhrs. This is quite often effected by means of a lever and vibrating shutter, the former receiving its motion from the main shaft of the mill.

**339. Alfalfa mills** are used in reducing alfalfa hay to meal suitable for poultry and other stock. The mill has a cutter which cuts the hay into short lengths before passing to the buhrs. Alfalfa may be ground in the corn mill if the hay is passed through a hay cutter first. To grind successfully, alfalfa hay should be very dry. The capacity of alfalfa mills varies from 50 to 100 pounds of ground alfalfa an hour for each horse power used.

**340. Capacity of feed mills.**—The amount of feed ground an hour depends largely upon the degree of fineness of the ground meal and the condition of the grain as to moisture. It is to be expected that a mill with new sharp buhrs will have a much larger capacity than a mill with worn buhrs. Where a good quality of meal is produced a mill should be expected to grind at least four to five bushels of corn, or two to three bushels of oats an hour for each horse power used. Grinding ear corn the capacity will be one-third less.

341. **Corn crushers.**—It is within only the past three or four years that the value of crushed corn has become generally known to the cattle feeders. One principal reason for this is that in crushing corn the crushers may be so arranged that the husks may be chopped with the ear. By this means the feeder is enabled to give his cattle snapped corn which is broken or crushed fine enough so it is practically a coarse shelled corn mixed with ground cob and husks. One great advantage derived from such a scheme is that the crushing of the corn can be done very cheaply, it requiring only two or three horse power to crush 40 or 50 bushels an hour. Several feed grinders for grinding corn and cob are provided with a separate crusher and it is a question if this is not the most profitable means of grinding the corn and cob.

## CHAPTER XIII

### WAGONS, BUGGIES, AND SLEDS

**342. Development.**—Carts and wagons were used at a very early date, for in the Book of Genesis we find that when Pharaoh advanced Joseph to the second place, "he made him to ride in the second chariot he had." The chariot is only a form of cart. Later in Joseph's time we find that he sent wagons out of the land of Egypt to convey Jacob and his whole family to the land of his adoption. Not only did they have wagons and chariots at a very early date, but they were of similar construction to those of the present, for in the Book of Kings we read, "And the work of the wheels was like the work of a chariot wheel; their axletrees, and their naves, and their felloes, and their spokes were all molten." It is not known just when wheels were first bound with tires of iron, a practice which is of the greatest importance in the construction of the wheel. Wooden wheels without tires have been used in some countries until quite recently, and good authority states that they have a limited use to-day.

The use of carriages for general purposes began in the eighteenth century, though steel springs were introduced as early as the fourteenth. In 1804 Obadiah Elliott invented the elliptical spring. It was early in the nineteenth century that the greatest development took place. During this period Telford and Macadam were able to establish a system of good roads in England.

Carts for the hauling of loads are used to some extent in European countries and to a very limited extent in the

United States. Their use in the Middle West, however, is very rare. The general use of teams and the advantages of the wagon for larger loads are responsible for this.

## WAGONS

The essential features of a farm wagon are durability, convenience, lightness of weight and draft. These feat-

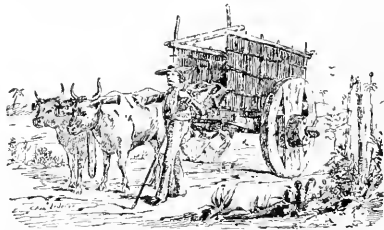

FIG. 179—A MEXICAN CART OF 1865. IMPORTED IN 1883 BY MESSRS. SCHUTTLE AND HUTZ OF CHICAGO, AND DONATED LATER TO THE SMITHSONIAN INSTITUTION, WASHINGTON, D. C.

ures depend upon the material, workmanship, and construction used in building the wagon.

343. **Material.**—Perhaps there is no service to which material may be placed which is as exacting and as severe

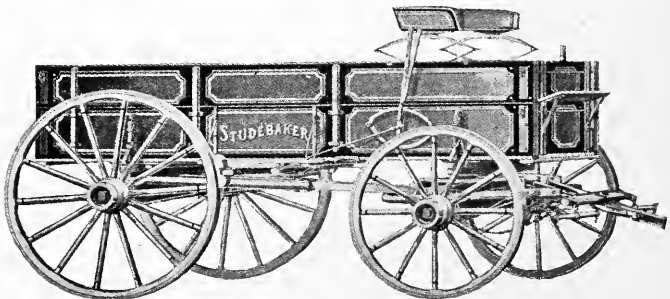

FIG. 180—A MODERN FARM WAGON WITH BOX BRAKE



as that required of material used in the construction of wagons and buggies. All wood should be carefully selected and thoroughly dried both in air and in kiln. Well-seasoned black birch is probably best for hubs; best-seasoned white oak for spokes, felloes, bolsters, sandboards, and hounds; hickory is preferable for axles,

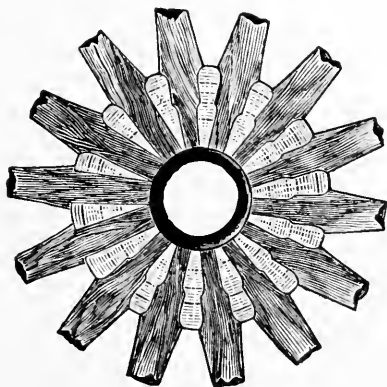

FIG. 181—A SECTION OF A WAGON HUB SHOWING THREE METHODS OF FORMING THE SPOKE SHOULDERS. THE ROUND SHOULDERS ARE SAID TO BE MUCH STRONGER AND MORE DURABLE

although the best straight-grained white oak is good. All metal parts should be of good Norway iron or mild steel.

**344. Wheels.**—All wooden wheels should be dished or the outer face of the wheel should present a concave surface. The dish in the wheel makes it much stronger, which may be illustrated with a paper disk and a paper cone. The cone is much stiffer. For front wheels this dish should be from  $\frac{3}{8}$  inch to  $\frac{5}{8}$  inch, and for rear wheels from  $\frac{1}{2}$  to  $\frac{3}{4}$  inch. At one time, wheels were given much more dish than at present. An English writer states that cart wheels should be dished as much as 3 inches. By giving the wheels an excessive amount

of dish, the cart bed may be made much wider. It does not matter greatly whether the felloes are bent or sawed, as the merits of the two methods are about equal. A rivet should be placed on the side of each spoke to prevent splitting. The felloes should be well doweled and the tire bolted to them. The standard height of wheels for a farm wagon with 3-inch skein or over is 3 feet 8 inches for the front wheels, and 4 feet 6 inches for the rear wheels. Smaller wagons have wheels of less

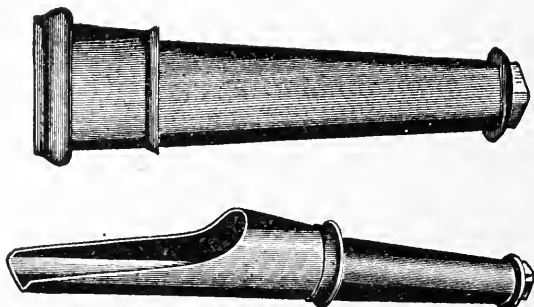

FIG. 182—THE UPPER IS THE CAST; THE LOWER, THE STEEL WAGON SKEIN

height. There is a tendency to use wheels of smaller diameter when wide tires are used. The thickness of the tire varies from  $\frac{1}{2}$  inch to  $\frac{3}{4}$  inch.

**345. The axles** should have as few holes in them as possible. Clips can nearly always be used instead of bolts excepting for the king bolt. A well-secured truss rod should be placed beneath each axle, and it is better if it is secured to the skeins.

The skein may be of either cast iron or steel. In level countries the former is preferable, while among the hills and mountains the latter with a long sleeve is probably more serviceable. Skeins should have a large throat to

take in all the wood possible, since this is the weakest point in the axle. They should gradually taper towards the nut so they can be forced on perfectly tight and not have to be bolted, as this weakens the axle.

**346. Gather.**—In setting the skeins the under side should be nearly parallel with the ground and the center of the nut end should be a trifle farther forward than the shoulder. The former is called **bottom gather** and the latter **front gather**. This is so that the wheel will not have a tendency to run towards the nut, to overcome the inclination of the dish of the wheel and keep the box rubbing against the collar of the skein. If the front edges of the felloes are  $\frac{1}{2}$  inch closer together than the back, it is sufficient.

**347. Tire setting** is possibly the most important part of wagon making, since the wheels invariably give out long before any other part. In purchasing a new wagon, it is difficult to tell whether the tires are properly set. However, always avoid buying wheels that have more or less dish than stated above. When having tires reset, see that the smith cuts enough out of the felloe to allow it to draw up snugly on to the spokes and force the spokes into the hub perfectly. Do not allow him to cut out so much that when the felloe is drawn together the wheel is dished more than stated above. Should he not cut out enough of the felloe to accomplish the tightness just stated the wheel will be known as felloe bound and it will be only a short time until the spokes will rattle in the rim or squeak at the hub.

**348. The reach** in itself is not such an important part, as any person can soon supply a new one. However, the way it is connected to the front axle and passes through the rear is very vital, since it will soon chafe in these places and eventually ruin the gears. See that there is

a plate on the under side of the sandboard and on top of the front axle, also see that there is a metal sleeve for the reach to pass through between the rear axle and bolster.

**349. Tongue, neckyoke and whiffletrees** are all essential, but not so important in their construction. They should all be made of the best selected oak except the doubletrees, which should be of hickory. Wherever there is any wear there should be metal plates or collars. It is well that the tongue be reënforced by an iron strip beneath and that the pole cap have an extra kink in front of the neckyoke lock to prevent the neckyoke from slipping off.

**350. Other parts.**—The same may be said of sandboards and bolsters as of axles. Between sandboard and bolster there should be a cup and cone plate with flanges which extend over the sides to prevent splitting. On top of each bolster there should be a plate of metal. The king bolt should have a large, flat head to prevent cutting into the bolster.

It does not matter so much as to the length and shape of the hounds, as it does to their bracing and fastening to the axles. Therefore see that they are well braced and so securely fastened that they will not work loose and soon wear at that point.

**351. Wide and narrow track.**—Two widths of tracks are in general use in the United States. The narrow track measures 4 feet 6 inches center to center of tires on the ground. The wide track is 5 feet measured in the same way. Although the use of each track is confined to certain sections, it results in much inconvenience at the borders of the districts where both styles are used. It is necessary to specify the width of track when purchasing a vehicle of any sort.

**352. The box.**—The wagon independent of the box is often spoken of as the gear. The box, or what is sometimes called the bed, may be removed and a hay rack or the gear may be used independently for the hauling of logs or lumber. The box of a narrow-track farm wagon is found to be the most convenient when it is 3 feet wide and 10 feet long inside, and made up of three sections, 14, 12, 10 inches deep. The second is spoken of as the top box and the third as the tiptop box. A box of the above dimensions will hold approximately two bushels for each inch in depth. A box of this size requires 3 feet 2 inches between the standards on the bolster, and is 10 feet 6 inches long outside. The sides of the box should be of the best selected yellow poplar and the bottom of 3-inch quarter-sawed yellow pine flooring with oak strips on the under side. A metal plate should be riveted on where the bolster rubs, and a rub iron of good design and secure attachment should be placed where the front wheel rubs. A device should be provided to hold the box sections securely together.

**353. Brakes.**—Wagon brakes are required in hilly localities. Two general types of wagon brakes are in use, the box brake or the brake attached to the wagon box, and the gear brake, attached to gear independent of the box, except that a lever attached to it is provided to be used when the box is used. The gear brake has two advantages in that it does not weaken or injure the box in any way, when used, and it may be used when the gear is used without the box. The box brake has a tendency to chatter and loosen the floor of the box.

**354. Painting.**—All of the wooden parts of the gears should be boiled in linseed oil and then one coat of paint applied before the ironing is done. The former process drives all moisture from the wood and fills the pores so

the paint adheres well; the latter keeps moisture from entering, thus preventing the wood from rotting under the iron. After ironing, two more coats of red lead paint should be added, then stripes, and finally a coat of wagon varnish. The box should be sandpapered, then painted with three coats of good pigment, after which it is striped and varnished.

**355. Capacity.**—As a wagon is subjected to shocks, it must be designed to carry many times any load which may be placed upon it. The following table is the average capacity of wagons as furnished by several manufacturers:

Wagons with Skeins		With Steel Axles	
Size of Skein	Capacity	Size of Axle	Capacity
$2\frac{1}{8}$	800	$1\frac{1}{16}$	600
$2\frac{1}{4}$	1,000	$1\frac{1}{8}$	800
$2\frac{3}{8}$	1,200	$1\frac{1}{4}$	1,200
$2\frac{1}{2}$	1,600	$1\frac{3}{8}$	1,600
$2\frac{3}{4}$	2,000	$1\frac{1}{2}$	2,250
3	3,000	$1\frac{5}{8}$	3,000
$3\frac{1}{4}$	4,000	$1\frac{3}{4}$	4,000
$3\frac{1}{2}$	5,500	2	5,000
$3\frac{3}{4}$	6,500	$2\frac{1}{4}$	6,500
4	8,500	$2\frac{1}{2}$	9,000
$4\frac{1}{4}$	10,000	3	15,000
$4\frac{1}{2}$	12,000		

**356. Draft of wagon.**—The draft of a wagon is the resistance encountered in moving the wagon with its load. It is often called tractive resistance, and is worthy of careful consideration, for a reduction in the draft of wagons not only means increased efficiency on the part of the draft animals, but also a reduction in the cost of transportation. The draft of wagons is made up of three elements: (a) axle friction, (b) rolling resistance, and (c) grade resistance.

357. **Axle friction** is the resistance of the wheel turning about its axle similar to the resistance of a journal turning in its bearing, independent of the other elements of draft. Axle friction is usually a small part of the total draft. The power required to overcome it diminishes as the ratio between the diameters of the wheel and axle increases. Thus in Fig. 183 if  $R$  be the radius of the wheel,  $r$  the radius of the axle, from the principle of the wheel and axle—

Power : Axle friction : :  $r$  :  $R$

$$\text{Power} = \frac{\text{Axle friction}}{R/r}$$

In the standard farm wagon  $R/r$  has a value of from 11 to 20, or an average of about 15.

Morin found in his experiments, which have been considered a standard for years, that with cast-iron axles in cast-iron bearings lubricated with lard, oil of olives or tallow gave a coefficient of friction of 0.07 to 0.08 when the lubrication was renewed in the usual way. Assuming 0.08 to be the coefficient of friction and 15 to be the ratio between wheel and axle diameters, the force re-

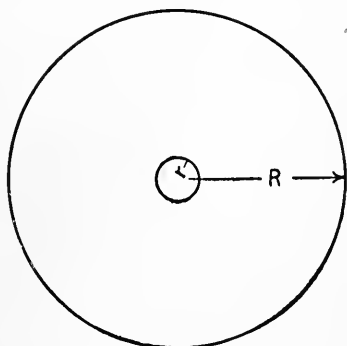

FIG. 183

quired per ton to overcome friction would be between 10 and 11 pounds. Another authority\* states that the tractive power required to overcome axle friction in a truck wagon which has medium-sized wheels and axles is about  $3\frac{1}{2}$  to  $4\frac{1}{2}$  pounds a ton. The use of ball and roller

\*I. O. Baker, "Roads and Pavements."

bearings would tend to reduce the axle friction and manufacturers trying to introduce these bearings claim a great reduction in draft. No doubt there are other advantages in the use of ball and roller bearings beside a reduction in draft. It is not thought that the dished wheel and bent axle are of a construction that tends to reduce axle friction to a minimum. It is hoped that experiments will be conducted at an early date to determine accurately the axle friction of wagons.

**358. Rolling resistance.**—Rolling resistance corresponds to rolling friction in that it is due to the indentation or cutting of the wheel into the road surface, which really causes the wheel to be rolling up an inclination or grade. The softer the road bed the farther the wheel will sink into it, and hence the steeper the inclination. The height of wheel influences the rolling resistance in that a wheel of large diameter will pass over an obstruction with less power, as the time in which the load is lifted is lengthened. There is also a less tendency upon the part of a large wheel to cut into the surface, due to the larger area presented at the bottom of the wheel to carry the load. Elaborate experiments have been conducted by T. I. Mairs, of the Missouri experiment station, in regard to the influence of height of wheel upon draft of wagons. Three sets of wheels were used with six-inch tires and a net load of 2,000 pounds was used in all cases. The total load for the high wheels was 3,762 pounds, for the medium wheels 3,580, and for the low wheels 3,362.

The high wheels were 44-inch front wheels and 56-inch hind wheels.

"	medium	"	"	36	"	"	"	"	40	"	"	"
"	low	"	"	24	"	"	"	"	28	"	"	"



## EFFECT OF HEIGHT OF WHEELS ON DRAFT \*

Draft in Pounds per Ton

Description of Road Surface	High Wheels	Medium Wheels	Low Wheels
Macadam; slightly worn, clean, fair condition.....	57	61	70
Dry gravel road; sand 1 inch deep, some loose stones.....	84	90	110
Earth road—dry and hard.....	69	75	99
“ “ —thawing ½-inch sticky mud.....	101	119	139
Timothy and bluegrass sod, dry, grass cut.....	132	145	179
“ “ “ wet and spongy....	173	203	281
Corn; field flat culture across rows, dry on top.....	178	201	265
Plowed ground, not harrowed dry and cloddy.....	252	303	374

The **width of tire** also influences the rolling resistance to a great extent. The wide tire on a soft road bed is able to carry the load to better advantage and prevent the wheel cutting in as far as it would otherwise.

The rolling resistance as indicated in the above remarks depends largely upon the condition of the road surface. The harder and smoother the road surface the less will be the rolling resistance. It is for this reason that much larger loads may be hauled upon good hard roads than upon poor soft ones. Prof. J. H. Waters, at the Missouri experiment station, has conducted extended experiments to determine the influence of the width of tire upon the draft of wagons when used on various road surfaces. The wheels used were of standard height and were provided with 1½-inch and 6-inch tires. The summary of the results of these experiments states that the wide tires gave a lighter draft except under the follow-

\* Missouri Agricultural Experiment Station, Bulletin No. 52, 1901.

ing conditions: (a) When the earth road was muddy, sloppy and sticky but firm underneath, (b) when the mud was deep and adhered to the wheels, (c) when the road was covered with deep loose dust, and (d) when the road was badly rutted with the narrow tire.

INFLUENCE OF WIDTH OF TIRE UPON DRAFT\*  
Draft in Pounds per Ton

Description of Road Surface	Width of Tire	
	1½-Inch	6-Inch
Broken stone road—hard, smooth, and no dust. . . . .	121	98
Gravel road—hard and smooth . . . . .	182	134
“ “ —wet, loose sand, 1 to 2½ inches deep. . . . .	246	254
Earth road loam, dry dust, 2 to 3 inches deep. . . . .	90	106
“ “ “ dry and hard, no dust. . . . .	149	109
“ “ “ stiff mud, dry on top, spongy underneath. . . . .	497	307
“ “ clay, sloppy mud, 3 to 4 inches hard below . . . . .	286	406
“ “ clay, stiff, deep mud. . . . .	825	551
Plowed land harrowed smooth and compact. . . . .	466	323

Besides the reduction of draft attained in the majority of cases with the use of wide tires, there is another important advantage from their use, as there is less tendency to rut and destroy the road surface. It is believed that this feature should be placed before all others.

There is a slight increase in draft with an increase in speed. Morin, who conducted experiments to determine the relation between draft and speed, found that the draft increased about as the fourth root of the speed. The draft upon starting a load is greater than after motion has been attained, and is due to the settling of the load into the road bed, the increased axle friction of rest, and

\* Missouri Agricultural Experiment Station, Bulletin No. 39, 1897.

the extra force required to accelerate the load. Springs tend to reduce draft, as they reduce the shocks and concussions due to the unevenness and irregularities of the road surface. Their effect is greater at high speeds than at lower.

**359. Grade resistance.**—Grade resistance involves the principle of the inclined plane, and may be explained as the force required to prevent the load from rolling down the slope. It is independent of everything except the angle of inclination.

In Fig. 184 if  $W$  be the load and  $P$  the grade resistance,  $AB$  the height of the grade and  $CB$  the length, by completing the force diagram similar triangles are obtained, from which it is seen :

$$P : AB :: W : AC, \text{ or } P = W \times \frac{AB}{AC}$$

As  $AC$  is very nearly equal to  $BC$  for ordinary grades, no great error will be accrued by substituting  $BC$  for  $AC$ . Grades are usually expressed in the number of feet rise and fall in 100 feet, or in the number of per cent the total rise is of the length of the grade. Then for practical purposes the grade resistance is equal to

the per cent of the total load, which expresses the grade. For example, if the grade is 5 per cent and the load 2,000 pounds, the grade resistance will be 100 pounds. The foregoing analysis does not take into account the way the load is placed on the wagon or angle of hitch, which may lead to error.

**360. Handy wagons.**—The name handy wagon is given to a low-wheeled, broad-tired wagon used about the farm for hauling implements, grain, and stock. They are used

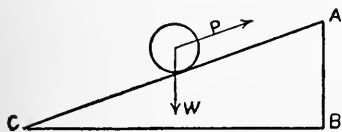

FIG. 184

to a limited extent in road transportation. Two styles of wheels are used, the metal with spokes cast in the hub and riveted into the tire, and a solid wooden wheel bound with a tire and provided with a cast hub.

The metal wheel may be had in any height from 24 inches up. The wheel with staggard oval spokes is considered stronger than the straight spoke wheel, as it is able to resist side hill stresses to better advantage.

The solid wooden wheel is very strong and there is no tendency for the wheel to fill with mud above the tire. The fact that the wheel proper is made of wood requires an occasional setting of tires, but this is not often, as the wheel is filled with circular wooden disks with the grain of the sections at right angles, and there is little shrinkage on account of the small diameter of the wheel. Four- or 5-inch tires are common widths used on handy wagons, although almost any width may be obtained.

Some handy wagons are made very cheaply and sold at a very low price. These wagons are poorly ironed, do not have any front or rear hounds, and are poorly finished. Others are made with as much care as the standard farm wagon and are as well finished. Care should be used in the selection of a handy wagon. Although boxes may be used upon handy wagons the wagon used about the farm is usually equipped with a rack or a flat top which readily permits the loading of implements, fodder, etc.

### BUGGIES AND CARRIAGES

**361. Selection.**—Light vehicles for driving have been in use since the introduction of springs and good roads. The points which make a buggy or a carriage popular are lightness, neatness of design, excellent and durable finish, good bracing, a reliable fifth wheel, well-secured

clips, and a body sufficiently braced and stayed and, if so provided, with a neat leather or at least leather quarter top. Leather quarter is the name given to tops made with leather sides above the curtains, while the roof is made of the cheaper material, rubber or oil cloth.

It is very hard to detect quality in a buggy and the reliability and guarantee of the manufacturer must be depended upon to a large extent. As in the construction of wagons and implements, poor quality may be detected by poor workmanship used in the construction. Only the best materials, carefully cured, should be used in the construction. The wheels and other wood parts of the

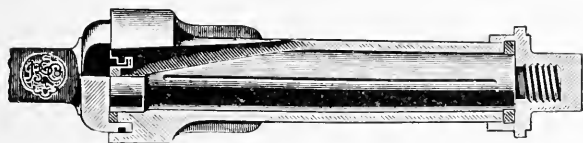

FIG. 185—A LONG-DISTANCE BUGGY AXLE. NOTE THE PROVISION MADE TO EXCLUDE DUST AND DIRT

gear should be made of best hickory. This is especially true of the wheels, which must meet with very hard service. The rims of the wheels should be well clipped and screwed.

362. **The body or box** should be made of the very best yellow poplar and should be well screwed and braced. The plain top buggy has two common styles of bodies: the **piano box**, which is narrow and has the same height of panel all around, and the **cornering body**, which has low panels just back of the **dashboard**.

363. **Hubs**.—Two styles of hubs are in general use, the **compressed** hub with staggard spokes and the **Sarven patent** hub. The former is perhaps the stronger but more difficult to repair.

There are many other parts which might be men-

tioned, as the styles of springs, spring bars, box loops, etc., but it is not deemed wise to take up space.

364. The painting of a buggy is of great importance and should be done only by an expert. Several coats of filler should be used, and between coats it should be

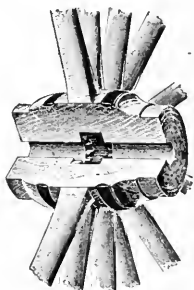

FIG. 186—A COMPRESSED  
WHEEL HUB

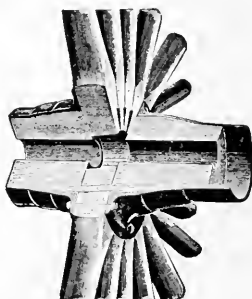

FIG. 187—A SARVEN  
WHEEL HUB

well sandpapered. In all, there should be 20 to 24 coats applied. It is stated that the varnish for the body should be first-grade copal, and for the gears second-grade copal, which should be very carefully rubbed between coats and the final coat should be rubbed with the palm of the hand.

### SLEDS

365. **Utility and selection.**—Sleds were the first means of conveyance known to man, and among the uncivilized they are still the only conveyance. There has probably been as great a change made in the sled as in the wagon since man commenced to improve his machinery.

Due to the variety of work required of sleds and the climatic conditions, there is almost invariably a different type of sled required in every locality. In heavily timbered countries where there is an extended season of snow, sleds are made with as much care as wagons, while

in communities where sleds are used only at intermittent times of the year and then only as a substitute for a wagon with light loads, they are very much more cheaply built.

Where the **runners** of a sled are bent they should be of either ash or hickory. If the natural curve of a tree is used, good hard wood will do. If the curve is sawed, white oak is better. All other parts should be of oak.

The **knees** should be fastened by means of two bolts on each end. This will prevent splitting. All connections are better if made flexible, and it is more convenient to have the front bob connected so it can turn under the load. The **shoes** are more economical when made of cast iron and removable. In communities where there is no continued season of snow a cheaper type of sled is sufficient. In such cases the shoes can be made of wrought iron, the bobs connected directly by a short reach and eyes, and the flexible parts dispensed with.

**366. Capacity.**—A bob sled with two knees in each bob ought to have a capacity of about 4,000 pounds, and one with three knees, of 6,000 pounds.

There is practically no limit to the load a team can handle on a sled provided they can start it. In most cases it is better to carry a bar to assist in starting the load and thus avoid the troublesome lead team.

In hilly countries it is essential to have some method for holding the load back in descending and to keep it standing while the team breathes upon ascending a hill. A short chain attached to the runner and dropped beneath it will hold the load back when descending a hill. In some localities a curved spike extending to the rear is bolted to the sled in such a manner as to prevent the sled from sliding backward when pressed to the snow by the teamster.

## CHAPTER XIV

### PUMPING MACHINERY

367. **Early methods of raising water.**—The oldest method of raising water was by bailing. The vessel and the water it contained were raised either by hand or by machines to which power might be applied. The buckets were provided with a handle or a rope when it was desired to draw water from some depth. To aid in drawing water from wells, the long sweep or lever weighted at one end was devised.

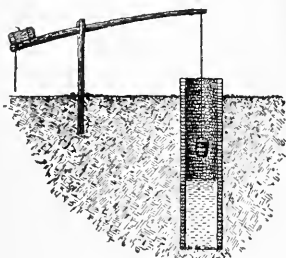

FIG. 188—THE WELL SWEEP  
AN OLD METHOD OF RAISING WATER

This sweep is often seen illustrated in pictures of an old homestead and similar pictures. Following the sweep, a rope over a pulley with two buckets, one at each end, was used. Later, one bucket was used and the rope carried over a guide pulley and wound around a drum. This latter method of raising has not entirely disappeared

and is still in use in many places.

For raising water short distances and in large quantities, swinging scoops and flash wheels are used. The scoop is provided with a handle and is swung by a cord long enough to permit it to be dipped into the water. The water is simply pitched to a higher elevation much like grain is elevated. Flash wheels are the reverse of the undershot water wheel; the paddles or blades ascending a chase or waterway carry the water along with



them. If operated by hand the paddles are hinged like valves and are rocked back and forth in the waterway. Flash wheels are used extensively in Holland in draining low lands.

The Chinese devised at a very early time scoop wheels which have buckets on the periphery. These buckets dip into water and are set at such an incline that they carry almost their full capacity to the upper side, and there they pour their contents into a trough. They are sometimes hinged and are made to discharge their contents by striking against a suitable guide. Wheels of this nature may now be used profitably where a large quantity of water is to be elevated for only short distances.

One of the oldest water-raising devices made famous by history is the Archimedean screw. It consists essentially of a tube wound spirally around an inclined shaft and taking part in the rotation of this shaft. The pitch of the screw and the inclination of the shaft are so chosen that a portion of each turn will always slope downward and form a pocket. A certain quantity of water will be carried up the screw in these pockets as it is rotated. At the upper end of the inclined screw the water is discharged from the open end of the tube.

**368. Reciprocating pumps.**—As advancement came along other lines of machinery, the early devices for raising water gave way to the introduction of more efficient machines to which may properly be given the name of pumps, the most common of which is the reciprocating pump. A reciprocating pump consists essentially of a cylinder and a closely fitting piston.

**369. Classes.**—Reciprocating pumps may be divided into two classes:

1. Pumps having solid pistons or plunger pumps.

## 2. Pumps having valves in the piston or bucket pumps.

Plunger pumps will not be considered in this discussion, for, at the present time, their use is confined almost entirely to steam and large power pumps. Pumps used for agricultural purposes are almost universally of the latter type.

Pumps may further be divided into two distinct classes:

1. Suction or lift pumps.
2. Force pumps.

Suction pumps do not elevate the water above the pump standard. The pump standard is the part which is above the well platform when speaking of pumps for hand or windmill power. A pump will then necessarily include the standard, cylinder, and pipes.

**370. Pump principles.**—Before continuing the discussion it will be well to take some of the principles connected with the action of pumps. The action of a plain suction pump when set in operation is to create a vacuum, and atmospheric pressure when the lower end of the suction pipe is immersed in water causes the vacuum to be filled. Atmospheric pressure amounts to about 14.7 pounds per square inch. Water gives a pressure of .434 pound per square inch for each foot of depth, or each foot of head, as it is usually spoken of. Thus atmospheric pressure will sustain a water column only about 33.9 feet, above which a vacuum will be formed. Pumps will not draw water satisfactorily by suction more than 25 feet, and it is much preferred to have the distance less than 20 feet. It is often an advantage to have the cylinder submerged.

**371. Hydraulic information.**—The following information will be useful in making calculations involving pumping machinery:

A United States gallon contains 231 cubic inches.

A cubic foot of water weighs 62.5 pounds.

A gallon of water weighs  $8\frac{1}{3}$  pounds.

A cubic foot contains approximately  $7\frac{1}{2}$  gallons.

The pressure of a column of water is equal to its height multiplied by .434. Approximately the pressure is equal to one-half of the height of water column or head.

Formulas for pump capacity and power:

D = diameter of pump cylinder in inches.

N = number of strokes per minute.

H = total height water is elevated, figuring from the surface of suction water to highest point of discharge.

S = length of stroke in inches.

Q = quantity of water in gallons raised per minute.

$D^2 \times .7854 \times S$  = capacity of pump in cubic inches per stroke.

$$\frac{D^2 \times S}{294} = \text{capacity of pump per stroke in gallons.}$$

$$\frac{D^2 \times S}{35.266} = \text{capacity of pump per stroke in pounds of water.}$$

$$\frac{D^2 \times S \times N}{294} = \text{capacity of pump per minute in gallons.}$$

$$\frac{D^2 \times S \times H \times N}{35.268} = \text{number of foot-pounds of work per minute.}$$

A rule which may be used to calculate roughly the capacity of a pump is as follows: The number of gallons pumped per minute by a pump with a 10-inch stroke at 30 strokes per minute is equal to the square of the diameter of the cylinder in inches. From this rule it is easy to calculate the capacity of a pump of a longer or shorter stroke and making more or less strokes per minute.

**372. Friction of pumps.**—Pumps used to pump water from wells are of rather low efficiency; on an average, 35 per cent of the power is required to overcome friction

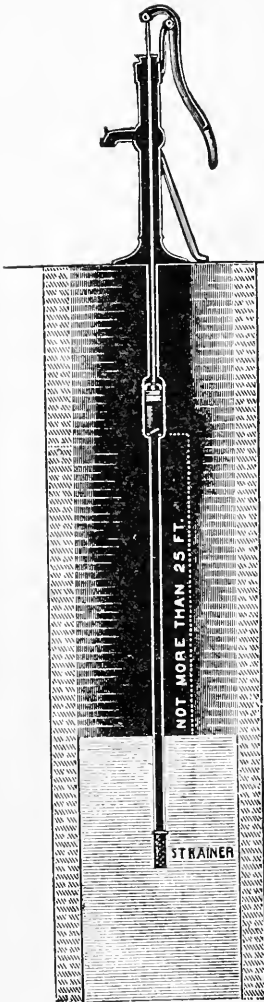

FIG. 189—A SUCTION PUMP IN A WELL

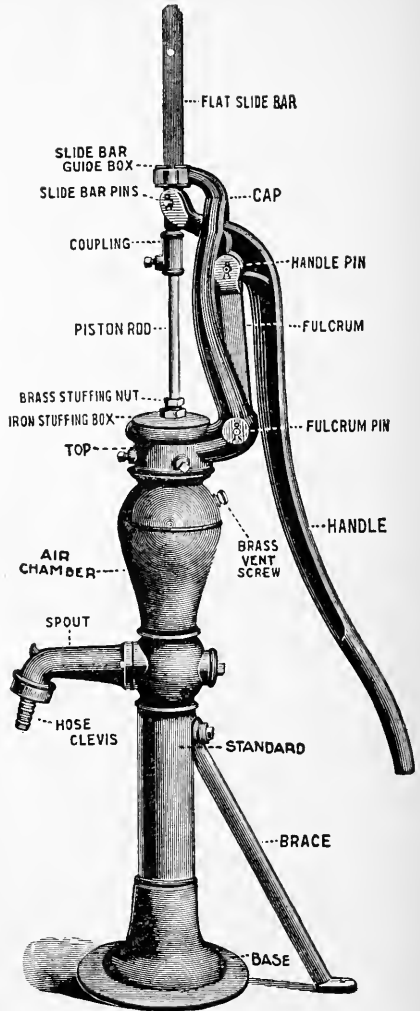

FIG. 190—A CAST-IRON PUMP STANDARD, WITH THE COMMON NAMES FOR ITS PARTS

alone. Often as much as one-half or even more of the power is required for this purpose. A common rule in use to determine approximately the power required to operate a farm pump is that one horse power is required to lift 30 gallons 100 feet per minute. From this rule it is easy to calculate for different capacities at more or less head. The rule assumes a mechanical efficiency of 68 per cent on the part of the pump.

The friction of water flowing in pipes is also very great. The loss of head due to friction is proportional to the length of the pipe and varies about as the square of the velocity of the flow. It is greatly increased by angles, valves, roughness, and obstructions in the pipe.

The following table given by Henry N. Ogden indicates the loss of head due to friction in pipes:

LOSS OF HEAD DUE TO FRICTION\*

Flow in Gallons per Minute	Loss of Head by Friction in each 100 Feet of Length	
	½-Inch Pipe	1-Inch Pipe
0.5	4	...
1.0	7	0.3
2.0	17	0.7
4.0	54	1.6
7.0	140	5.3
10.0	224	9.3

The importance of choosing a pipe of sufficient size for the flow per minute and the length of pipe is shown by this table. For instance, suppose it is desired to deliver seven gallons a minute at a distance of 500 feet. The ½-inch pipe would require an impractical head of

\* The Installation of Farm Water Supplies—Cyclopedia of American Agriculture, Vol. I., page 294.

700 feet, while 1-inch pipe would need only about 26 feet of head to secure the desired flow.

**373. Wells.**—The type of pump used will often depend upon the kind of well. Wells are divided into four classes: (a) dug or bored wells, (b) driven wells, (c) tubular wells, and (d) drilled wells. Dug wells are those from which the earth is removed by a bucket, rope, and windlass. These wells are either walled with stone or brick or cased with wooden or tile curbing. Bored wells belong to the same class except the earth is removed from the well with an auger. Pumps for dug or bored wells are independent of the casing, and any common type may be used provided the cylinder is placed within the proper distance of the water. Driven wells are made by attaching a point with a screened opening to permit of a flow of water to the casing, usually 1¼-inch galvanized pipe, and the whole driven to sand or gravel strata bearing water. A driven well does not extend through rock strata. Tubular wells are made by attaching a cutting edge to the well casing, which is usually made of pipe 2 inches in diameter, and which is sunk into the opening made by a drill which operates inside of the casing. The earth and chips of stone are removed by a stream of water which flows out through the hollow drill rod in the form of a thin mud. A screened sand point similar to those used in driven wells is placed in the bottom of the well after it has been finished. A turned flange is provided which prevents the point from passing beyond the casing. A pit 6 feet deep and 4 feet square, walled with brick, stone, or cement, should be placed around driven and tubular wells to permit of the use of underground pumps, or to provide a vent hole to prevent water freezing in the pump standard during cold weather. It is an advantage to have the well at least 6

inches from one side of the pit wall, as this will permit the use of pipe tools to better advantage.

Drilled wells are much like tubular wells except that they are larger, usually 6 or 8 inches in diameter, cased with wrought-iron pipe or galvanized-iron tubing. The pump is independent of the casing and may be removed without molesting it in any way.

Pump cylinders or barrels usually form a section of the casing in driven and tubular wells. The lower check valve is seated below the barrel by expanding a rubber bush against the walls of the well casing in such a way as to hold it firmly in place. It is to be noted that wooden pump rods should be used for deep-driven and tubular wells, for wooden rods may not only be lighter, but displace a large amount of water, reducing the weight on the pump rod during the up stroke.

**374. Wooden pumps.**—The first pumps were made of wood, simply bored out smoothly and fitted with a piston. The wood used was either oak, maple, or poplar. Later an iron cylinder was provided for the piston to work in. The better pumps of to-day belonging to this class have porcelain-lined or brass cylinders. These lined cylinders are smoother and are not acted upon by rust. Wooden pumps are nearly all lift pumps and can be used only in shallow wells. The cylinder is fitted in the lower end of the stock and no provision is made for lowering it. Wooden pumps are used with wooden piping, the ends of the pipe being driven into the lower end of the stock so as to form an air-tight joint.

**375. Lift pumps.**—Lift pumps include all pumps not made to elevate water above the pump standard. For this reason the top of the pump is made open and the pump rod not packed, as is the case in force pumps. Lift pumps, in the cheaper types, are cast in one piece, the

handle and top set in one direction, which cannot be changed. Another style of light pump is made in which the lower part of the standard is a piece of wrought-iron pipe. The cast standard has one advantage in cold climates, as it permits warm air from the well to circulate around the pipe where it extends into the standard and prevents freezing to a certain extent.

**376. Pump tops.**—Pump tops are divided into two classes, known as hand and windmill tops. The former permits the use of hand power only, while with the latter the pump rod is extended so as to permit windmill connection. At least two methods are to be found for fastening the pump top in place: set screws and offset bolts. The latter seem to give the best satisfaction, as they give more surface to support the top and are not apt to work loose from the jerky motion given to the pump handle. Windmill tops should be provided with interchangeable guides or bushes, which may be replaced when worn. This is not important, however, as very little wear comes upon the bushes, the forces being transmitted in a vertical direction only.

**377. Spouts.**—Spouts are either cast with the pump standard or made detachable. They are styled by the makers plain, siphon or gooseneck, and cock spouts. The object of the siphon spout seems to be the securing of a more even flow of water from the pump. If the pump is a force pump, the spout should be provided with some means of making a hose connection. The cock spout is for this purpose, but a yoke hose connection or clevis may be used for the same purpose with a disk of leather in the place of the regular washer.

**378. Bases.**—Like the spout, the base may be cast with the rest of the pump standard. However, there are two other types found upon the market: the adjustable and



split or ornamental. It is a great advantage in fitting the standard to a driven well to have the base adjustable, doing away with the necessity of cutting the pipe an exact length in order to have the base rest upon the pump platform or having to build the platform to the pump base.

**379. Force pumps.**—Force pumps are those designed to force water against pressure or into an elevated tank. In order to do this the pump rod must be packed to make it air tight. Force pumps are also provided with an air chamber to prevent shocks on the pump. It is common practice to use the upper part of the pump standard for the air chamber. It has a vent cock or a vent screw to permit the introduction of air when the pump becomes waterlogged. With tubular wells it is an advantage to have a pump standard with a large opening its entire length and a removable cap to permit the withdrawal of the plunger or cylinder. The two most common methods of providing for this are to have the pump caps screwed on and to have the cap and the pump top in one piece. In the latter case the entire top is made air tight by drawing it down on a leather gasket or washer on the top of the standard.

**380. Double-pipe pumps or underground force pumps.** This class of pump is used where the water is to be forced underground, away from the pump to some tank or reservoir. These pumps are built with either a hand or a windmill top. A two-way cock is provided, manipulated from the platform to send the water either out of the spout above the platform or through the underground pipe. As the piston rod of these pumps has to be packed below the platform where it is not of free access, we find in use a method of packing known as the stuffing-box tube to take the place of the ordinary brass bush.

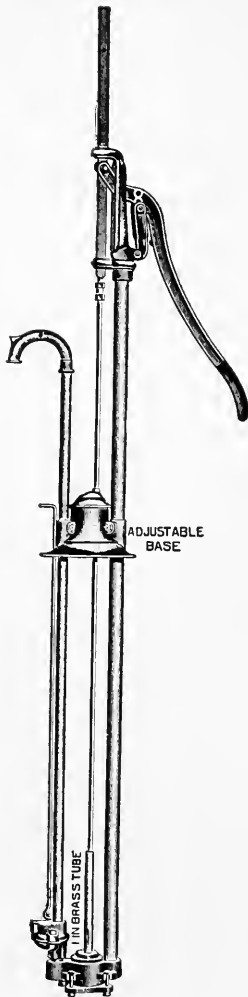

FIG. 191—A DOUBLE PIPE OR UNDERGROUND PUMP WITH STUFFING-BOX TUBE AND ADJUSTABLE BASE

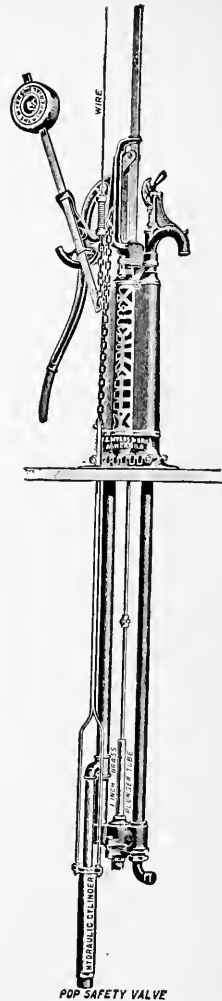

FIG. 192—AN UNDERGROUND PUMP WITH ORNAMENTAL BASE AND EQUIPPED WITH A WINDMILL REGULATOR

The stuffing-box tube is nothing more nor less than an auxiliary piston fitted with the regular leathers. The tube is always made of brass, and does not need attention as often as the regular stuffing box.

**381. Pump cylinders.**—Three classes of pump cylinders are found upon the market: Iron, brass-lined, and brass-body. Iron cylinders are used mostly in shallow wells. Brass-lined and brass-body cylinders are the most desirable, as they work very smoothly and will not corrode in the least. Iron cylinders are often galvanized to prevent rusting. Brass-body cylinders have the cylindrical portion between the caps made entirely of brass. Brass cylinders are easily damaged by being dented, and when so damaged cannot be repaired to good advantage. Brass being a soft metal, some difficulty is encountered in making a good connection between the cylinder and the caps by screw threads. In order to strengthen the brass-body cylinder at this point, the caps are often fitted on the cylinder by rods at the sides.

Cylinders to be used inside of tubular or drilled wells are made with flush caps to enable a larger cylinder to be put into the well.

**382. Valves.**—The valves of a pump are a very vital part. Most valves are made of iron in the piston and leather in the cylinder cap. Brass often makes a better valve than iron, as it will not corrode. The valve commonly used is known as a poppet valve, and may have one or three prongs. The single-pronged valve is not interfered with by sand to the same extent as the three-pronged. Ball valves are used in deep-well pumps, but it is very difficult to keep these valves tight. Various materials are used out of which to make the valve seats. One large manufacturer manufactures valve seats of glass and makes many claims for their superiority.

Pump pistons are usually provided with only one cap leather for the piston. For high pressures more are needed, and in the better makes of deep-well pumps the pistons are provided with three or even four leathers.

**383. Pump regulators** have a hydraulic cylinder attached, into which the pump forces water when the connection with the tank is cut off by a float valve. The hydraulic cylinder is provided with a piston and a stuffing box and a piston rod. Connection is made by a chain to a quadrant on a weighted lever above the platform. This lever is also attached to the pull-out wire of the mill. All the water being forced into the hydraulic cylinder, enough pressure is created to pull the mill out of gear. Safety valves are provided to prevent too great pressures coming on the hydraulic cylinder, which might cause breakage.

**384. Chain and bucket pumps.**—Chain pumps have the pistons or buckets attached to a chain running over a sprocket wheel at the upper or crank end, and dip in the water at the lower. The buckets are drawn up through a tube, into which they fit and carry along with them the water from the well. The chain pump is suited only for low lifts.

Another type of pump similar to the above and sometimes styled a water elevator has buckets open at one end, attached to the chain. These are filled at the bottom and are carried to the top, where they are emptied. It is claimed the buckets carry air into the water and this has a beneficial effect.

**385. Power pumps** are not used very extensively about the farm except for irrigation and drainage purposes. When the power is applied with a belt the pump is known as a belted pump. If provided with two cylinders, it is known as duplex; if three, triplex. The cylinders may

be single or double acting. In double-acting pumps the water is discharged at each forward and backward stroke. The capacity of a double-acting pump is twice that of a single-acting pump. A direct-connected pump is on the same shaft with the motor or engine, or coupled thereto.

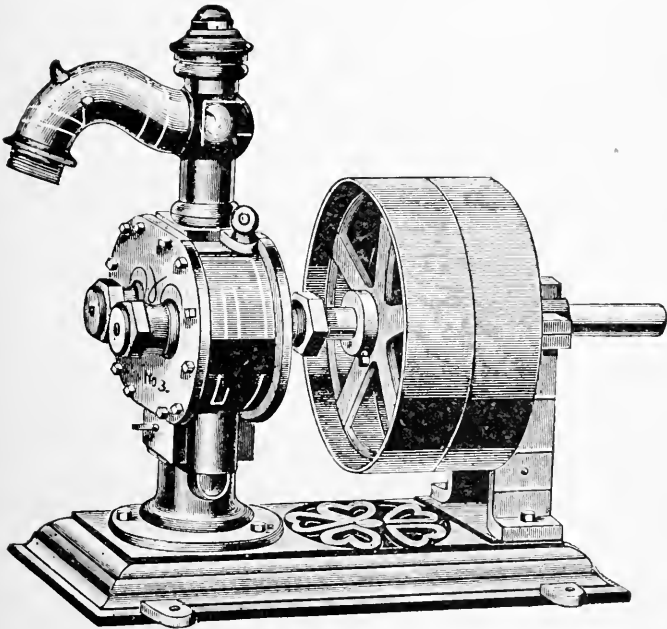

FIG. 193—A ROTARY PUMP

386. Rotary pumps are used to some extent in pumping about the farm. They are not suited for high lifts, as there is too much slippage of the water past the pistons. They are not very durable, and it is doubtful if they will ever come into extensive use.

387. Centrifugal pumps are used where a large quan-

tity of water is to be moved through a short lift, as in drainage and irrigation work. They are efficient machines

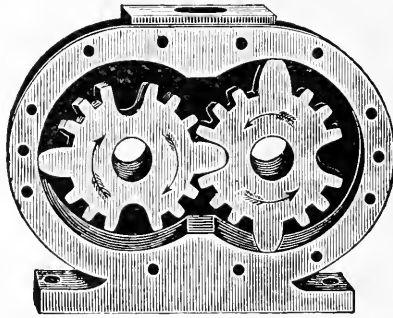

FIG. 194—SECTION OF A ROTARY PUMP SHOWING PISTONS

for low lifts at least, and will handle dirty water better than any other kind of pump. Centrifugal pumps are

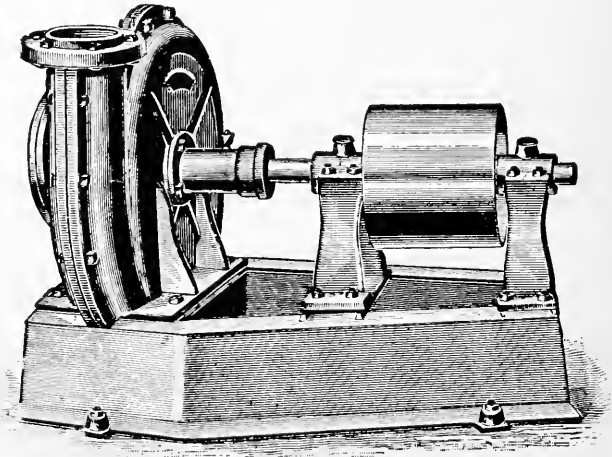

FIG. 195—CENTRIFUGAL PUMP

made with either a vertical or a horizontal shaft. The pumps with a vertical shaft are called vertical pumps and

may be placed in wells of small diameter. This class of pump gives but little suction and works the best when immersed in the water.

**388. The hydraulic ram.**—Where a fall of water of sufficient head and volume is at hand, it may be used to elevate a portion of the flow of water to a higher elevation. The action of a hydraulic ram depends upon the intermittent flow of a stream of water whose momentum when brought to rest is used in forcing a smaller stream to higher elevation. The ram consists essentially of (a) a drive pipe leading the water from an elevated source to the ram; (b) a valve which automatically shuts off the flow of water from the drive pipe through the overflow, after sufficient momentum has been gathered by the water; (c) an air chamber in which air is compressed by the moving water in the drive pipe in coming to rest; and (d) a discharge pipe of smaller diameter leading to the elevated reservoir.

TABLE OF PROPORTIONATE HEAD, GIVING HIGHEST EFFICIENCY IN OPERATION OF HYDRAULIC RAM\*

To Deliver Water to Height of	Place Ram under	Conducted Through
20 feet above ram	3 feet Head of Fall	30 feet of Drive Pipe
40 " " "	5 " " "	40 " " "
80 " " "	10 " " "	80 " " "
120 " " "	17 " " "	125 " " "

Under the foregoing conditions about 12 times as much water will be required to operate ram as will be discharged.

Hydraulic rams are manufactured in sizes to discharge from 1 to 60 gallons a minute, and for larger capacities

\* The Gould Company, Chicago.

rams may be used in batteries. To replenish the air in the air chamber, a snifting valve is placed on the drive pipe. In freezing weather it is necessary to protect the ram by housing, and often artificial heat must be supplied.

**389. Water storage.**—Owing to the fact that water must in nearly all cases be pumped at certain times which

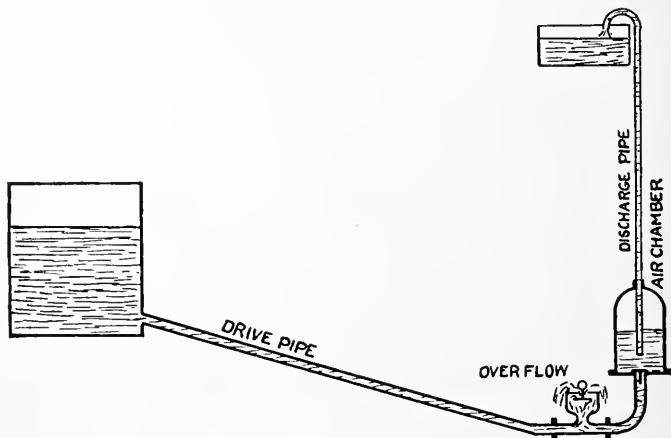

FIG. 196—HYDRAULIC RAM IN OUTLINE

may vary greatly in the intervals between each other, some form of water storage must be had in order to secure at all times an adequate supply to meet the constant needs. It is not only necessary to have a supply to furnish water for stock and household needs, but also for fire protection.

**390. Amount of water needed.**—The amount of water required for household purposes with modern conveniences has been found to be about 20 gallons a person, large or small. A horse will drink about 7 gallons a day and a cow 5 to 6 gallons. From this data the amount of water used a day may be estimated. If a windmill is



used to pump the water, three to four days' supply should be stored to provide for a calm. If a gasoline engine is used, it will not be necessary to store for so long an interval. Two systems of storing water are now in use: the elevated tank and the pneumatic tank.

**391. Storage tanks.**—*The elevated tank* may be placed outside on a tower, or in the building upon an upper floor. The objection to placing a tank in a building is the great weight to be supported. It has the advantage of being protected from dirt and the weather. The elevated tank on a tower is exposed to freezing in winter and to the heat of the sun in summer. Furthermore, a tower and a wooden tank are not very durable. The elevated tank is cheaper than the pneumatic system where a large amount of storage is desired. A reservoir located on a natural prominence, when such a location can be secured, offers many advantages in the way of capacity and cheapness.

*The pneumatic or air-pressure system* has an inclosed tank partly filled with air and partly with water. When filled the air is under pressure, and, being elastic, will give the same kind of pressure to the water as an elevated tank. One of the principal advantages of the air-pressure system is that the tank may be buried in the ground or placed in the cellar in a cool place. The disadvantage is a limited capacity for the cost.

If water be pumped into a closed tank until the tank is half full, the air contained will give a pressure of about 15 pounds a square inch, which is sufficient to force the water to a height of 33 feet. Air in the tank follows the well-known law of gases known as Boyle's law— $\text{pressure} \times \text{volume} = \text{constant}$ . If the air be pumped to a pressure of 10 pounds before the introduction of the water, the maximum discharge from the tank will be had at the

common working pressures. The water capacity of a tank will not be more in any case than two-thirds the total capacity of the tank. As the water continually dissolves a certain amount of the air, or, rather, carries the air out with it, it is necessary to supply air to the tank from time to time. Pumps are now arranged with an auxiliary air cylinder to supply this air.

It is not advisable to pump air to pressure because it is very slow work, as each cylinderful must be compressed before any is forced into the tank.

Air-pressure tanks must be very carefully made, as air is very hard to contain, much more difficult than steam.

## CHAPTER XV

### THE VALUE AND CARE OF FARM MACHINERY

**392. Value and cost.**—Few realize the enormous sums spent annually by the farmers of the United States for machinery. Of the \$2,910,138,663, the value of all crops raised in 1899, about 3.4 per cent was spent for machinery. The total amount of money invested in machinery was \$749,775,970. The following is the census report of the value of machinery manufactured each census year since 1850:

Year	Total for U. S.	Year	Total for U. S.
1850.....	\$6,842,611	1880.....	\$68,640,486
1860.....	20,831,904	1890.....	81,271,651
1870.....	42,653,500	1900.....	101,207,428

In closing, it is fitting that the subject of the care of farm machinery be considered, for one reason at least. The American farmers buy each year over \$100,000,000 worth of machinery, which is known to be used less efficiently than it should be. The fact that farm machinery is poorly housed may be noticed on every hand. Even the casual observer will agree that if machines were housed and kept in a better state of repair they would last much longer and do more efficient work. It has been stated by conservative men that the average life of the modern binder is less than one-half what it should be.

The care of farm machinery readily divides itself into three heads: First, housing or protecting from the weather; second, repairing; third, painting.

**393. Housing.**—Many instances are on record where farmers have kept their tools in constant use by good care for more than twice the average life of the machine. The machinery needed to operate the modern farm represents a large investment on the part of the farmer. This should be considered as capital invested and made to realize as large a dividend as possible. The following is a list of the field tools needed on the average 160-acre farm and their approximate value:

1 grain binder.....	\$125.00
1 mower.....	45.00
1 gang plow.....	65.00
1 walking plow.....	14.00
1 riding cultivator.....	26.00
1 walking cultivator.....	16.00
1 disk harrow.....	30.00
1 smoothing harrow.....	17.00
2 farm wagons.....	150.00
1 corn planter.....	42.00
1 seeder.....	28.00
1 manure spreader.....	130.00
1 hay loader.....	65.00
1 hay rake.....	26.00
1 light road wagon.....	60.00
1 buggy.....	85.00
	<hr/>
Total.....	\$924.00

In addition to the above, miscellaneous equipment will be needed which will make the total over \$1,000. If not protected from the weather; this equipment would not do good work for more than five years. If well housed, every tool ought to last 12 years or longer. It is obvious that a great saving will accrue by the housing of the implements. An implement house which will house these implements can be built for approximately \$200, and it is

to be seen that it would prove to be a very good investment.

Sentiment ought to be such that the man who does not take good care of his machinery will be placed in the same class as the man who does not take good care of his live stock.

**394. Repairing.**—Repairs should be made systematically, and, as far as possible, at times when work is not rushing. It is necessary to have some system in looking after the machines in order that when a machine is to be used it will be ready and in good repair. In putting a machine away after a season's work, it is suggested that a note be made of the repairs needed. These notes may be written on tags and attached to the machine. During the winter the tool may be taken into the shop, with which every farm should be provided, and the machine put in first-class shape, ready to be used upon short notice. It is often an advantage not only in the choice of time, but also in being able to give the implement agent plenty of time in which to obtain the repairs. Often repairs, such as needed, will have to come from the factory, and plenty of time should be allowed.

**395. Painting.**—Nothing adds so much to the appearance of a vehicle or implement as the finish. An implement may be in a very good state of repair and still give anything but that impression, by the faded condition of its paint. Paint not only adds to the appearance, but also acts as a preservative to many of the parts, especially if they are made of wood.

As a rule, hand-mixed paints are the best, but there are good brands of ready-mixed paints upon the market, and they are more convenient to use than the colors mixed with oil. It is the practice in factories, where the pieces are not too large, to dip the entire piece in a paint vat.

After the color coat has dried, the piece is striped and dipped in the same way in the varnish. This system is very satisfactory when a good quality of paint is used. It is not possible here to give instructions in regard to painting. It might be mentioned, though, that the surface should in all cases be dry and clean before applying any paint.

# FARM MOTORS

## PART II

---

### INTRODUCTION

**396. Motors.**—The application of power to the work of the farm largely relieves the farmer from mere physical exertion, but demands of him more skill and mental activity. At the present time practically all work may be performed by machines operated by power other than man power. This change has been important in that it has increased the efficiency and capacity of one man's work. Farm Machinery has been a discussion of the machines requiring power to operate them, while Farm Motors will be a discussion of the machines furnishing the power. The number of machines requiring power to operate them is increasing very rapidly. They require the farmer to understand the operation and care of the various forms of motors used for agricultural purposes.

**397. Energy** may be defined as the power of producing change of any kind. It exists in two general forms:

1. Potential or stored energy, an example of which is the energy contained in unburned coal.
2. Kinetic or energy of motion, an example of which is the energy of a falling body.

**Sources of energy.**—Following are some of the sources of energy available for the production of power.

**Potential:**

1. Fuel.
2. Food.
3. Head of water.
4. Chemical forces.

**Kinetic or actual:**

1. Air in motion, or the wind.
2. The waterfall.
3. Tides.

The energy found in the forms just mentioned must be converted into a form in which it may be applied to machines for doing work. This change of the energy from one form to another is spoken of as the transformation of energy.

**The law of transformation of energy** holds that when a definite amount of energy disappears from one form a definite amount appears in the new form, or there is a quantivalence.

**Prime movers** are those machines which receive energy directly from natural sources and transmit it to other machines which are fitted for doing the various kinds of useful work.

**398. Forms of motors:**

1. The animal body.
2. Heat engines—  
    Air,  
    Gas or vapor,  
    Steam,  
    Solar.
3. Water wheels.
4. Tidal machines.
5. Windmills.
6. Electrical motors.

Of the above all are prime movers except the last named, the electrical motors. The energy for the animal



body is derived from the food eaten. This undergoes a chemical change during the process of digestion and assimilation, and is transformed into mechanical energy by a process not fully understood. Heat engines make use of the heat liberated by the chemical union of the combustible constituents of fuel and oxygen. Water wheels, tidal machines, and windmills utilize the kinetic energy of masses of moving water or air. Electrical motors depend either upon chemical action or a dynamo to furnish the energy, it being necessary to drive the latter with some form of prime mover.

Only such motors as are well adapted to agricultural purposes will be considered in this treatise.

## CHAPTER XVI

### ANIMAL MOTORS

399. **The animal as a motor.**—Although the animal differs from other forms of motors, being an animated thing, it is possible, however, to consider it as a machine in which energy in the form of food is transformed into mechanical energy, which may be applied to the operation of various machines. The animal as a motor is exceptionally interesting to those who have made a study of the transformation of heat energy into mechanical energy, for this is really what takes place. Combustible matter in the form of grain and other foods is consumed with the resultant production of carbon dioxide or other products of combustion in various degrees of oxidation, and, as stated before, mechanical energy is made available by a process not clearly understood.

Viewed from the standpoint of a machine, the animal is a wonderful mechanism. Not only is it self-feeding, self-controlling, self-maintaining and self-reproducing, but at the same time is a very efficient motor. While the horse is like heat engines in requiring carbonaceous fuel, oxygen, and water for use in developing energy, it is necessary that combustion take place in the animal body at a much lower temperature than is possible in the heat engine, and a much smaller proportion of the fuel value is lost in the form of heat while the work is being done. The animal is the only prime mover in which combustion takes place at the ordinary temperature of 98° F. For this reason the animal is one of the most efficient of prime

movers. That is, a large per cent of the energy represented by the food eaten is converted into work, a larger per cent than is possible to realize in most motors. Professor Atwater in his recent experiments found the average thermodynamic efficiency of man to be 19.6 per cent. Experiments conducted by the scientist Hirn have shown the thermodynamic efficiency of the horse to be about 0.2. The best steam engines give an efficiency equal to this, but the average is much below. Internal-combustion engines will give a thermal efficiency from 20 to 30 per cent.

**400. Muscular development.**—It is possible to consider the animal as a motor, but the animal is made up of a great number of systems of levers and joints, each supplied with a system of muscles which are in reality the motors. Muscles exert a force in only one way, and that by shortening, giving a pull. For this reason muscles are arranged in pairs, as illustrated by the biceps and triceps, which move the forearm. It is not clearly understood just how muscles are able to exert forces as they do when stimulated by nerve action. The theory has been advanced that the shortening of the muscles is due to a change of the form of the muscular cell from an elongated form to one nearly round, produced by pressure obtained in some way within the cell walls. There is no doubt but there is a transformation of heat energy into mechanical energy. While at work and producing motion there is but little change in the temperature of the muscles, but when the muscles are held in rigid contraction, there is a rise in temperature. Another author\* has likened this to a steam plant, which while at work converts a large portion of the heat generated in the fire box into mechanical energy, but as soon as the engine is

\*F. H. King, in "Physics of Agriculture."

stopped and the flow of steam from the boiler stopped the temperature rises rapidly.

**401. Strength of muscles.**—All muscles act through very short distances and upon the short end of the levers composing the animal frame. Acting in this way speed and distance are gained with a reduction in the magnitude of the force. A striking example of the strength of a muscle is that of the biceps. This muscle acts upon the forearm, while at a right angle with the upper arm, as a lever of the second class, with a leverage of 1 to 6. That is, the distance from the point of attachment of the muscle to the elbow is but one-sixth of the distance from the hand to the elbow. A man is able to hold within the hand, with the forearm horizontal, as explained, a weight of 50 pounds, necessitating an exertion of a force of 300 pounds by the muscle. Attention may also be called to the enormous strength of muscles of a horse as they act over the hock joint while the horse is exerting his maximum effort, in which case the pull of the muscles may amount to several thousand pounds.

It is because muscles are able to act only through very short distances that it is necessary for them to act upon the short end of the levers in order to secure the proper speed or sufficiently rapid movement.

**402. Animals other than horse and mule used for power.**—Dogs and sheep are used to a very limited extent in the production of power by means of a tread power similar to the one shown in Fig. 200 for horses. These may be used to furnish power for a churn or some other machine requiring little power. The use of cattle for power and draft has been practically discontinued in America. An ox at work will travel only about two-thirds as fast as a horse.

**403. Capacity.**—A man working a crank or winch can

develop power at his maximum rate. It is also possible to develop power at very nearly the maximum rate while pumping. A large man working at a winch can exert 0.50 horse power for two minutes and one-eighth horse power by the hour. It is stated that an ox will develop only about two-thirds as much power as a horse, owing to the fact that he moves at a much slower speed.

**404. The horse** is the only animal used extensively at present as a draft animal or for the production of power. As reported in the Twelfth Census, the number of horses and mules on the farms in the United States was 15,517,052 and 2,759,499, respectively, making a total of 18,276,551 animals. If it be assumed that each animal develop two-thirds horse power, the combined horse power while at work would be 12,184,366, an excess of 184,285 horse power over that used for all manufacturing purposes during the same year, 1900.

From a consideration of the skeleton and muscular development, it is perceived that the horse is an animal specially well adapted to dragging or overcoming horizontal resistances rather than for carrying loads. With man it is different. Although greatly inferior in weight, man is able to bear a burden almost as great as that of a horse, while at dragging he is able to exert only a small horizontal effort, even when the body is inclined well forward. The skeleton of man is composed of parts superimposed, forming a column well arranged to bear a burden. The horse is able to draw upon a cart a load many times his own weight, while he is unable to carry upon his back a load greater than one-third his weight.

It is to man's interest that his best friend in the brute world should be strong, live a long life, and waste none of his vital forces. Much attention has been given to the

development of breed in horses. The result is a great improvement in strength, speed, and beauty. But while attention has been turned to developing horses capable of doing better work, few have tried to improve the conditions under which they labor.

That the methods are often unscientific can be pointed out. In England, T. H. Brigg, who has made a study of the horse as a motor, and to whom we must give credit for the preceding thought, states that the horse often labors under conditions where 50 per cent of his energy is lost. It is a very strange thing that men have not studied this thing more, in order that people might have a better understanding of the conditions under which a horse is required to labor.

The amount of resistance which a horse can overcome depends on the following conditions: First, his own weight; second, his grip; third, his height and length; fourth, direction of trace; and fifth, muscular development. These will be taken up in the above order.

**405. Weight.**—The heavier the horse, the more adhesion he has to the ground. The tendency is to lift the forefeet of the horse from the ground when he is pulling, and thus a heavier horse is able to use his weight to good advantage. It is to be noted that often a horse is able to pull a greater load for a short time when he has upon his back one or even two men. Experienced teamsters have been known to make use of this method in getting out of tight places with their loads.

**406. Grip.**—That the weight adds to the horse's grip is self-evident, but cohesion is not the same thing as grip. Grip is the hold the horse is able to get upon the road surface. It is plain that a horse cannot pull as much while standing on ice as on solid ground unless his grip is increased by sharp calks upon his shoes. A difference is

to be noticed in roads in the amount of grip which a horse may get upon the surface while pulling a heavy load. Under ordinary circumstances the improved stone road will not provide the horse with as good a grip as a common earth road.

**407. Height and length.**—A low, rather long-bodied horse has much the advantage over a tall, short horse for heavy draft work. He has his weight in a position



FIG. 197—OBTAINING THE WORK OF A HORSE WITH A RECORDING DYNAMOMETER

where he can use it to better advantage. It is an advantage to have the horse's weight well to the front, since there is a tendency, as mentioned before, to balance his weight over his rear foot as a fulcrum. Horses heavy in the foreshoulder have an advantage in pulling over those that are light, as weight in the foreshoulder adds greatly to the ability of the horse to pull. To prove that this is true, it is only necessary to refer to the fact that horses when pulling extend their heads well to the front.

**408. Direction of trace.**—A heavy load may be lifted by a common windlass if the pull be vertical, but if the pull be transferred over a pulley and carried off in a horizontal direction the machine must be fastened or it will move. It must be staked and weighted to prevent slipping. This

same principle enters into the discussion of the draft of a horse. As long as the trace is horizontal, the horse has to depend upon his grip and his weight only to furnish enough resistance to enable him to pull the load. But if the trace be lower than horizontal the tendency is then to draw the horse on to the ground and thus give him greater adhesion. If the horse has sufficient adhesion to pull a load without lowering the trace it is to his advantage because the draft is often less in this case than any other.

**409. Line of least draft.**—When the road bed is level and hard, the line of least draft to a loaded carriage is nearly horizontal because the axle friction is but a small part of the weight.

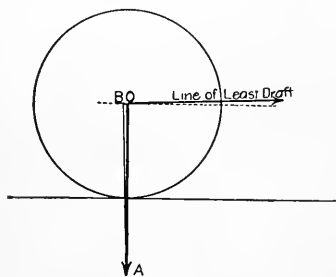

FIG. 198

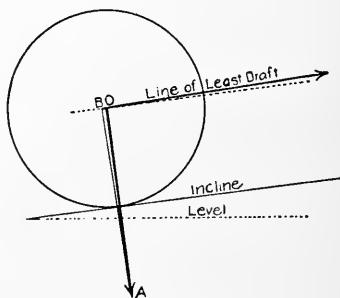

FIG. 199

Thus in Fig. 198, if AO represent by direction and magnitude the weight upon the axle, and OB in like manner the resistance of friction, the direction of the least force required to produce motion will be perpendicular to AB, a line joining the two forces. The angle that the line of least draft makes with the horizontal is named in mechanics, the angle of repose. If the resistance of friction be that of sliding friction and not that of axle friction, the angle of repose will be much greater.



If the road surface be inclined, it will be found that the line of least draft is nearly parallel to the road surface. If the trace is inclined upward from the line of least draft there is a tendency to lift the load; if the line of draft is inclined downward there is a tendency to press the load on the surface. Furthermore, it is found that roads are not perfectly level and there are obstructions over which the wheels of vehicles must pass, or, in other words, the load at times must pass up a much greater incline than a general slope indicates, and hence this calls for a greater angle of trace than will be needed for level or smooth road. Teamsters find in teaming over roads in one locality that they need a different angle of trace than they find best in another, because the grades of the roads are different.

**410. Width of hock.**—As mentioned before (405) practically all of the pull a draft horse exerts is thrown upon his hind legs and for this reason the form and strength of this part must be considered in the selection of a horse for draft purposes. If the hock is wide or, in other words, if the projection of the heel bone beyond the joint is large, the muscles will be able to straighten the limb under a greater pull than if the projection is small; thus the ability of the horse to overcome resistance will be increased. Thus there are many things to be considered in the selection of a draft horse. The general make-up of a horse built for speed is notably different from one built for draft purposes.

**411. The horse at work.**—When a horse is required to exert the maximum effort, it is necessary to add to his adhesion or grip so that he may be able to exert his strength to a limit without any slipping or without a tendency to slip. But if the horse is loaded all the time, either by a load upon his back or a low hitch, he is at

times doing more work than necessary. In fact, a certain amount of effort is required for the horse to stand or to walk even if he does no work at all. This has led men to think that if the hitch could be so arranged as to relieve the horse entirely of neck weight at times or even raise his trace the horse would be able to accomplish more in a day of a given length. In fact, it might be even an advantage to carry part of the weight of the horse. Although not a parallel case, it is sometimes pointed out that a man can go farther in a day when mounted on a bicycle than when walking. Walking in itself, both for man and beast, is labor, and in fact walking is like riding a wheel polygonal in form, and each time the wheel is rolled over a corner, the entire load must be lifted only to drop again as the corner is passed. Whether or not there are any possibilities in the development of a device along this line to conserve the energy of the horse we do not know; however, the argument seems very good. Mr. Brigg, of England, has devised an appliance for applying to vehicles with thills which will in a measure accomplish the result referred to; that is, the horse on beginning to pull will be gradually loaded down, thus permitting him to overcome a greater resistance.

**412. Capacity of the horse.**—The amount of work a certain horse is able to do in a day is practically a constant. Large horses are able to do more work than smaller ones, but a given horse can do only about so much work in a day even if he is given a long or a short time in which to do it. Not only is the ability to do work dependent upon the size, but also upon the natural strength, breed, health, food, environment, climate, adaptation of the load, and training of the horse. A horse with maximum load does minimum work, when traveling at maximum speed he can carry no load, so at some inter-

mediate point the horse is able to do the maximum amount of work.

**413. Best conditions for work.**—The average horse will walk from 2 to  $2\frac{3}{4}$  miles an hour, and at the same time overcome resistance equal to about one-tenth or more of his weight. Work may be performed at this rate for ten hours a day. Assuming the above to be true, a 1,500-pound horse will perform work at the rate of one horse power.

As 1,500 pounds is much above the average weight of a farm horse the average horse whose weight is not far from 1,100 will do continuous work at the rate of about  $\frac{2}{3}$  to  $\frac{4}{5}$  horse power.

**414. Maximum power of the horse.**—Entirely different from other motors, the horse, for a short time at least, is able to perform work at a very much increased rate. A horse when called upon may overcome resistance equal to one-half his weight, or even more. The horse power developed will be as follows, assuming that he walk at the rate of  $2\frac{1}{2}$  miles an hour (see Art. 20):

$$\text{H. P.} \frac{1,500 \times \frac{1}{2} \times 2\frac{1}{2} \times 5,280}{33,000} = 5$$

A horse will be able to do work at this rate for short intervals only. The fact that a horse can carry such a heavy overload makes him a very convenient motor for farm purposes.

The maximum effort or power of traction of a horse is much greater than one-half his weight. A horse weighing 1,550 pounds has been known to overcome, when pulling with a horizontal trace, a resistance of 1,350 pounds. With the point of hitch lowered until the trace made an angle of  $27^\circ$  with the horizontal, the same horse was able to give a draft of 1,750 pounds. It is believed, however, that this horse is an exception.

**415. Effect of increase of speed.**—As stated before, a horse at maximum speed cannot carry any load, and as the speed is increased from the normal draft speed, the load must be decreased. It is stated that the amount of work a horse is capable of doing in a day is constant within certain limits, varying from one to four miles an hour. Assuming this, the following equation holds true:

$$2\frac{1}{2} \times \text{traction at } 2\frac{1}{2} \text{ miles} = \text{miles per hour} \times \text{traction.}$$

**416. Effect of the length of working day.**—Within certain limits the traction a horse is able to exert varies inversely with the number of hours. When the speed remains constant the traction may be determined approximately by the following equation, provided the length of day is kept between five and ten hours.

$$10 \text{ hours} \times 1/10 \text{ weight of horse} = \text{number of hours} \times \text{traction.}$$

**417. Division of work.**—It may not be absolutely true that the ability of a horse to do work depends largely upon his weight, nevertheless it is not far from correct. It is not advisable to work horses together when differing much in size, but it is often necessary to do so. When this is done the small horse should be given the advantage. In determining the amount of the entire load each horse should pull when hitched to an evener it may be considered a lever of the second class; the clevis pin of one horse acting as the fulcrum. From the law of mechanics (see Art. 24):

$$\text{Power} \times \text{power arm} = \text{weight} \times \text{weight arm.}$$

Example: Suppose two horses weighing 1,500 and 1,200 pounds respectively are to work together on an evener or doubletree 40 inches long. If each is to do a share of the work proportionately to his weight, it will be possible to substitute their combined weight for the total

draft and the weight of the larger horse for his share of the draft in the general equation and consider the smaller horse hitched at the fulcrum :

$$2,700 \times \text{long arm of evener} = 1,500 \times 40,$$

$$\text{long arm of evener} = \frac{60,000}{2,700} = 22 \frac{2}{9} \text{ inches,}$$

$$\text{short arm of evener} = 40 - 22 \frac{2}{9} = 17 \frac{7}{9}.$$

That is, to divide the draft proportionately to the weights of the horses, the center hole must be placed  $22 \frac{2}{9}$  inches from the center toward the end upon which the heavy horse is to pull.

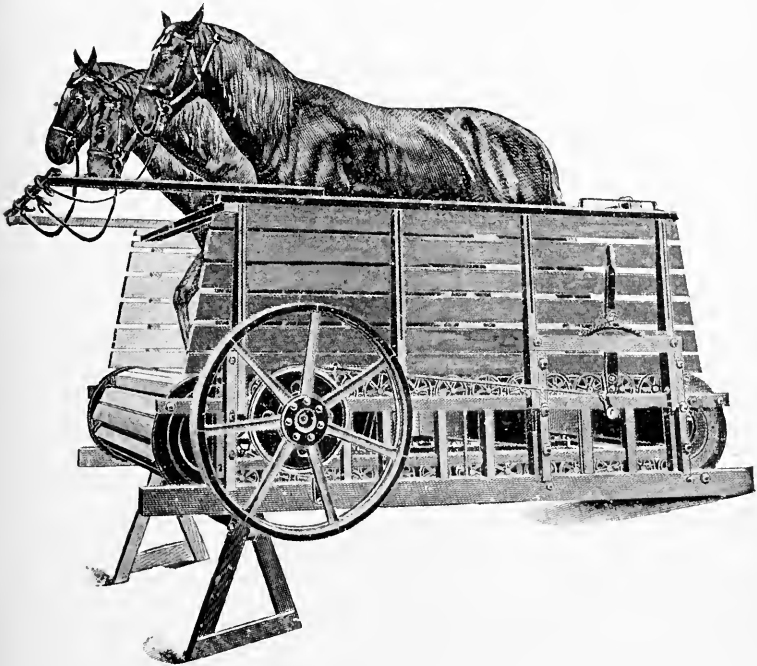

FIG. 200—TREAD POWER FOR THREE HORSES

418. The tread power.—The tread power consists in an endless inclined plane or apron carried over rollers

and around a cylinder at each end of a platform. Power is derived from a pulley placed upon a shaft passing through one of the cylinders. Fig. 200 illustrates a tread power for three horses with the horses at work. Some aprons are made in such a way that each slat has a level face. This tread is thought to enable the horse to do his work with less fatigue because his feet are more nearly in their normal attitude.

Owing to the large number of bearings, the matter of lubrication is an important feature in the operation of a tread power. Lubrication should be as nearly perfect as possible in order that little work will be lost in friction and the efficiency of the machine may be increased. The bearings should not only have due provision for oiling, but they must be so constructed that they will exclude all dirt and grit.

**419. The work of a horse in a tread power.**—A horse at work in a tread power lifts his weight up an incline against the force of gravity. The amount of work accomplished depends upon the steepness of the incline and the rate the horse travels. If the incline has a rise of 2 feet in 8, the horse must lift one-fourth of his weight, which is transmitted to the apron and travels at the same rate the horse walks. Working a 1,000-pound horse in a tread power with a slope of 1 to 4 is equal to a pull of 250 pounds by the horse. This is much greater than is ordinarily required of a horse, but it is not uncommon to set the tread power with this slope. If a horse weighs 1,600 pounds and walks at the rate of two miles an hour, work will be done at the rate of 2.13 H.P. At the same speed a 1,000-pound horse will do 1.33 H.P. of work.

It is often true that a horse will be able to develop much more power when worked in a tread power than when worked in a sweep power, but he will be overworked.

Often horses are overworked in tread powers without the owner intending to do so, or even knowing it.

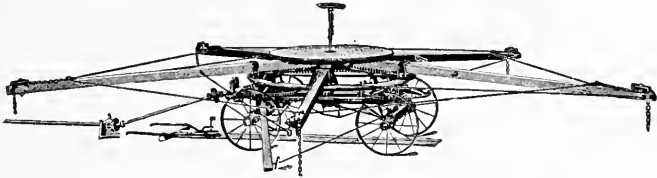

FIG. 201

**420. Sweep powers.**—In the sweep power the horses travel in a circle, and the power is transmitted from the master wheel through suitable gearing to the tumbling rod, which transmits the power to the machinery. Sweep powers vary in size from those for one horse to those for 14 horses. Attention is often called to the fact that a considerable part of the draft is lost because the line of draft cannot be at right angles to a radius of the circle in which the horse walks. For this reason a considerable portion of the draft is lost in producing pressure toward the center of the power, often adding to the friction. The larger the circle in which the horse travels, the more nearly the line of draft will be at right angles to a radius to the center of the circle.

## CHAPTER XVII

### WINDMILLS

If the horse is excepted, the windmill was the first kind of a motor used to relieve the farmer of physical exertion and increase his capacity to do work. With the exception of the horse, the windmill is still the most extensively used. To prove that the windmill is an important farm motor, it is only necessary to cite the fact that many thousand are manufactured and sold each year.

**421. Early history**—Prof. John Beckmann, in his "History of Inventions and Discoveries," has given everything of special interest pertaining to the early history of the windmill. As it is conceded by all that his work is exhaustive, the following notes of interest have been taken from it. Prof. Beckmann believes that the Romans had no windmills, although Pomponius Sabinus affirms so. He also considers as false the account given by an old Bohemian annalist, who says that before 718 there were windmills nowhere but in Bohemia, and that water mills were then introduced for the first time. Windmills were known in Europe before or about the first crusade. Mabillon mentions a diploma of 1105 in which a convent in France is allowed to erect water wheels and windmills. In the twelfth century windmills became more common.

**422. Development of the present-day windmill.**—It was about the twelfth century that the Hollanders put into use the noted Dutch mill. These people used their mills for pumping water from the land behind the dikes into the sea. Their mills were constructed by having four sweeps extending from a common axle, and to these sweeps were attached cross pieces on which was fastened canvas. The first mills were fastened to the tower, so that when the direction of the wind changed the owner would have to go out and swing the entire tower around; later they fastened them so that only the top of the tower turned, and in some of the better mills they were so arranged that a smaller mill was used to swing the wheel to the wind. The turning of the tower was no small matter when one learns that some of these mills were 140 feet in diameter.



John Burnham is said to be the inventor of the American windmill. L. H. Wheeler, an Indian missionary, patented the Eclipse in 1867. The first steel mill was the Aermotor, invented by T. O. Perry in 1883.

The windmills still most common in Europe are of the Dutch type, with their four long arms and canvas sails. These sails usually present a warped surface to the wind. The degree of the angle of the sails with the plane of rotation, called the angle of weather, is about  $7^{\circ}$  at the outer end and about  $18^{\circ}$  at the inner. The length of the sails is usually about  $\frac{5}{6}$  the length of the arms, the width of the outer end  $\frac{1}{3}$  the length, and the width of the inner end  $\frac{1}{5}$  the length. It is seen that the total projected area of sails is very small compared to the wind area or zone carrying the sails. Quite often these wheels are 120 feet in diameter and occasionally 140 feet. In comparing these mills with the close, compact types of American makes a very great contrast is to be drawn.

Among the men who have done the most experimenting in windmill lines are Smeaton, Coulomb, Perry, Griffith, King, and Murphy. The names are given in order of date of experimenting. The more prominent among these are Smeaton, Perry, and Murphy. Probably Perry did more for the windmill than any of the others. Prof. E. H. Barbour is noted for his designs and work with home-made windmills.

**423. Home-made windmills.**—Professor Barbour made an extensive study of home-made windmills and has had a very interesting bulletin published on the subject. He has classified them as follows:

1. Jumbos (Fig. 202). This type consists of a large fan-wheel placed in a box so the wind acts on the upper fans only.
2. Merry-go-rounds. Merry-go-round mills are those in which the fans in turning toward the wind are turned edgewise.
3. Battle-ax mills (Fig. 203). These are mills made with fans of such a shape as to suggest a battle-ax.
4. Holland mills. Somewhat resembling the old Dutch mill.
5. Mock turbines (Fig. 204). Resembling the shop-made mill.
6. Reconstructed turbines (Fig. 205). Shop-made mills rebuilt.

These mills, although of low power, are used extensively in the West Central States. Most of them are fixed

in their position and consequently have full power only when the wind is in the direction for which they are set. In those States in which these mills are used the wind

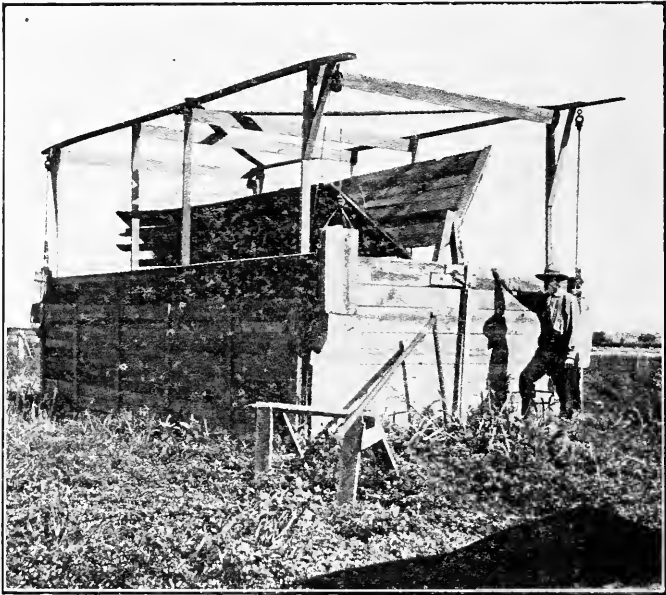

FIG. 202—HOME-MADE JUMBO

has the prevailing directions of south and northwest, and for that reason the mills are generally set a trifle to the west of north.

To the casual observer the Jumbo mill (Fig. 202) seems a very feasible means of obtaining power, but when one considers the massiveness of the whole affair and that only one-half of the sails is exposed to the wind at one time, also that full power is developed from the wind only when the latter is in the proper direction, it will immediately be seen that only in cases of dire necessity should one waste much time with them.

The cost of this type of mill is very slight. It is stated by Professor Barbour that a gardener near Bethany, Nebraska, constructed one which cost only \$8 for new material, and with this he irrigates six acres of vegetables. If the water-storage capacity for such mills is enough, they will often furnish sufficient water for 50 head of stock. One farmer has built a gang of Jumbo mills into the cone of a double corn crib and connected them to a small sheller.

The Merry-go-round is not nearly as popular as the Jumbo, in that it is very much harder to build and the only advantage it has over the latter is that a vane may be attached

in such a manner that the wind wheel is kept in the wind.

In some parts of Kansas and in several localities of Nebraska the Battle-ax mill is used probably more than any other type of home-made mill. The stock on large ranches is watered by using such mills for pumping purposes. Where one has not sufficient power, two are used. The cheapness of these mills is a consideration; very seldom do they cost more than \$1.50 outside of what can be



FIG. 203.—BATTLE-AX WINDMILL

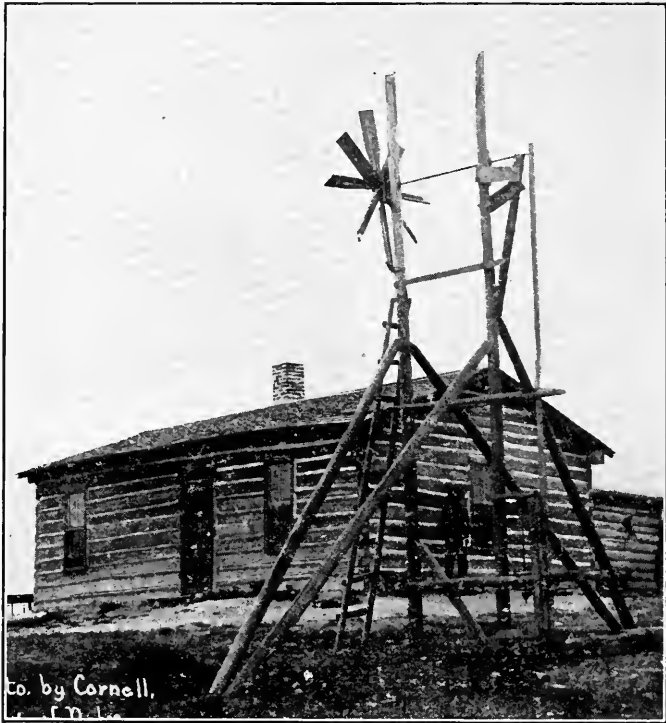

FIG. 204—MOCK TURBINE WINDMILL

picked up around the farm. The axle can be made of a pole smoothed up at the ends for bearings, or a short rod can be driven in at each end. The tower can be made of three or four poles and the sails of pole cross pieces and old boxes. One of these mills 10 feet in diameter will pump water for 75 head of cattle. Near Verdon, Nebraska, a farmer uses one of these mills in the summer to pump water for irrigation, and in the winter for sawing wood.

**424. Turbine windmills.**—The term windmills as it is commonly used refers only to the American type of

shop-made mills. They may be classified by the form of the wheel and the method of governing.

1. Sectional wheel with centrifugal governor and independent rudder (Fig. 206).
2. The solid-wheel mill with side-vane governor and independent rudder (Fig. 207).
3. Solid wheel with single rudder. Regulation depends upon the fact that the wheel tends to go in the direction it turns. To aid in governing, the rudder is often placed outside of the center line of wheel shaft (Fig. 208).
4. Solid or sectional wheel with no rudder back of tower, the pressure of the wind being depended upon to keep the mill square with the direction of the wind. Regulation is accomplished with a centrifugal governor (Fig. 209).



FIG. 205—RECONSTRUCTED TURBINE

**425. The use of the windmill.**—The windmill receives its power from the kinetic energy of the moving atmosphere. Since this is supplied without cost, the power furnished by a windmill must be very cheap, the entire cost being that of interest on the cost of plant, depreciation and maintenance. Where power is wanted in small units the windmill is a very desirable motor, provided—

1. The nature of the work is such as to permit of a suspension during a calm, as pumping water and grinding feed.
2. Some form of power storage may be used.

**426. Wind wheels.**—T. O. Perry built a frame on the end of a sweep which revolved in an enclosed room in such a manner that he could fasten different wheels on it without making any change in the mechanism. By this means

he was able to make very exhaustive experiments without being retarded by atmospheric conditions. He made

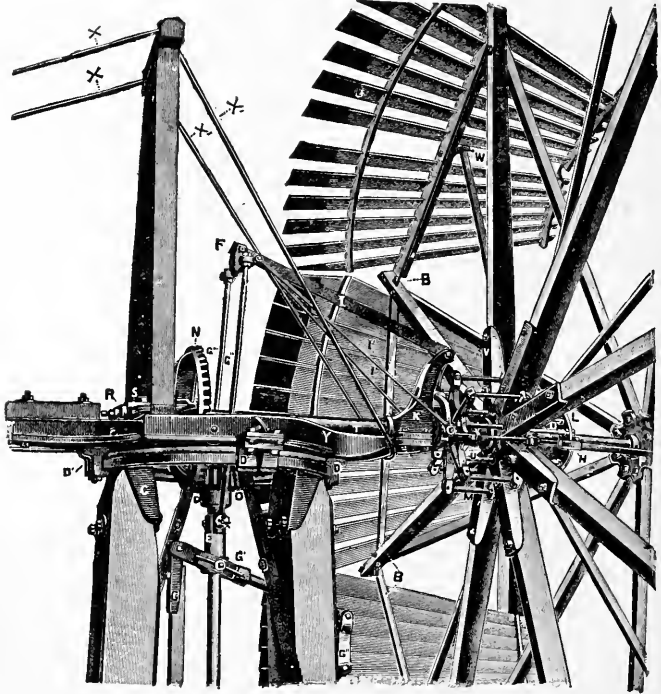

FIG. 206—SECTIONAL WHEEL WITH CENTRIFUGAL GOVERNOR AND INDEPENDENT RUDDER

tests with over 60 different forms of wheels, and it was the result of these experiments which brought out the steel wheel. From Mr. Perry we learn that in wood wheels the best **angle of weather** is about  $30^\circ$ , and that there should be a space of about one-eighth the width of the sail between the sails. By **angle of weather** is meant the angle made by the blade and the plane normal or perpendicular to the direction of the wind. With the tower in

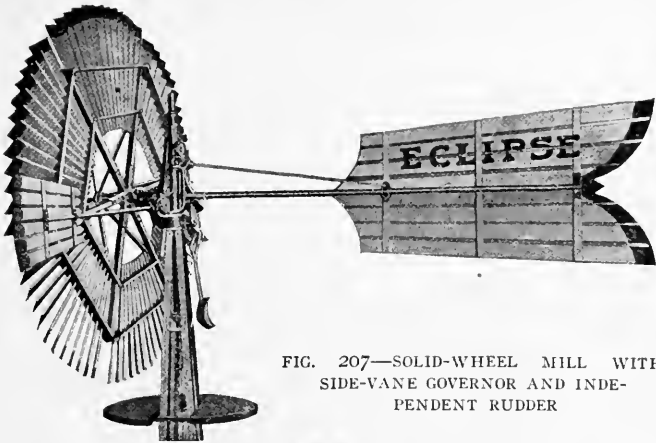

FIG. 207—SOLID-WHEEL MILL WITH  
SIDE-VANE GOVERNOR AND INDE-  
PENDENT RUDDER

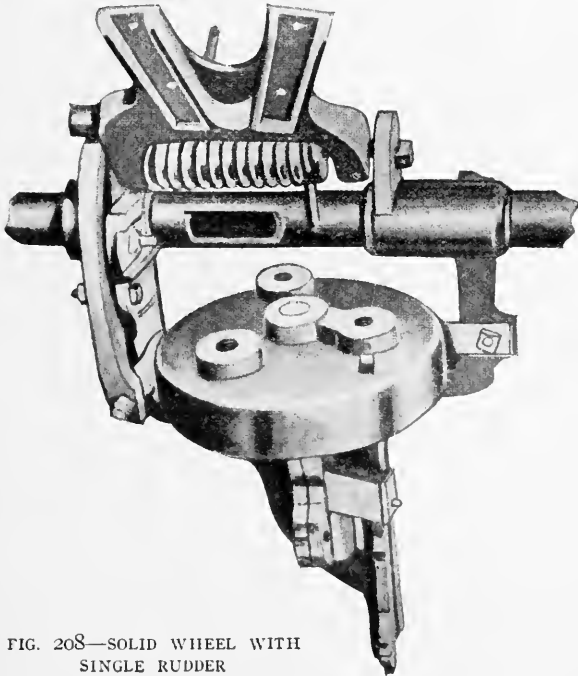

FIG. 208—SOLID WHEEL WITH  
SINGLE RUDDER

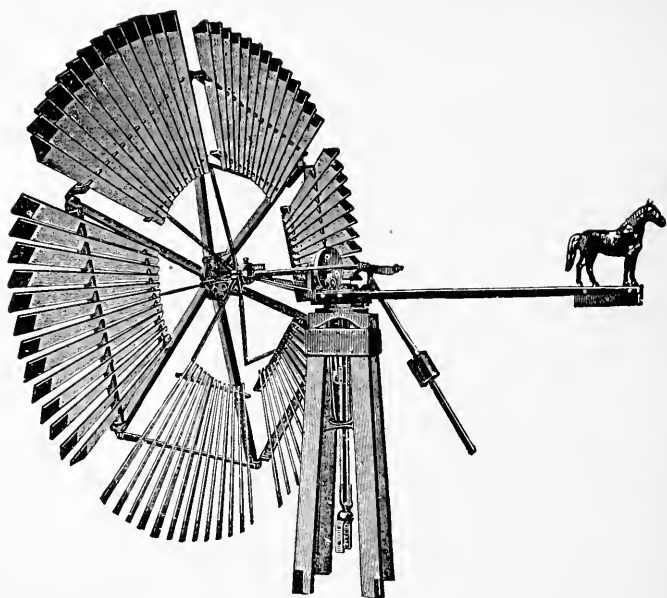

FIG. 209.—SECTIONAL WHEEL WITH NO RUDDER

front of the wheel there is a loss of efficiency of about 14 per cent; with it behind the wheel there is a loss of only about 7 per cent.

**427. Regulation.**—Wind wheels of this country are made to regulate themselves automatically, and by this means of regulation they do not attain a very high rate of speed, nearly all of them cutting themselves out when the wind has reached a velocity of about 25 miles an hour. This is principally due to the fact that our mills are generally made for pumping purposes and the pumps do not work well when the number of strokes becomes too great. It is for this reason that the direct-connected wooden wheels do not give as much power as the back-gearred steel wheels. As a result of the wind wheels being



thrown partially out of gear when the wind velocity is only about 25 miles an hour, many wheels are kept from doing the amount of work which they might be able to do. Any mill should stand a velocity of at least 40 miles an hour. It is understood that as the wind increases, the strain on the working parts decreases. For any given velocity of wind the speed of the wheel should not change, but the load should be so arranged that the work can be done to suit the wind.

**428.** The **efficiency** of a wind wheel is very greatly affected by the diameter. This is due to the fact that wind is not the same in any two places on the wheel. The smaller the wheel, the greater efficiency. Experiments were attempted to get the efficiency of a 22-foot wheel, but because the wind did not blow at the same velocity on any two parts of the wheel they were given up.

**429. Gearing.**—At one time the wind wheel seemed to be the most vital part of a windmill, but from the results of tests and experiments this belief has been obliterated, and now the vital part seems to be the gearing. On all the old standard makes the gearing seems to be as good as ever, even if the mills have run for several years. However, on the new designs, and this is mostly the steel mill, the gears are wearing out. The fault lies with no one but the manufacturers. Competition has been so strong that they have reduced the cost of manufacture at the expense of wearing parts. For this reason the steel wheel, which is far the more powerful, is going out of use in some localities, and the old makes of wooden wheels are coming back.

In direct-connected mills the main bearings should be long and so placed that they will carry the wheels in good shape, and the guide should be heavy and designed so that it can be lubricated easily. The bumper spring

should be well placed, not too close in, so that as the wheel is thrown out of the wind there is not too much jar. Rubber should never be used for this spring, as the continual use and exposure to the weather will cause it to harden or flatten so that it is of no use. Generally weights are better to hold the wheel in the wind than springs.

In support of back or forward geared mills there is not much more to say than has been said about direct connected. The most vital parts of these mills other than named above are the gearings. They must be well set and well designed so that when they wear there is not a very great chance for them to slip.

**430. Power of windmills.**—Probably there is no other prime mover which has so many variables depending upon it as the windmill, when we undertake to compute the power by mathematical means. It is also hard to distinguish between the greatest and the least of these variables, so the author gives them promiscuously. Variable velocity of wind; velocity greater on one side of wheel than on the other; angle of weather of the sails; thickness of sails; width of sails; number of sails; length of sails; obstruction of tower either behind or in front of wheel; diameter of wheel; velocity of sails; variation of load, and location and height of tower. In all the tests of windmills which have been carefully and completely carried out it is shown that as the wind velocity increases or decreases the load should increase or decrease accordingly; as the velocity of the wheels increases, the angle of weather should decrease, and vice versa. Wide sails give more power and a greater efficiency than narrow sails.

A. R. Wolff gives the following table as results for wood-wheel mills:

Size of Wheel	R. P. M. of Wheel	Gallons of Water raised per Minute to an Elevation of						H. P. Developed
		25'	50'	75'	100'	150'	200'	
10'	60-65	19.2	9.6	6.6	4.7			0.12
12'	55-60	33.9	17.9	11.8	8.5	5.7		0.21
14'	50-55	45.1	22.6	15.3	11.2	7.8	5.0	0.28
16'	45-50	64.6	31.6	19.5	16.1	9.8	8.0	0.41
18'	40-45	97.7	52.2	32.5	24.4	17.5	12.2	0.61
20'	35-40	124.9	63.7	40.8	31.2	19.3	15.9	0.78
25'	30-35	212.4	107.0	71.6	49.7	37.3	26.7	1.34

The above table is given where the wind velocity is such that the mill makes the number of revolutions a minute given; of course, if the velocity increases, the R.P.M. will increase likewise and consequently the power.

Smeaton drew from his experiments that the power increases as the cube of the wind velocity and as the square of the diameter of the wheel. Murphy did not check this result, but found that the power increases as the squares of the velocity and as about 1.25 of the diameter of the wheel. This latter conclusion is probably the more reliable, as the instruments which Smeaton used were more crude than those of Murphy. The former determined the velocity of the wind by taking the time which it would take a feather to travel from one point to another as the velocity. The latter used a Thompson anemometer.

**431. Tests of mills.**—The following tests were made by E. C. Murphy to determine what windmills actually did in the field, also to see whether mills in practice carried out the rules made by previous experimenters. Perry found by his experiments in a closed room that the power of a wheel increases as the cube of the velocity, while Murphy found that it varied from this.

It will be noticed from the following table that some steel wheels as well as wooden gave much more power

Name	Kind	Diameter in Feet	Number Sails	Angle of Weather	Velocity of Wind in Miles per Hour	Horse Power
Monitor	Wood	12	96	34°	20	.357
Challenge	"	14	102	39°	20	.420
Irrigator	"	16	10	39°	20	.400
Althouse	"	16	130	32°	20	.600
Halliday*	"	22.5	144-100	25°	20	.890
Aermotor	Steel	12	18	31°	20	1.050
Ideal	"	12	21	32°	20	.606
Junior Ideal	"	14	24	29°	20	.610
Perkins	"	14	32	31°	20	.609
Aermotor	"	16	18	30°	20	1.530

\*This wheel was made up of two concentric circles of sails, the outer having 144 sails and the inner 100.

than others. This is due to workmanship and angle of weather.

It is very clearly shown that the steel wheel is much more powerful than the wooden.

Another important factor noticed from the above table is that the 16-foot mill develops only about 50 per cent more power than the 12-foot. Taking the shipping weights of the 12-foot and 16-foot mills with 50-foot steel towers, it is found that they are about 2,000 pounds and 4,200 pounds, respectively, and since a 16-foot mill is much more liable to be damaged by a storm than a 12-foot, it is better in a great many cases to put up two 12-foot mills instead of one 16-foot.

Mr. Murphy made tests of a Little Jumbo mill  $7\frac{3}{4}$  feet in diameter with eight sails, each  $11 \times 16$  feet, and found that in a 20-mile wind he got 0.082 H.P. and in a 25-mile wind he got 0.100 H.P. He also made tests of a Little Giant mill and by computation found that the latter mill, having the same dimensions as the former, would start in a slower wind and when at full speed would develop about 2.5 times as much power. Other advan-

tages of this mill over the former are that it is always in the wind and is much less liable to be injured by storms.

By a comparison of tables from different manufacturers of windmills the following table has been compiled of the size of steel windmills required for various lifts and size of cylinder. Although it cannot be said that the table is accurate, it conforms very closely to the general practice.

Size of Mill	Velocity of Wind	Size of Cylinder in Inches	Height of Lift	Size of Cylinder	Height of Lift	Size of Cylinder	Height of Lift	Size of Cylinder	Height of Lift	Size of Cylinder	Height of Lift
6	15	2"	100'	3"	50'	4"	25'				
8	15	2	100'	2½"	100'	3"	75'	4"	35'		
10	15	2"	300'	2½"	200'	3"	150'	4"	70'		
12	15	2	500'	2½"	375'	3"	250'	4"	125'		
16	15	2½"	800'	3"	500'	3½"	400'	4"	300'	5"	200'
20	15	3½"	800'	4½"	500'	5"	400'	7"	200'	8"	135'

The above table is for mills back-geared about 10 to 3. Since wood-wheel mills are generally direct-stroke, they require a much larger wheel to accomplish the same work as the steel wheels.

**432. Towers.**—The Hollanders built their towers in the form of a building which either had a revolving roof or the tower itself revolved. Within the tower they kept mills and grain. Often to-day we see the towers of American mills housed in a similar way, with the exception that they do not revolve. This is not an economical way of providing room, for it requires much more material in the construction than a low building does to withstand the excessive wind pressure which it receives.

Since the top of the tower vibrates greatly, the tower needs to be very stiff. Probably a wood tower is stiffer

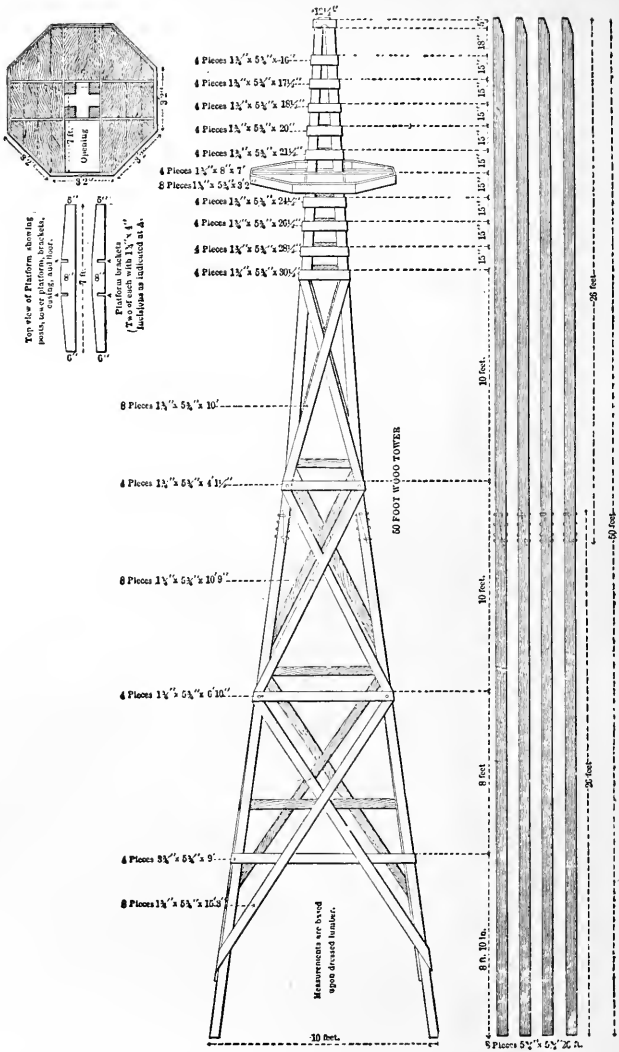

FIG. 210—DIMENSIONS FOR 50-FOOT TOWER

than steel when new, but owing to the variation in wind velocity and direction it is only a short time before the continual vibration has worked the tower loose at all joints and splices. At every joint in the wood tower there is a chance for the rain to run in and cause decay. Therefore as an offset to the greater rigidity of the wood tower one must consider the time for tightening bolts, labor for painting, and money for replacing the tower every few years.

**Steel towers**, as a rule, are not as rigid when new as the wood, but they do not present as great a surface to the wind as the latter, and since all parts are metal there is no chance for a loosening of the joints. The steel tower not only saves all of the labor and expense required to keep the wooden tower in repair, but it is practically indestructible.

In a cyclone the steel tower will often become twisted before the wooden one will be broken. However, the latter will generally become so racked and splintered that it cannot be repaired.

**433. Anchor posts** can be made by setting strong fence posts in the ground their full length and nailing some strips across them to hold beneath the earth; but a better method is to insert an angle iron in a concrete base, which will support the tower posts. The dimensions of the base should be about  $18 \times 18$  inches  $\times$  4 feet for small mills, and proportionally larger for large mills.

**434. Erecting mills.**—Windmills over 60 feet high should be assembled piece by piece, but low towers can be assembled on the ground, including windmill head, sails, and vanes, then raised in a manner similar to Fig. 211. After the tower has been raised it should be examined and all braces and stays given the same tension and all nuts tightened. It is also well before the pump

rod is put in place to drop a plumb bob from the center of the top of the tower to the intersection of cords stretched diagonally from the corners of the tower at

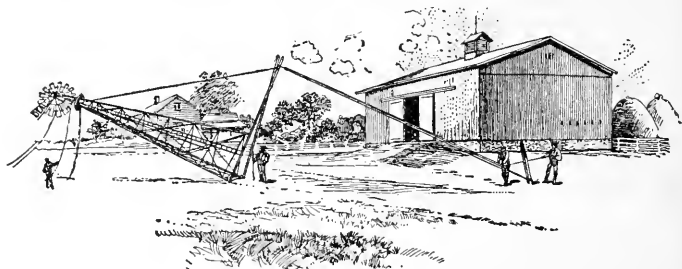

FIG. 211—RAISING A TOWER

the base. If the plumb bob does not fall on this intersection, either the braces do not have equal tension or the anchor posts are not level.

**435. Economic considerations of windmills.**—Many manufacturers claim much more power than the windmills really develop. This erroneous claim is probably due to the fact that early experimenters worked with small wheels and figured the power of larger ones from the law of cubes, which does not seem to hold true in actual practice. It is wrong to say that a good 12-foot steel mill will furnish 1 H.P. in a 20-mile wind and that a good 16-foot mill will furnish 1.5 H.P.

The economic value of a windmill depends upon its first cost, its cost of repairs, and its power. The competition in manufacture at present is so great that often the initial cost is kept down at the expense of the other two.

A mill should have as few moving parts as possible. The power of a mill is so small that if there is much to retard its action there will be very little power left for use.



In power mills very often the shafting is much heavier than need be. This is probably due to the fact that the mill was designed for much more power than it will actually develop. Often poor workmanship in manufacture as well as in erection is the cause of so many mills having such small power.

Trees, buildings, and embankments cause the wind velocity to be so variable that for good work it is desirable that the wind wheel be placed at least 30 feet above all obstructions. This would cause the towers to be at least 60 or 70 feet high. It is better to put a small wheel on a high tower than a large wheel on a low tower. An 8-foot wheel on a 70-foot tower will probably do more work in a given length of time than a 12-foot wheel on a 30-foot tower.

The pumping mill is ordinarily constructed so the work is nearly all done on the up stroke. This is hard on the mill, as it produces a very jerky motion and excessive strain on the working parts. By placing a heavy weight on one end of a lever and connecting the plunger rod to the other this strain is reduced, since when the plunger rod goes down it raises the weight, and when it comes up, lifting the pump valve and water, the weight goes down and thus assists the mill.

**436. How the wind may be utilized.**—In a country where there is such an abundant supply of wind as in the Central and Western States there is no doubt that a windmill is the cheapest and most feasible power for the farmer. In certain localities water power is a great opponent of the wind, but it has the disadvantage to the farmer of being in the wrong location, causing water rights to be looked after and dams to be kept in repair, while in utilizing the wind all that is required is some simple device which will turn wind pressure into work.

The windmill without doubt is the best machine for this, but since we cannot depend on the wind at all hours of the day, we must devise some scheme whereby we can store the work when the wind blows so that we may use it when there is no wind. For this means four ways come to mind: One is to connect a dynamo to the mill and store the electricity in storage batteries. This is not a feasible plan at present, since the expense of storage batteries and the cost of repairs is too great. Another plan is to run an air compressor by means of the wind and then use the compressed air for power purposes. This again is not satisfactory owing to the cost of keeping air machines in repair and also of conveying the air. Another scheme, and probably the best, is to pump water into a tank on a tower, and then let this water which has been stored up during the time of wind run down through a water motor and from thence to the yards, or, if there is more water than is desired for the stock and house use, run it into another tank below the tower and then pump it back. Another scheme which is similar to that named last is to pump the water into a pressure tank in the cellar and then let it pass out the same as in the tank on the tower. By this latter scheme the expense of the tower and the danger of freezing are obviated, but a more expensive tank and also an air pump are added.

**437. Power mills.**—The same discussion, which has been given more especially to pump mills, will apply to power mills. As a rule, power mills are larger than pump mills, and require more skill in keeping the bearings in repair. Care should be taken in erecting power mills that the shaft is in perfect alignment. A great deal of power can be lost by not having the shaft running in a perfect line.

## CHAPTER XVIII

### STEAM BOILERS

438. **Principle.**—A kettle over the fire filled with water is a boiler of small proportions. When fuel is burned beneath the kettle heat is transferred to the metal of the kettle and from the metal to the water at the bottom. Thus the water in direct contact with the bottom is heated, and, since warm water is lighter than cold, the warmer water rises to the top and the cold settles in its place. In physics this action of the water rising and falling in the kettle, conveying the heat from one part to another, is known as convection. In the steam boiler it is known as circulation. When sufficient heat has been transferred to the water to raise the temperature to  $212^{\circ}$  F. it will commence to boil and throw off steam.

The reason why the water had to be heated to  $212^{\circ}$  before the particles of water would be thrown off as steam was because the atmosphere, having a pressure of 14.7 pounds to each square inch, pressed upon it so hard that the steam could not be thrown off until this temperature had been reached. If the kettle were up on a mountain where the atmospheric pressure is not nearly as great, steam would have been thrown off at a lower temperature.

The same process which takes place in a steam boiler also takes place in a kettle, only under less economical conditions. A fire is maintained within the furnace of the boiler and the heat is transferred to the metal of the boiler shell and tubes, thence to the water, which is con-

verted into steam. The water of a low-pressure boiler, i.e., one which carries a pressure of only about 5 pounds gauge, is heated to only about  $228^{\circ}$  when steam is given off, while in a high-pressure boiler which carries about 200 pounds gauge pressure it has to be heated to about  $385^{\circ}$ .

The first boilers were simply large cylindrical shells. They did the work required of them, but were very in-

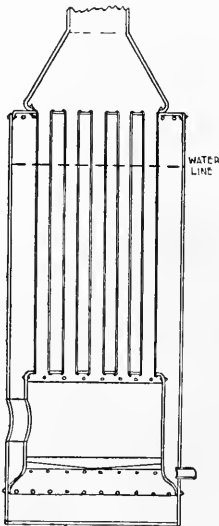

FIG. 212—VERTICAL BOILER

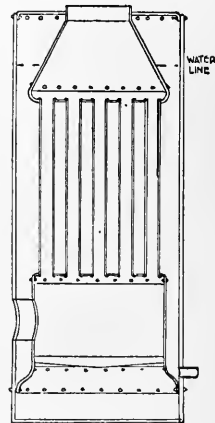

FIG. 213—VERTICAL BOILER  
WITH SUBMERGED FLUES

efficient. The next was merely a shell with one tube or flue, as it is often called. Multitubular, return tubular, internally fired, water-tube, sectional boilers, etc., have come in in succession until we have the present-day types.

**439. Classification.**—Steam boilers may be classified according to their form and use. Thus we have locomotive,

marine, portable, semi-portable, and stationary boilers, according to use; and according to form we have horizontal and vertical boilers. Further, the horizontal class may be subdivided into internally and externally fired, shell, return-flue, fire-tube and water-tube boilers. For

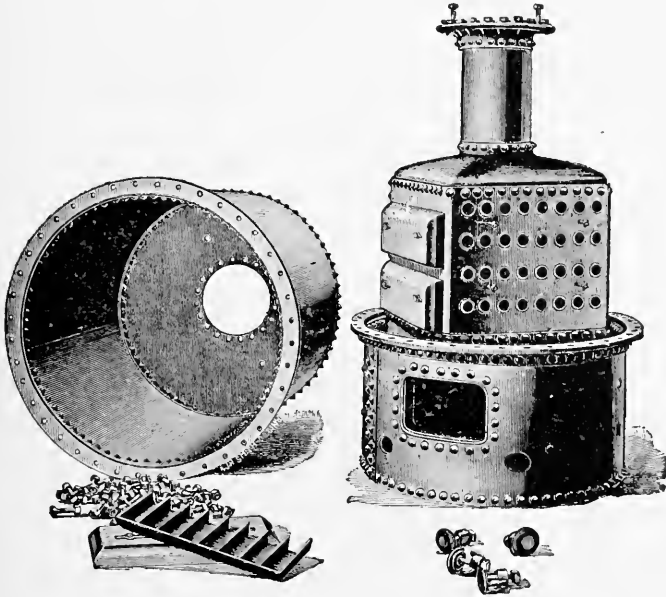

FIG. 214—WATER-TUBE VERTICAL BOILER

rural use the marine type is very seldom used, and the sectional only in rare cases.

**440. Vertical boilers.**—Boilers of this type (Fig. 212) are not very economical. They require little floor space and are easily installed. In construction they consist of a vertical shell, in the lower end of which are the fire box and ash pit; extending up from the furnace and reaching the top are the fire flues.

Since the shell of the fire box is under external pressure, it must be stayed to avoid collapsing. The blow-off cock and frequent hand holes are near the base for

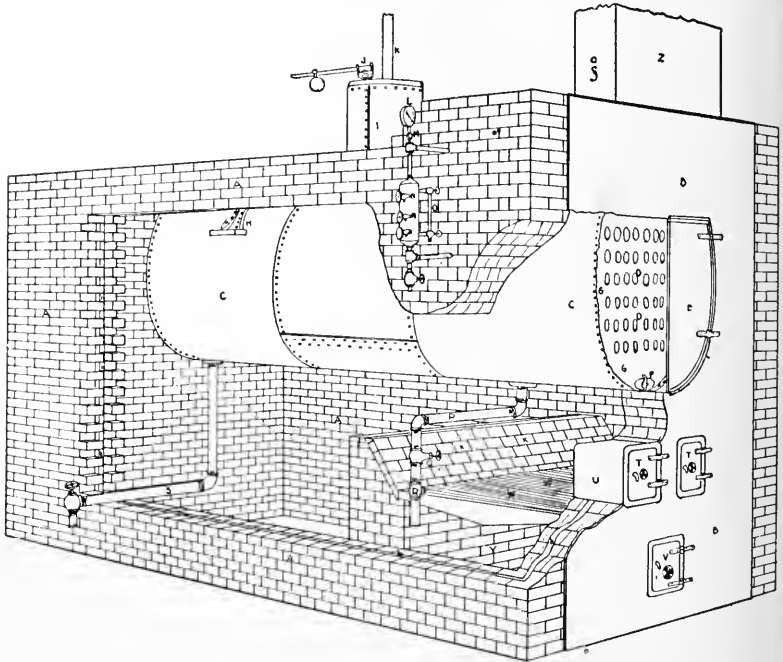

FIG. 215—EXTERNALLY FIRED BOILER

*AA*, boiler setting; *BB*, boiler front; *CC*, boiler shell; *DD*, flues; *E*, flue door; *F*, handhole; *G*, flue sheet; *H*, bracket; *I*, steam dome; *J*, safety valve; *K*, steam pipe; *L*, steam gauge; *M*, steam gauge syphon; *NN*, try cocks; *O*, water glass; *PS*, blow-off pipes; *Q*, blow-off valve; *TT*, fire door; *U*, fire door lining; *V*, ash door; *W*, grates; *X*, bridge wall; *Y*, ash pit; *Z*, britchen; *A*, damper.

convenient cleaning. A water glass and try cocks are near the top. Heating surface in this type of boiler consists of the fire box and the fire tubes up to the water

line; as the water does not completely cover the tubes, the upper part forms a superheater.

When the exhaust steam is released into the stack, the tubes have a tendency to leak. To avoid this, some manufacturers sink the tube sheet below the water level (Fig. 213). This form reduces the superheating surface, and moreover, since the conical smoke chamber is subjected to internal pressure, it is likely to be weak. Fig. 214 is a special type of vertical boiler in which are water tubes laid up in courses. The boiler shell can be removed from the caisson of tubes so that all parts are accessible for cleaning and repairing.

**441. Externally fired boilers** (Fig. 215) are generally of the cylindrical tubular type and can be used for stationary work only. These are probably the most simple as well as most easily handled and kept in repair of all, but they are very bulky, requiring a great amount of floor space. The furnace for such boilers is a part of the setting and is made under the front end. The flames surround the lower part of the shell and pass to the rear, where they enter the tubes and return to the front, thence up the stack.

When setting externally fired boilers, care should be taken that one end or the other, generally the rear, be free to move forward or backward, since the variation of temperature will cause the boiler to contract and expand enough to crack the masonry upon which it rests.

**442. Internally fired boilers.**—This class comprises several types, the locomotive type (Fig. 216), the return-flue type (Fig. 217), and the Lancashire. The first two of these types are the most used for traction or portable work, while the latter is adapted only to stationary use.

**443. Locomotive type.**—The locomotive fire-tube type was probably the first of the modern boilers to come into

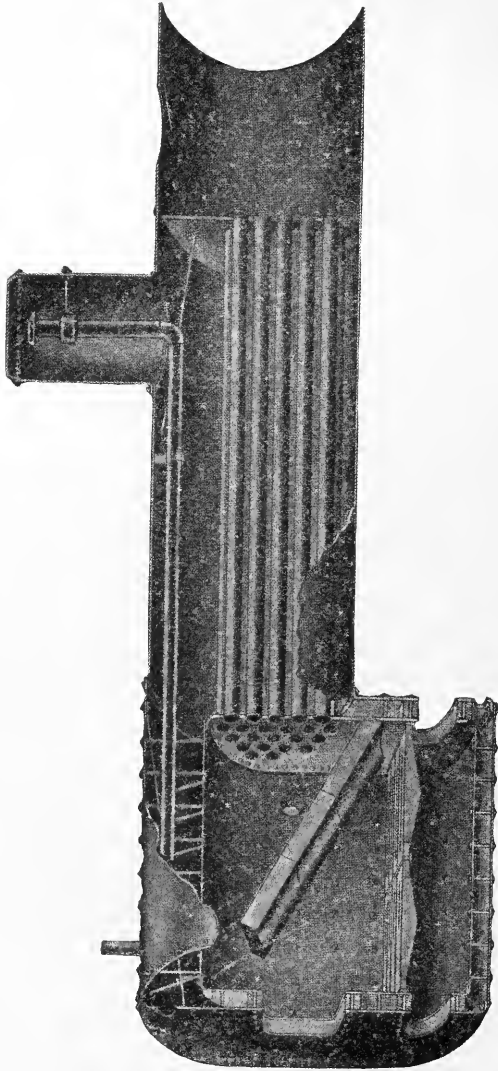

FIG. 216—LOCOMOTIVE TYPE OF INTERNALLY FIRED BOILER



general use. With only a few changes, it is the same now. By referring to Fig. 218, it will be noticed that the fire box is practically built into the rear end of the boiler barrel. Extending from the rear tube sheet and through the entire length of boiler barrel are the fire tubes, which are generally about two inches in diameter. Surrounding the fire box and fire tubes is the water. This gives abundance of heating surface, also freedom of circulation. As the sides of the fire box are nearly flat, they will easily collapse under the pressure of the steam

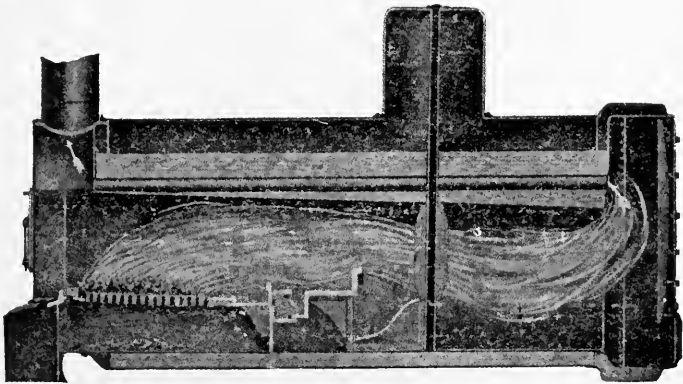

FIG. 217—RETURN-FLUE TYPE OF INTERNALLY FIRED BOILER

unless supported by stay bolts at intervals of every few inches.

The steam dome can be located anywhere, but it is generally placed about midway between front and rear ends. A pipe takes the steam from the top of the dome, carries it down through the steam space, where it is dried, then out wherever convenient.

Generally the blow-off is at the bottom and in front of the fire box. The water glass is placed about on a

level with the crown sheet, since this is the place where the water must not get low.

**444. Round-bottom types.**—The principal variation from the original type of this class of boilers is in the design of the rear or furnace end. The common practice is to have the water pass completely around the fire box, including the under side. Such boilers are generally known as the round- or enclosed-bottom type (Fig. 218). As a rule, the draft can enter at front or rear of the fire box. This method of draft frequently aids the fireman in firing up, for when there is but one ash door the direction of the wind may be such as to blow away from the door, retarding the draft.

**445. The open-bottom type** (Fig. 219) is so constructed that ash pan and grates can be removed and a complete new fire-box lining put in. The draft can enter at either end of the fire box. There is not as free circulation in this type as in the round-bottom boilers, providing the latter are kept clean.

When a portable boiler of the locomotive type is setting with the front end low, unless there is an abundance of water, the crown sheet will be exposed and, if not attended to at once, will become overheated and collapse. To aid in avoiding this, some manufacturers are making the rear end of the crown sheet (Fig. 220) lower than the front. This mode of construction reduces the size of the rear end of the fire box to a certain degree, but it is done where the space is not essential. Fig. 220 also shows a device which further aids in protecting the crown sheet by displacing the water in the front end of the boiler.

**446. Return-flue boilers** of the internally fired type have one main flue, which carries the gases from the fire box through the boiler to the front end. Here they

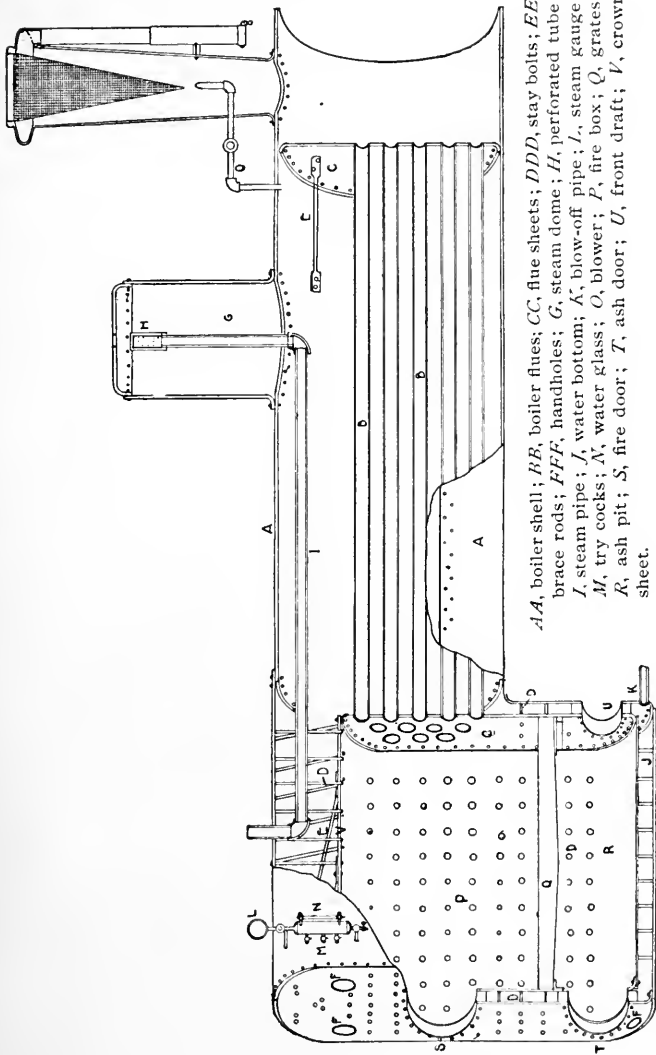

AA, boiler shell; BB, boiler flues; CC, flue sheets; DD, stay bolts; EE, brace rods; FF, handholes; G, steam dome; H, perforated tube; I, steam pipe; J, water bottom; K, blow-off pipe; L, steam gauge; M, try cocks; N, water glass; O, blower; P, fire box; Q, grates; R, ash pit; S, fire door; T, ash door; U, front draft; V, crown sheet.

FIG. 218—SECTIONAL VIEW OF LOCOMOTIVE TYPE OF INTERNALLY FIRED BOILER

are divided and enter several smaller flues, then return to the rear end and pass up the stack. This, without doubt, is a very economical type.

By referring to Fig. 221, which is an end view of a return-flue boiler, it will be noticed that the smaller tubes are above the main flue. By this arrangement the smaller and cooler parts will become exposed first, thus giving

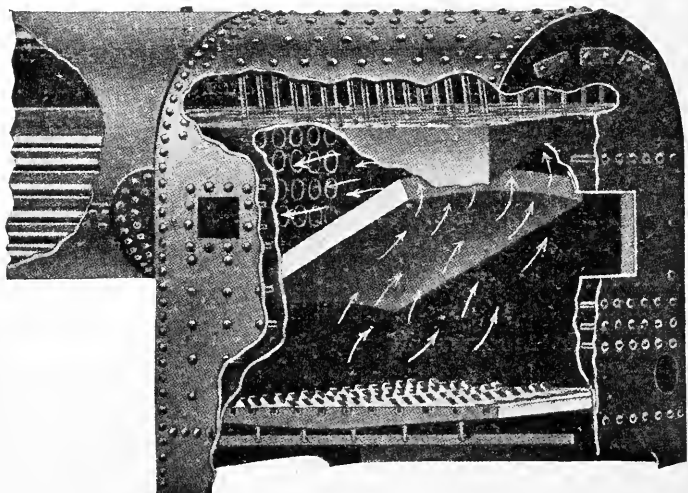

FIG. 219—OPEN-BOTTOM FIRE-BOX BOILER

the engineer a chance to save the boiler from collapse or explosion.

**447. Wood and cob burners.**—Most boilers upon the market have interchangeable grates so that by placing a grate with smaller openings in place of the coarser one for coal, wood and cobs may be burned.

Since the most economical firing can be accomplished by refraining from poking the fire on top, a great many factories are making a rocker grate (Fig. 222), which is

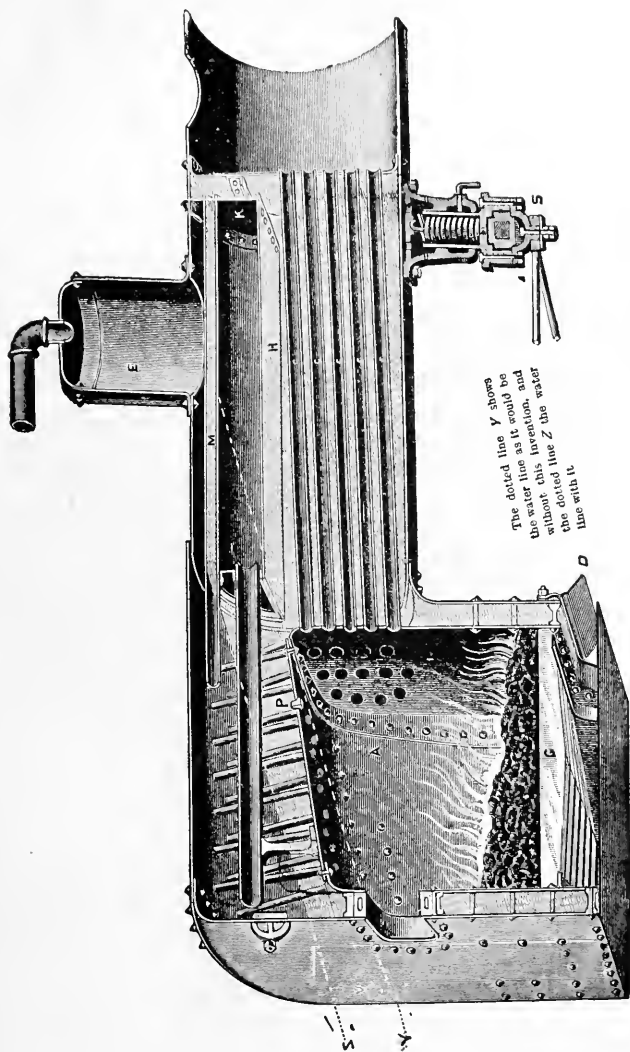

FIG. 220—BOILER WITH REAR END OF CROWN SHEET LOWER THAN FRONT END

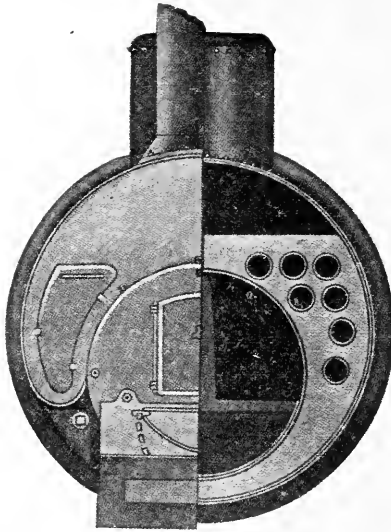

FIG. 221.—END VIEW OF RETURN-FLUE BOILER

worked by a lever in such a manner that all fine ashes will drop through.

#### 448. Straw burners.—

For burning straw there must be special arrangements within the fire box. The fuel is light and generally chaffy, and as a result flashes up very quickly, and unless prevented will be carried by the draft some distance through the tubes before it is all aflame. Not only this, but straw must be burned rapidly in order

to produce heat enough to make steam as fast as needed. To handle straw under these conditions, the return-flue boilers are generally constructed similar to the type shown in Fig. 223: *a* is an extended fire box with a drop-hinge door; *b* is the upper grate; and *c* is the lower grate, where as much of the straw as is not burned in the upper grate, or as it falls from it, is consumed; *d d* are deflectors which hold the flames next to the upper side of the flue.

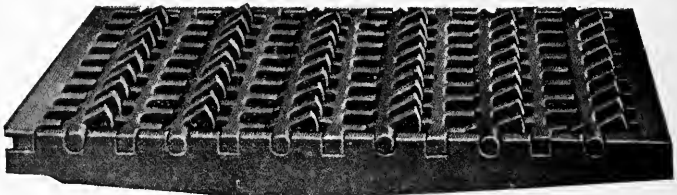

FIG. 222.—ROCKER GRATES

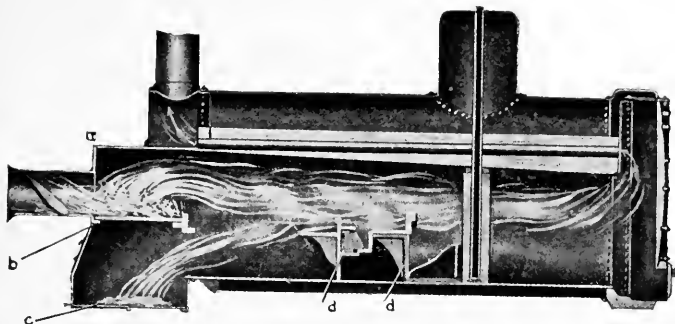

FIG. 223.—STRAW BURNER RETURN-FLUE BOILER

449. Direct-flue boilers, (Fig. 224), can be more easily changed from coal burners to straw burners. This is generally done by adding a feeding tube with an enclosed drop-hinge door, by removing the grates and inserting a dead plate with short grates in front of it, and by placing a deflecting arch composed of firebrick in the fire box.

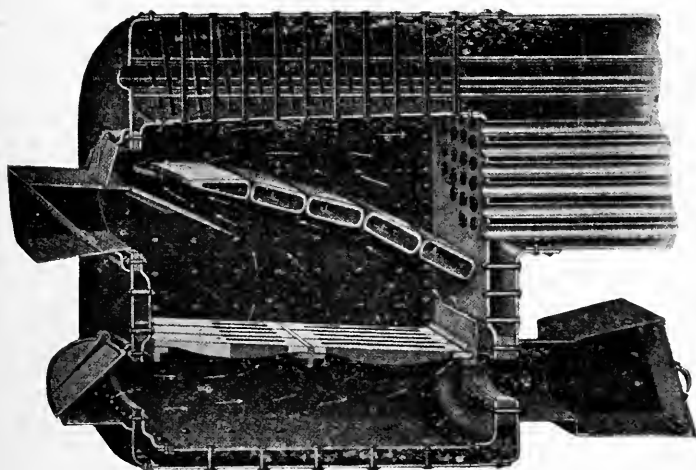

FIG. 224.—STRAW BURNER DIRECT-FLUE BOILER

By means of the shorter grates the draft opening is reduced, and by the aid of the deflector a combustion chamber is produced where all of the light particles are consumed and the gases are heated to an incandescent state before entering the tubes. The direction of draft in this type is nearly always toward the straw, thus causing the heat as it passes the unburned straw to prepare it for better combustion.

### BOILER ACCESSORIES

**450. Supply tank.**—Boilers used for traction purposes require a small supply tank to which the boiler pump or the injector is connected. This tank is generally placed in some position where it is convenient, yet out of the way.

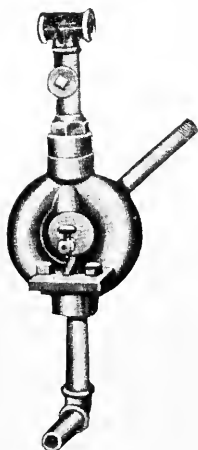

FIG. 225—SYPHON  
FOR FILLING SUP-  
PLY TANK

**451. Siphon or ejector.**—When the supply tank is placed so high that it cannot be filled from a stock tank or other similar source, a siphon (Fig. 225) is generally used. The construction of this is such that a jet of steam is passed into a water pipe leading from the tank or cistern to the supply tank. As the steam comes in contact with the water

it is condensed; this produces a vacuum such that the water rushes in to fill, and the inertia due to the velocity of the steam sends it along into the supply tank.

Care must be taken in regard to the amount of steam used, since if too much steam be used the water will become so warm that the feed pump or injector will not work.

**452. Feed pumps.**—There are three types of pumps now in use: the crosshead pump, the independent direct-



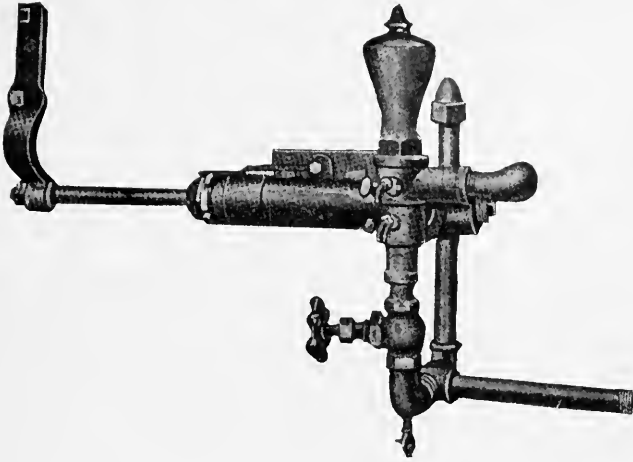

FIG. 226—CROSSHEAD PUMP

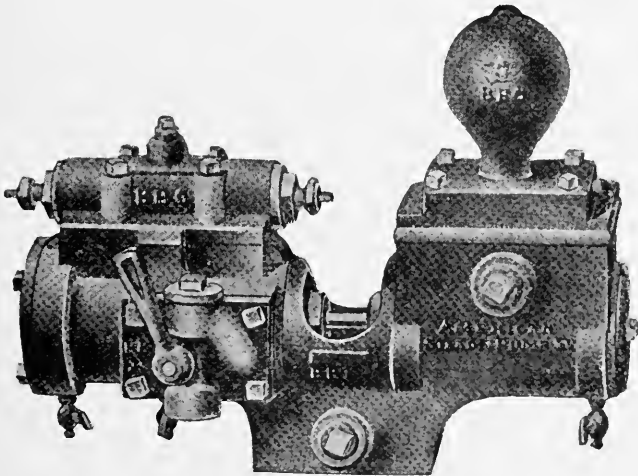

FIG. 227—INDEPENDENT DIRECT-ACTING PUMP

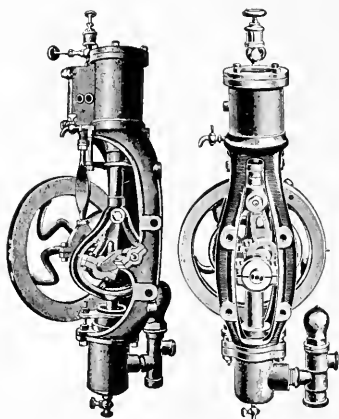

FIG. 228—INDEPENDENT PLUNGER PUMP

can be run at any time and by any one. The initial cost of this is more than that of other types.

453. The injector is probably the most generally used means of feeding boilers. It was invented in 1858 by M. Giffard, and large numbers of the same types are still made. The action of the injector will be understood by referring to the sketch (Fig. 229). Steam is taken from the boiler and passes through the nozzle *A* to the injector; the amount of steam is

acting (Marsh) pump, and the independent plunger pump (Figs. 226, 227, and 228). The crosshead type is the simplest and most economical, but can be run only when the engine is running. The Marsh independent pump is simple and economical, but the action of its steam valve is delicate and should be molested only by an expert. The independent plunger pump is very satisfactory in that it

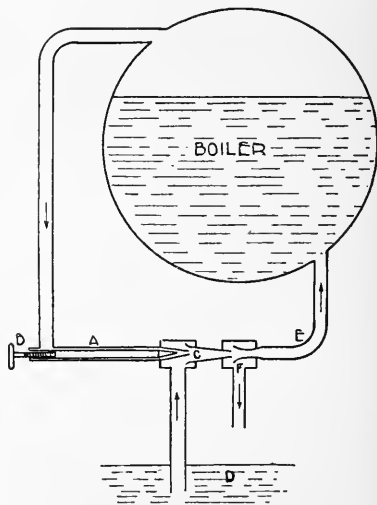

FIG. 229—PRINCIPLE OF THE INJECTOR

regulated by the valve *B*. In the tube *C* the steam is combined with the slowly moving water, which is drawn up from the tank *D*. The swiftly flowing steam puts sufficient momentum into the water to carry it into the boiler. The delivery tube *E* has a break in it at *F* where the surplus steam or water can overflow.

An injector should be chosen with reference to the special work required of it. Some will lift water, others will not. Some will start under low-pressure steam and

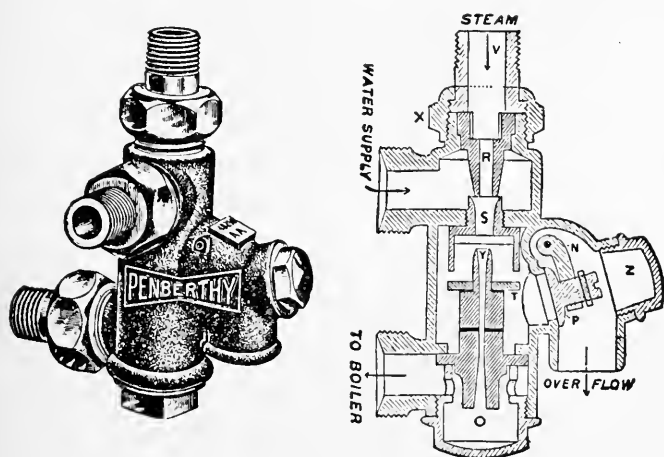

FIG. 230—COMMERCIAL INJECTOR

refuse to act under high, while with others the reverse is true. There are also injectors which will operate with exhaust steam. Such an injector is not essential, since the efficiency of one of high pressure is practically 100 per cent.

Locomotives are equipped with self-starting injectors.

Every traction engine should be equipped with two systems of boiler feeds. Some have two injectors, while

some have two pumps, but the most common method is a pump and injector.

**454. Feed-water heaters.**—The sudden change in temperature of boilers puts them under a great deal of strain. One of the principal reasons for this change in temperature is the admitting of cold feed water. This water may be easily heated by passing the exhaust steam through it. There are two methods of such heating: one is to allow the exhaust steam to mingle with the water, thus being condensed and carried back to the boiler, and the other is to pass the feed water through pipes surrounded by steam. By the former method the steam is returned

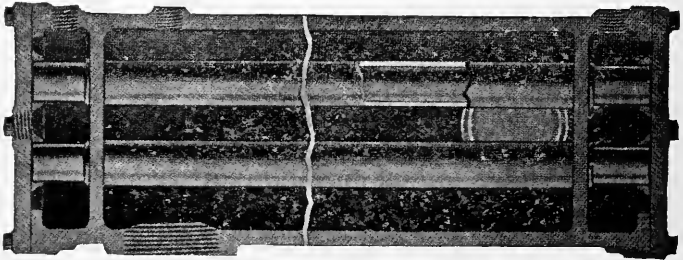

FIG. 231—FEED-WATER HEATER

to the boiler, and unless a filter is used all the cylinder oil is carried into the boiler, to which it is detrimental. In the latter case the steam does not return to the boiler, but is sent up the stack, thus producing a forced draft. Fig. 231 shows a heater of this type.

As pumps and injectors will not operate with hot water, and since the water from a heater is nearly as hot as the exhaust steam, the heater must be located between pump and boiler.

**455. Water columns.**—The purpose of the water column is to support the gauge glass and try cocks; it is

used only in stationary boilers. The water column should be located so that the center of the column will come to the point where the level of the water should be above the tubes, or crown sheet. The column is generally of a casting about  $3\frac{1}{2}$  inches in diameter and 15 inches long. Into this casting are secured the try cocks and water glass. Some builders connect the steam gauge to the upper end.

By referring to Fig. 232 it will be noticed that the lower end of the glass, the lower try cock, and the crown sheet are on a level with each other, hence when the water is out of sight in the glass and also will not flow from the try cock the crown sheet is exposed. The water should be kept about in the middle of the glass, and likewise even with the center try cock. It should not be above the upper try cock, or there will be trouble from wet steam.

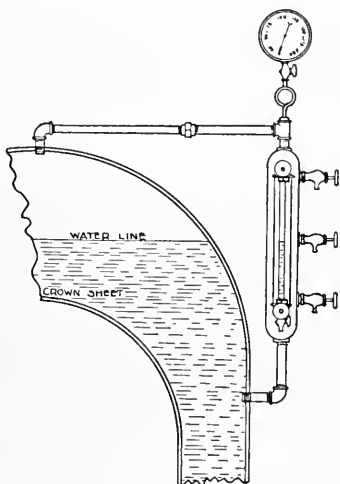

FIG. 232—WATER COLUMN,  
GAUGE GLASS, TRY COCKS  
AND STEAM GAUGE

**456. Steam gauge.**—The mechanism of a steam gauge (Fig. 233) usually consists of a thin tube bent in a circle. One end of the tube is connected to the boiler, and the other, by means of a link, to a small pinion which works a needle indicator. Air is kept in the tube by means of the siphon, and a cylinder of water lies between the air and the boiler. When there is zero pressure in the boiler the needle should set at 0. As pressure begins to rise in the

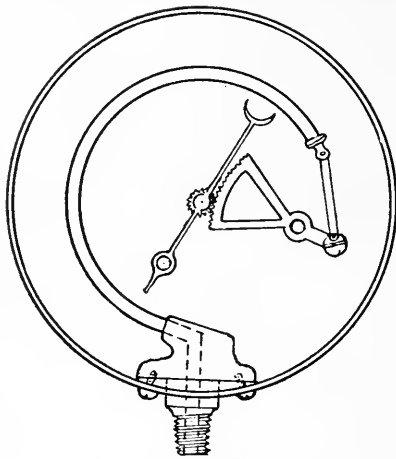

FIG. 233—STEAM GAUGE

boiler the air will tend to straighten the tube, and hence the tube acts upon the needle. If it is found by comparison with another gauge that the needle does not indicate the actual steam pressure it can be regulated by sliding the link up or down in the slot at the end of the pinion, thus changing the throw of the needle.

#### 457. Fusible plug. —

As a safeguard against low water a fusible plug is put in the boiler. In fire-box boilers it is placed in the crown sheet directly over the fire, and in return-flue boilers it is placed in the back end just above the upper row of flues. The plug is generally made of brass about one inch in diameter and with a tapered hole bored through its center (Fig. 254). The tapered hole is filled with some metal, generally Banca tin, which will fuse at a low temperature, so that when the water has become so low that the metal melts and runs out the steam will flow through the opening and put out the fire.

**458. Safety or pop valve.**—It is essential that in every boiler there be a safety valve so that the steam may be released before too high pressure has been reached. There are two distinct types of these valves, the ball and lever valve and the spring pop valve. The former (Fig. 235) is

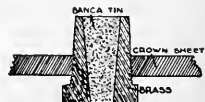

FIG. 234—FUSIBLE PLUG

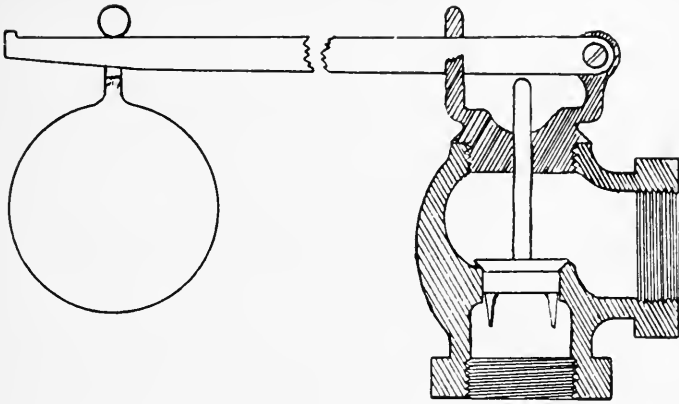

FIG. 235—BALL AND LEVER SAFETY VALVE

the least expensive, also the less reliable. It is generally used upon stationary boilers. To increase the pressure in the boiler before it blows off, the ball must be moved farther out on the lever, and inversely to decrease the pressure. The ball should be set at the proper point to blow off at the desired pressure, and then the lever marked so that the point can be seen distinctly.

Spring safety valves are generally used on traction engines and the better class of boilers. They are more reliable and also act much more quickly. If properly constructed they will allow the pressure to fall about 5 pounds before closing, while the ball and lever type only falls to a trifle less than the blow-off pressure. By referring to Fig. 236

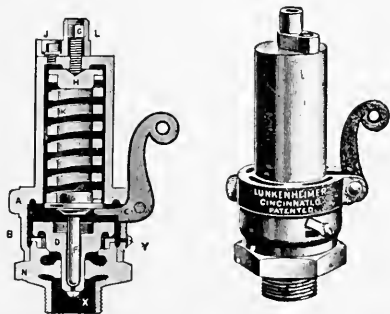

FIG. 236—POP VALVE

it will be noticed that there is a groove *B* in the valve such that when the valve starts to open, the steam rushes into it, thus increasing the area of the valve and causing it to open more quickly and remain open longer. To increase the pressure at blow-off, screw down on the pin *G*; to lower the pressure, screw up on the pin *G*. Care must be taken not to tighten the spring down too far, or it will not allow the valve to lift off its seat.

**459. Blower and exhaust nozzle.**—In all traction engines there must be some method of increasing the draft. The most simple method and the one universally used is the blower when the engine is not running, and the exhaust when it is.

The blower (Fig. 218) consists of a small pipe with a

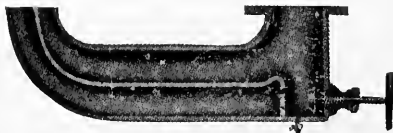

FIG. 237—EXHAUST NOZZLE

valve which leads from the boiler to the stack.

After the pressure has reached 5 or 10 pounds the valve in this pipe is opened and a jet of steam is allowed to

blow into the stack. The momentum of the steam produces a vacuum and the air rushing through the grates and coal to fill this space increases the rate of combustion. When the engine is running the exhaust steam from the heater takes the place of the blower and the latter is closed. Fig. 237 shows an exhaust nozzle which can be made to give a sharp or sluggish exhaust, as desired.

**460. Blow-off pipe.**—Wherever there is a chance for sediment of any kind to collect in a boiler there should be some means of cleaning it. This is almost always accomplished by means of a blow-off pipe and valve. In vertical boilers this is located at the lower end of the water leg. In return-flue boilers this is either at the front



or the rear end, and in fire-box boilers it is beneath the fire box or in the water legs.

**461. Spark arrester.**—Where some method of forced draft is used in a boiler there is danger of sparks being carried out and causing fires. Traction engines guard against this by means of a spark arrester. This may consist of a screen which catches the sparks and allows them to fall into the stack, or it may be accomplished by turning the smoke around a sharp corner and, as the sparks are heavier than the smoke, they will be thrown out and are caught in a receptacle for that purpose. The smoke box or front end of the boiler may be long for the purpose.

### BOILER CAPACITY

**462.** The **capacity** of a boiler depends upon the amount of heat generated and the proportion of that heat transferred to the water. The amount of heat generated depends upon the quantity of coal, the draft, and area of grate surface. The amount of heat transferred from the coal to the water depends upon the amount and position of the heating surface.

There is no entirely satisfactory method of stating the capacity of a boiler or its economy, but they are commonly stated as **boiler horse power** and the pounds of steam evaporated per pound of coal. This method of rating is on the assumption that the steam is all dry saturated steam and that there is no priming or superheating.

When water is carried along with steam from the boiler it is called **priming**. Very seldom is a boiler designed which does not prime at least 2 per cent, but if it primes over 3 per cent it is improperly designed. When steam passes over a hot surface after leaving the boiler it will absorb additional heat and become superheated. That

part of the tubes which is above the water line in a vertical boiler is superheating surface. In other styles of boilers the steam in order to be superheated generally passes through a coil of pipe within the fire box or a furnace made purposely for it.

**463. Steam space.**—The surface for the disengagement of steam and the steam space should be of sufficient size so that there is no tendency for the water to pass off with the steam. It has been found by experiment that if the steam space has capacity to supply the engine with steam for 20 seconds, there will be no trouble with priming. To determine whether the boiler has sufficient steam space, find the volumes of the engine cylinder, less the volume of the piston, and multiply this by twice the number of revolutions that the engine makes in 20 seconds. This should be about equal to the volume of the steam space, which is the space above the water in the boiler, plus that in the dome.

**464. Boiler horse power.**—There are two common methods of approximately determining the horse power of a boiler, and a third one which is sometimes resorted to. One of the common methods is by test, and the other is by heating surface, while the third method is by grate surface.

**465. Horse power by test.**—A committee of the American Society of Mechanical Engineers has recommended that one horse power be equivalent to evaporating 30 pounds of water at 100° F. under a pressure of 70 pounds gauge. This is equivalent to 33,320 B.T.U. an hour.

**Example.**—If a 15 H.P. boiler evaporate  $15 \times 30$  or 450 pounds of water in one hour with feed water at 100° and under a gauge pressure of 70 pounds, it would be doing its rated horse power. To make the test, fill the boiler to its proper level and tie a string around the glass at this point, then keep the water in the boiler at this level. If the feed water is below 100°, turn steam into it until

the proper temperature has been reached. Use just steam enough to keep the pressure at 70 pounds. Weigh the feed water supply before starting, then weigh again at the close of the run. If the run has been of one hour's duration, divide the number of pounds of feed water by 30, and this will give the horse power developed. If the run has been only one-half hour, multiply by 2, then divide by 30.

**466. Power by heating surface.**—The heating surface of a boiler consists of the entire area of those parts of the surface which have fire on one side and water on the other. In the horizontal tubular boiler it is all of the shell which comes beneath the boiler arch, also the inside area of all the tubes and about two-thirds the area of the tube sheets less the area of the flues. In the vertical boilers it is the total inside area of the fire box and as much of the tubes as is below the water line.

In the fire-box boilers it is the inside area of the water legs, the crown sheet, and the flues and a portion of the tube sheets.

The common rating of boiler horse power by heating surface is 14 square feet for each horse power. This varies with the boiler, some styles requiring a little less and some a little more.

As an example, let it be desired to find the heating surface of a horizontal tubular boiler. Find the total area of the outside of shell and take about one-half of this. The brickwork covers about one-half of the shell, hence, one-half of it is all the heating surface there is in this part. Now measure and compute the inside area of one of the flues and multiply this by the number of flues. Add this surface to the heating surface of the shell and divide the sum by 14. This gives the horse power of the boiler.

**467. Power by grate surface.**—This method is not very often resorted to. In any case it can be only a rough

estimate. It is generally conceded that from one-third to one-half square feet of grate surface is equivalent to one horse power.

### STRENGTH OF BOILERS

**468. Materials used.**—The materials used in the construction of boilers are mild steel, wrought iron, cast iron, copper, and brass.

In order that a boiler have proper strength for the severe work required of it, sample pieces of all the materials used in its construction are selected and given a test, and those which fail to have the proper requirements are discarded. They are tested in tension, compression, and shear. (See Chap. III, Part I.)

*Steel.*—All present-day boilers are made up of mild-steel plates. This steel is a tough, ductile, ingot metal, with about one-quarter of 1 per cent of carbon. It should have a tensile strength of about 55,000-60,000 pounds. Sometimes a better grade of steel plate is used for the fire box and tube sheets of the boiler than for the shell. This is because flanging for riveting and the variations of temperature due to the fire require a better grade of steel.

*Blue heat.*—All forms of mild steel are very brittle when at a temperature corresponding to a blue heat. Plates that will bend double when cold or at a red heat will crack if bent at a blue heat.

*Wrought-iron parts.*—All welded rods and stays should be of wrought iron. About 35 per cent of the strength of the bar is lost because of the weld. Boiler plates made of wrought iron are considered more satisfactory than of steel, but are used only in exceptional cases because of the greater cost. Wrought-iron plates should have a tensile strength of 45,000, and bolts should have 48,000.

*Rivets.*—Boiler rivets are either of wrought iron or mild steel. The rods from which rivets are made should have a

tensile strength of 55,000 pounds for steel and 48,000 for iron. When cold they should bend around a rod of their own diameter, and when warm bend double without a fracture. The shearing strength is about two-thirds of the tensile strength.

*Cast iron* is used in boilers for those parts where there are no sudden changes of temperature and where there is no great tensile strength required. Couplings, elbows, etc., are better of cast iron, for when they become set and can be removed in no other way they can be broken.

**469. Stay bolts and stay rods.**—In some parts of the boilers the flues act as stays. In horizontal tubular boilers the flues hold the ends of the shell together. In the fire box and in vertical boilers they act in the same way between the flue sheets. Wherever there are flat surfaces and no other means of supporting them, special stay bolts or braces must be put in. In nearly all boilers above the flues stay rods are used to support the ends. Around the fire box stay bolts are put in. These bolts are threaded full length, then screwed through the outer shell and through the water leg and into the fire-box lining, then they are riveted on both ends. Their size and distance apart depends upon the pressure to be carried.

**Example.**—If the stay bolts are 4 inches apart and the maximum pressure to be carried is 120 pounds they should be large enough to hold

$$4 \times 4 \times 120 = 1,920$$

pounds. If we use a factor of safety of 10—that is, make it ten times as strong as necessary to avoid accidents—it will have to be large enough at the base of the thread to hold

$$1,920 \times 10 = 19,200$$

pounds. If a wrought-iron bolt is used it would have to have

$$19,200 \div 48,000 = 0.40$$

square inches area at the base of threads. A  $\frac{3}{4}$ -inch bolt has about this area.

**470. Strength of boiler shell.**—To determine the tension upon one side of a boiler shell, let

$p$  = pressure in pounds per square inch,

$t$  = thickness in inches,

$r$  = radius,

$s$  = stress in pounds per square inch;

then

$$s = \frac{pr}{t}.$$

**Example.**—A boiler has a diameter of 3 feet, a thickness of  $\frac{7}{16}$  inch and the steam pressure is 125 pounds. How many pounds per square inch pull is there on each side?

$$s = \frac{pr}{t} = \frac{125 \times 3 \times 12}{2} \div \frac{7}{16} = 5,143$$

pounds. This is about one-tenth the tension which boiler plate will stand, hence we have a factor of safety of 10, which is greater than need be.

**471. Riveted joints.**—If a boiler shell could be made of one continuous piece, the above tension would be the safe working load, but since the steel has to be riveted and a riveted joint is not as strong as the original plate, we must consider the ratio of this strength of the whole plate. This ratio is commonly called the efficiency of a riveted joint.

There are three general ways that a riveted joint may give way:

1. By tearing the plate between the rivets.
2. By shearing the rivets.
3. By crushing the rivets or plate at the point of contact.

Since only single-riveted and double-riveted lap joints are used in small boilers, these styles will be considered only.

**472. Single-riveted lap joint.**—In the joint shown by Fig. 238, let  $t$  be the thickness of plate,  $d$  the diameter of rivet,  $p$  the distance between rivets, commonly called pitch, the tensile strength

of the plate  $S_t = 45,000$ , and resistance to crushing  $S_c = 90,000$ . Assume  $t = 7/16$  inch,  $d = 1$  inch, and  $p = 2\frac{1}{2}$  inches.

A strip of the joint equal in width to the pitch is sufficient to be considered.

**1. Tearing between the two rivets.**—In this case there is a strip to be torn in two, equal in width to the distance between the rivets less the diameter of the rivet, i.e.,  $p - d$ , and it has a thickness equal to  $t$ , i.e., the strip has a cross-section of an area  $(p - d)t$ ; this cross-section in square inches times the tensile strength will give the pull required to fracture the joint :

$$(p - d)tS_t = (2\frac{1}{2} - 1) \times 7/16 \times 55,000 = 36,095.$$

**2. Shearing one rivet.**—Since there is only one rivet in each  $2\frac{1}{2}$ -inch strip, we have to consider the shearing of it only.

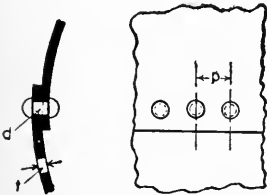

FIG. 238—SINGLE-RIVETED LAP JOINT

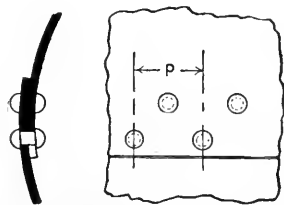

FIG. 239—DOUBLE-RIVETED LAP JOINT

The area to be sheared is the area of a cross-section of the rivet, or

$$\frac{3.1416 d^2}{4}.$$

The pull which it will take to shear this rivet is the area times the shearing strength:

$$\frac{3.1416 d^2}{4} \times S_s = \frac{3.1416}{4} \times 45,000 = 35,343.$$

**3. Crushing.**—In this case it is common to consider that the area to be crushed is the diameter of the rivet times the thickness, hence

$$dtS_c = 1 \times 7/16 \times 90,000 = 39,375.$$

The number of pounds it will take to fracture a strip of plate  $2\frac{1}{2}$  inches wide and  $7/16$  inch thick by tension is

$$2\frac{1}{2} \times 7/16 \times 55,000 = 60,155.$$

Hence the ratio of the strength of the joint to the strength of the plate is

$$35,350 \div 60,155 = .588;$$

hence

$$0.588 \times 100 = 58.8 \text{ per cent} = \text{the efficiency.}$$

Now, if the original shell on page 344 is referred to, it will be seen that instead of having a boiler with a factor of safety of 10 it will have only 58.8 per cent of this factor, or approximately 6, which is about the usual factor.

### 473. Double-riveted lap joint (Fig. 239).

1. **Tearing between two rivets.**—The resistance to tearing is

$$(p - d)tS_t = (2\frac{1}{2} - 1) \times 7/16 \times 55,000 = 36,095.$$

2. **Shearing two rivets.**—Instead of shearing one rivet as in the single-riveted lap joint, two are sheared. Hence

$$\frac{2 \times 3.1416 d^2}{4} \times S_s = \frac{2 \times 3.1416 \times 1 \times 1}{4} \times 45,000$$

is equal to 70,686.

3. **Crushing two rivets.**—Here again two rivets are considered instead of one, hence

$$2dtS_c = 78,750.$$

The efficiency of this joint would then be

$$100 \times 36,095 \div 60,155 = 60 \text{ per cent.}$$

The same dimensions have been used in this joint as in the previous one for simplicity and comparison. By using a smaller rivet this joint can be made much more efficient.

474. **Test of boilers for strength.**—There are two distinct methods of testing boilers for strength. The one which is generally conceded to be best is the hydraulic test; and the other, which is about as safe and sure, and in some cases more so, is the hammer test.

*Hydraulic test.*—This test consists in filling the boiler full of cold water and then putting pressure upon it to the desired point. This pressure is generally about one and one-half times the working pressure. Since some boilers are designed with a factor of safety of only four or five, if twice the working pressure be put on it there will be danger of rupture to the boiler. With new boilers this



test shows all leaks around stays, tubes, joints, etc.; while in old boilers, if they are carefully watched as the pressure increases, it will disclose weakness by bulging in some places and distortion of joints in others.

*Hammer test.*—The inspector who conducts this test should go over the boiler before it has been cleaned inside and out and carefully note all places where there is corrosion or incrustation. At the same time he should carefully strike all suspicious places a sharp blow with the hammer to detect weaknesses. A good plate will give a clean ring at every blow of the hammer, while a weak one has a duller sound.

Although a boiler may be carefully inspected and tested by both methods, it does not insure it against failures. The greatest strain upon a boiler is due to unequal expansion, and neither of these methods takes this into account.

Some authorities recommend hot water to be used in the test, but there seems to be no advantage in this, since it is the unequal expansion of boilers and not the rise in temperature which causes the failure of certain parts and consequently so much destruction.

## FUELS

**475.** The fuels most commonly used for making steam are coal, coke, wood, peat, gas, oil, bogasse, and straw. Those used for traction engines and threshing purposes are coal, wood, straw, and occasionally cobs.

*Anthracite coal.*—Anthracite coal, commonly known as hard coal, consists almost entirely of carbon. It is hard, lustrous, and compact, burns with very little flame, and gives an intense heat. It has the disadvantage when being fired of breaking into small pieces and falling through the grates.

*Semi-anthracite coal.*—This variety has properties that make it to be considered a medium between anthracite and soft coal. It burns very freely with a short flame.

*Bituminous or soft coals.*—These burn freely and with all gradations of character. Their properties are so varied that they will not permit of classification. Some burn with very little smoke and no coking. This class is generally used in traction engines. Others which coke very freely are good for gas making.

*Wood* is used only where it is more plentiful than coal. It requires a finer meshed grate than coal and more attention in feeding.

*Oil.*—In localities where oil is plentiful or where it is cheaper to freight oil than coal, furnaces are fitted for it as a fuel. It has been found that oil burns the best when atomized and mixed with steam. For this purpose a nozzle is constructed so that both steam and oil can flow from it, the steam forming an oily vapor of the oil, which when ignited burns with a very intense heat.

*Straw.*—In localities where straw is practically worthless and coal and wood are scarce, straw is used as a fuel. It must be handled with care, since too much in the fire box at once is as harmful as not enough.

**476. Value of fuels.**—Anthracite and semi-anthracite coals have about the same heating value. Bituminous has a trifle lower value. A cord of hard wood has the same amount of heat in it as a ton of anthracite coal, while a cord of soft wood has only about half that value.

## COMBUSTION

**477.** The term **combustion** as ordinarily used means the combining of a substance in the shape of fuel with oxygen of the air rapidly enough to generate heat. In all fuels there are hydrogen and carbon, and some mineral matter.

The carbon and hydrogen unite readily with the oxygen of the air, generating heat and light, but the mineral matter remains and forms the ash.

When the carbon of the coal mixes with the oxygen of the air and the mixture is at or above the igniting temperature, combustion takes place and either carbon monoxide (CO) or carbon dioxide (CO<sub>2</sub>) is formed, depending upon the amount of air supplied. If the air is insufficient in quantity to furnish enough oxygen to form CO<sub>2</sub>, CO will be formed. If the mixture is not hot enough to form complete ignition a great deal of free carbon in the form of smoke is thrown off and is a loss.

**478. Heat of combustion.**—Carbon will not unite with oxygen when in the free state until a certain temperature is reached. This temperature is known as the igniting temperature. When the igniting temperature has once been reached and the carbon of the fuel combines with the oxygen of the air, they in turn throw off heat. By experiment it has been found that one pound of carbon burned to carbon monoxide (CO) produces 4,400 B.T.U., and if burned to carbon dioxide (CO<sub>2</sub>) 14,650 B.T.U. are produced. One pound of hydrogen united with sufficient oxygen produces 62,100 B.T.U.

**479. Air for combustion.\***—By weight, 12 pounds of carbon unite with 16 pounds of oxygen; hence 1 pound of carbon forms

$$28 \div 12 = 2\frac{1}{3}$$

pounds CO, or if it be burned to CO<sub>2</sub> it will require twice as much oxygen for each pound of carbon; hence

$$12 + (2 \times 16) \div 12 = 3\frac{2}{3}$$

pounds CO<sub>2</sub> for each pound of carbon.

Since in the  $3\frac{2}{3}$  pounds CO<sub>2</sub> there is one pound of

\*A good discussion of this will be found in Peabody and Miller's "Steam Boilers."

carbon, there must be  $2\frac{2}{3}$  pounds of oxygen; hence one pound of carbon requires  $2\frac{2}{3}$  pounds of oxygen. As we must have  $4\frac{1}{2}$  pounds of air to get one pound of oxygen to burn one pound of carbon to  $\text{CO}_2$ , it requires pounds of air.

$$2\frac{2}{3} \times 4\frac{1}{2} = 12$$

As there are impurities in all fuels, so that a pound of fuel is not necessarily a pound of pure carbon, there are variations which have to be considered.

**480. Volume of air for combustion.**—As before stated, an insufficient amount of air burns the carbon only to  $\text{CO}$ , while a sufficient amount burns it to  $\text{CO}_2$ . Instead of having the exact 12 pounds of air for each pound of carbon, as previously computed, it requires an excess for complete combustion. This excess varies from one-half the quantity required for combustion to an equal quantity. Roughly, for each pound of carbon there should be from 18 to 24 pounds of air.

By experiment it has been found that it requires 10 pounds of air for each pound of certain coals, and since 13 cubic feet of air at the temperature it generally enters the fire box weighs 1 pound, for each pound of coal it requires

$$10 \times 13 = 130$$

cubic feet of air without excess. If the excess is 50 per cent, it requires about 200 cubic feet.

*Loss from improper amount of air.*—If one pound of carbon be burned to  $\text{CO}$ , there will be 4,400 B.T.U. liberated. If it be burned to  $\text{CO}_2$ , there will be 14,650 B.T.U. set free. Hence there will be a loss of

$$\text{or } 14,650 - 4,400 = 10,250 \text{ B. T. U.}$$

$$100 \times 10,250 \div 14,650 = 70 \text{ per cent.}$$

This would be a case too rare to be considered and is used only for simplicity. If due caution is practiced in

regard to handling drafts, there is very seldom a loss of over 5 to 8 per cent due to lack of air.

On the other hand, if there be too great an excess of air, it would not only furnish oxygen for combustion in sufficient quantities, but the excess would be heated as it passes through the boiler from a temperature of the outside air to a temperature of the flue gases, thus taking up part of the heat which would be transferred to the water. This loss generally amounts to from 4 to 10 per cent.

**481. Smoke prevention.**—Black smoke is caused by incomplete combustion. It is generally noticed when starting a fire or when fresh coal is put on. To avoid as much of this as possible, keep the fire hot and feed the coal in small quantities. Do not have the door open longer than is absolutely necessary, as the excess of air cools the fire and instead of burning the CO to CO<sub>2</sub>, it passes off as CO or free carbon, which causes the smoke.

#### HANDLING A BOILER

**482. The flues** are made of a soft, tough iron or steel. They are put in place, then expanded with a tube ex-



FIG. 240—FLUE EXPANDED WITH PROSSER EXPANDER

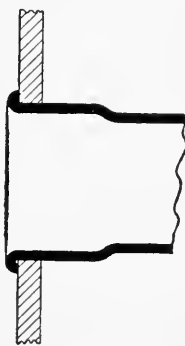

FIG. 241—FLUE EXPANDED WITH DUDGEON EXPANDER

pander to a steam-tight joint. The Prosser and Dudgeon expanders are the two types in common use.

The Prosser makes a shoulder on the inside of the sheet as well as on the outside, but permits the tubes to touch only at the outer edges (Fig. 240), while the Dudgeon expander enlarges the end of the tube and causes it to fit the full thickness of the sheet (Fig. 241). Owing to the construction of this type of expander, it is preferable for repair work.

**483. Manholes and handholes.**—These are openings in the boiler to permit of cleaning and examining. The use of a manhole is confined to stationary boilers and is generally placed near the top in an opening about  $11 \times 15$  inches. Handholes are generally in the water legs or near the bottom of the boiler. Their accustomed size is about  $3 \times 5$  inches. The plate used to cover these holes is held in place by a bolt passing through a yoke. To secure a tight joint, a  $\frac{1}{8}$ -inch gasket is placed between the plate and the boiler shell of the handholes. The same style of gasket is used for the manholes, but it should be about  $\frac{1}{4}$  inch thick.

**484. Safety valves and steam gauges.**—The safety valve should be placed in a pipe by itself, and this pipe should be inspected often for stoppages, etc. The safety valve and steam gauge should be set for the same pressures; that is, if the valve blows off at 110 pounds, the gauge should not read 100 or 120. In case this should happen, do not set the valve to blow off according to the gauge until the gauge has been tested by some gauge known to be correct. During freezing weather the gauge should be taken off every night and put where it will not freeze. Every morning before starting up the safety valve should be tried to see that it neither leaks nor sticks.

**485. Water glass.**—There is a cock at each end of the

glass tube. When these cocks are both open the water will pass from the boiler into the glass and stand at the same level as in the boiler, but if either one of the cocks be closed or the pipes leading to the cocks be stopped, the water would rise in the glass and give a false water level. If it is the upper one that is closed, the pressure in the boiler will cause the glass to fill, and if the lower one is closed, the glass will fill with condensed steam. Below this glass is another cock, which is used to drain the glass or blow out the other cocks. By opening this cock when there is pressure and closing the lower one leading to the glass, the upper one will blow out, or if the upper one is closed and the lower opened it will blow out. It is best to try the cocks every morning and see if they are open or free from stoppage. Always have some extra glasses along, for they are likely to break at any time.

**486. Leveling the water column.**—Before firing up a boiler a new man should always determine the level of his water in the boiler as compared to the water column. If it is a stationary boiler, take off the manhole cover and fill until the water has reached the lowest limit in the glass. Then continue to fill until the proper height of water has been reached and again note the level in the glass. A good way to mark these points is to file notches in the guard wires which protect the glass.

Should the boiler be traction or portable, it should be set on level ground and leveled up with a level. Then the water column should be leveled the same as in a stationary boiler.

**487. Feed pipe.**—There is difference of opinion in regard to the place where the feed pipe should enter the boiler. In horizontal tubular boilers it generally enters near the front end and passes back through the boiler to

near the back end before it discharges. In this way the feed water reaches nearly the temperature of the boiler water before it comes in contact with the shell or the tubes. In threshing boilers it generally enters on the side. Sometimes it enters near the bottom through the blow-off pipe.

There should always be a hand valve in the feed pipe near the boiler and a check valve outside of this. The hand valve is placed close to the boiler so that in shutting down in cold weather the water can be shut off. Also if anything happens to the check valve, the hand valve can be closed while the former is being repaired. Where bad water is being used the feed pipe is likely to become choked with scale, and if the pump or injector fails to work it is often well to look in this pipe for the trouble.

**488. Firing.**—Before firing up a boiler always see that there is plenty of water. Do not simply look at the glass, but clean the glass and see if it fills immediately. Try the try cocks and see if the water stands the same in them as in the glass. Notice the tubes and grates and see if they are clean.

**489. Firing with soft coal.**—Soft coal should not be thrown in in chunks; it should be broken into pieces about the size of a man's fist. Put the coal in quickly and scatter it over the fire as you throw it in. Keep the door open as short a time as possible, so that no more cold air will enter than can be helped. Keep the grates well covered with burning coal so that no cold air will come through them. If the boiler has more grate capacity than needed, do not keep fire on only a part of the grates, but check the fire by closing the drafts. When the fire cannot be kept down in this way without causing incomplete combustion, bricks may be placed over the



back end of the grate and to a height equal to the bridge wall.

Some furnaces and fuels require different depths of fire than others. The proper depth can be determined only by trial. Fine coal and a poor draft require a thinner fire than coarse coal and a strong draft. Engineers differ in regard to the best methods for keeping up a fire. Some suggest that it is best to keep the fresh coal near the door, and when it has become coked push it back to the rear, and again throw fresh coal in the front. By this method there is an intense fire maintained at the back of the furnace, and as the partially burned gases pass back they are completely burned. The advantage of this method lies in the fact that complete combustion is secured; consequently there is less smoke, but there is a corresponding disadvantage in keeping the fire door open so long and allowing the furnace to cool slightly.

**490. Cleaning.**—Do not clean oftener than necessary. Keep the clinker loosened from the grates between cleaning times. When cleaning large furnaces, rake all the fire to one side and then clean the grates. Rake a part of the live coals back on this side and put on fresh coal. When this is burning well clean the other side in the same manner. To clean small furnaces, crowd the fire back, clean the grates, then rake the fire forward again.

**491. Banking the fire.**—Fires are banked to keep the steam from rising when there is a good fire, and also to hold the fire over night. Banking a fire consists in covering the glowing coals with fresh coal or ashes. When banking a fire for the night, crowd the coals to the rear, then fill the front of the furnace with fresh coal, and open the damper over the fire enough to carry off the gases. All drafts should be kept closed. By banking a fire this way it will gradually burn back toward the door, thus

keeping the boiler warm, and in the morning there will be a good bed of coals which will start up readily. When a boiler is being used daily, it is considered more economical to bank a fire than to let it go out and then rekindle it in the morning.

**492. Drawing a fire.**—Fires are drawn when it is desired to cool the boiler down very quickly or when the water is dangerously low. A fire should never be drawn without first smothering it with ashes, dirt, or fresh coal. Drawing a fire without first doing this causes it to glow up, and for a moment become much hotter than before it was stirred. Never put water in a furnace, as it is liable to crack the grates. It will also produce so much steam that it will either blow back or else blow the fire out the door and make it too hot to work around.

**493. Priming.**—When water is carried over from the boiler with the steam the boiler is said to be priming. Priming can always be detected by the click in the engine cylinder, which shows that there is water there. Taking too much steam from the boiler at once, carrying too much water, or not having enough steam space will cause priming. If the cause is too much water, blow out some and then slowly start the engine. Carrying a high steam pressure and keeping the water as low as possible will retard priming to a certain extent.

**494. Foaming** is similar to priming, but it is generally caused by dirty or impure water. It can be detected by the rising and falling of the water in the gauge glass and by the engine losing power or speed; also by the clicking in the cylinder. When a boiler foams, the engine should be shut down at once and the water in the boiler allowed to settle. So much water is carried over in the steam that the glass does not show the true level. If after settling down it is found that there is plenty of water over

the flues, it will be safe to pump in more, but if the water is low, let the boiler cool down somewhat before filling.

A boiler is more likely to foam with a high-water level than with a low. It is also more likely to foam with low pressure than high. A sudden strain on an engine will sometimes cause the boiler to foam. If a boiler is likely to foam, it is advisable to carry low water and high pressure. Then if it still persists in foaming, shut down and pump in a quantity of water and allow some to run out. This will change the water. If this does not remedy it, the boiler must be cleaned.

**495. Low water.**—Should the water happen to get below the danger line in a boiler, immediately cover the fire with ashes, dirt, or even fresh coal, and as soon as it can be drawn without increasing the heat do so. But never draw the fire until it is in this condition. Do not start the feed pump, or start or stop the engine, or open the safety valve. Simply let it cool down. After it has become cool, then examine it for injuries.

If a failure of the injector or pump has caused the water to become low and there is still an inch over the flues or crown sheet, the engine should be shut down and attention given to the feed supply. When the water has become so low as this, do not try to repair the injector or pump with the engine still running, as it will run the water below the crown sheet before it is anticipated and thus make the boiler more dangerous.

**496. Corrosion and incrustation.**—It is practically impossible for an engineer to get for his boilers water which does not have some detrimental ingredients. Nearly all hard waters will form some sort of scale. While soft waters do not do this, they do contain acids which act on the boiler and fittings in a harmful manner.

The general impurities to contend with are the car-

bonates and sulphates of lime. These vary with the location and can be dealt with properly only after experiment. Generally, however, they are thrown down in the boiler in the form of a soft mud and can then be disposed of by blowing out and washing the boiler with a strong stream from a hose. The presence of other impurities, such as oils or organic matter, or even sulphates of lime, makes these lime scales hard and adhesive. Removing the water from the boiler while still hot will cause these scales to bake or dry on the parts, in which case it is very difficult to remove them. Wherever it is possible, run some soft water through the boiler for a few hours before cooling down to clean. The acids will act upon the limes and loosen them from the tubes, etc.

Since the lime impurities of water are thrown down at a temperature of about 200° F., there are devices on the market which allow the feed water to mingle with the exhaust steam. This heats the former to a temperature sufficient to throw out the lime parts.

**497. Boiler cleaning.**—It is essential that a boiler be kept clean both inside and out. Authorities have stated that one-tenth inch of scale will require 15 per cent more fuel. Boiler scale is a non-conductor of heat; consequently, the flues must be kept hotter to affect the water as much with scale as without.

The frequency of washing a boiler can only be determined by experience with the water used and the surrounding conditions. Usually a traction boiler should be cleaned once a week, but there are wide variations from this rule.

Often when there is considerable mud in the water it can be blown out by means of the lower blow-off valve. It is good practice to fill the boiler extra full at night; then in the morning when the sediment has settled and

there is about 20 pounds of steam, blow off through the lower valve until the proper water level has been reached. When the boiler is in operation the circulation keeps the dirt mixed and it does not avail much to blow off then.

A good way to wash a boiler is to allow it to cool down until one can bear his hand in it; then open the blow-off valve and let the water run out. Remove the manhole and handhole plates and scrape all tubes and the shell with a scraper made for the purpose, then wash well with a hose and force pump.

**498. Cleaning the flues.**—Fire tubes should be cleaned at least once a day, and sometimes oftener. This is done by means of a scraper or a steam jet. Scraping should always be done in the morning before firing up. Never do it just after the fire is started, for then the tubes are wet and pasty. If they have to be cleaned while running, do it as quickly as possible and let as little cold air as possible get into them.

**499. Boiler compounds.**—Often there are cases where the impurities in boiler waters are such that they form a hard scale. In these cases it is nearly always advisable to use a boiler compound. If the proper compounds are used, they will dissolve the scale and throw it down in the form of a mud. Then it can be blown out. Wherever the scale does not become hard it is very seldom advisable to use a compound.

Wherever a compound is necessary it is best to have a chemist analyze the water and make a compound to suit the case, giving directions as to use and quantity to be used. For traction and small creamery service this is not practical. Soda ash gives very good results for creamery service. It has no offensive odors and is comparatively cheap. Sal soda has also been used with good results. For boilers where steam is used only for en-

gines, kerosene is largely used. Kerosene is also good to remove scale already formed. Where a sight-feed lubricator is available, kerosene may be fed through it, but when not the kerosene may be put into a boiler before filling. The kerosene floats, and as the water rises it adheres to the sides and tubes. Avoid using a compound except when absolutely necessary.

**500. Blister.**—A blister in a boiler is identical with a blister on the hand. On account of imperfect material or dirt, the metal will separate and one part will swell. Wherever there is a blister it is best to cut this part out and patch. If the blister is around the fire, a new half sheet should be put in.

**501. Bag in a boiler.**—A boiler is likely to bag if dirty, or if a quantity of oil has found its way into it. The oil will stick in one place and keep the water away. Then the fire will overheat this place and the inside pressure force it out. In forcing out the place it breaks the oil scales and allows the water to run in and cool it off. Sometimes it is best to put in a new half sheet where a bag is formed, but often it can be repaired by heating the place and driving it back.

**502. Cracks** sometimes form in the flue sheet because the flues are expanded too much. They are often formed in riveting. Whenever a crack is discovered it can be mended by drilling a hole in the end of the crack and putting in a rivet. This keeps the crack from getting larger; then the crack can be filled in.

**503. Laying up a boiler.**—In laying up a boiler, always clean it thoroughly. Scrape and wash it inside and out, and then paint the outside with black asphaltum or graphite and oil.

## CHAPTER XIX

### STEAM ENGINES

**504. Early forms.**—Hero of Alexandria is given credit for being the first man to use steam as an agent to convert heat energy into mechanical energy. He produced an æopile which operated with steam upon the same principle that our present-day centrifugal lawn sprinklers work with water.

History gives us ideas which were advanced by certain men, but nothing of importance after Hero's machine until 1675, when, jointly, Newcomen, Calley, and Savery invented what has been known as the Newcomen engine. Fig. 242 is a drawing of this engine as it was used for pumping water. *A* is the pump plunger and is always held down by the weights *B*. The steam, after being generated in the boiler *C*, is passed through valve *D* to the cylinder *F*. The piston *H*, which is up as the steam enters, is connected with the pump by means of the walking beam *I*. When the cylinder *F* is filled with steam, the valve *D* is closed and the valve *E* opened, letting in a jet of water from the previously filled tank *G*. As the water enters the cylinder it condenses the steam *F*, thus producing a vacuum in the cylinder, consequently the atmosphere will act upon the piston *H* and force it down. As it forces the steam piston down it raises the piston *A*, and with it the water.

After Newcomen, Watt produced probably the most important improvement of the steam engine. It was in 1769 that he got out an engine which would not condense the steam in the working cylinder, and by so doing cool off the walls, but he condensed it in separate vessels, which produced a continuous vacuum. The same principle as that of Watt is in use in the condensing steam engine of to-day, the only changes being in the mechanism for admitting and releasing the steam, in mechanical make-up and methods whereby labor in the machine shop is reduced.

**505. The present engine.**—The working parts of the present engine are all of the same general plan, with dif-

ferent designs for carrying out the actions. The principle is that of a cylinder separated into two parts by a piston. There is a valve connected with the cylinder by

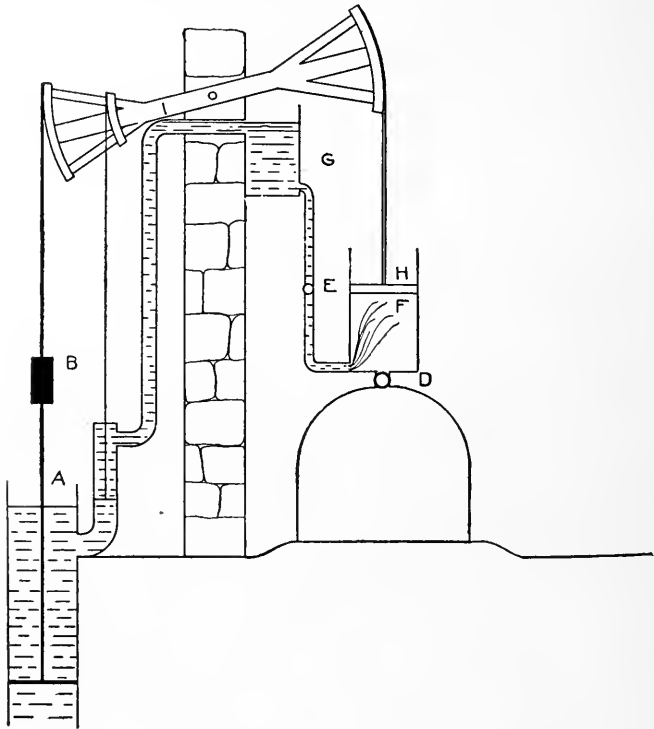

FIG. 242—NEWCOMEN'S ENGINE

means of which the steam is thrown from one side to the other. This valve also conducts the exhaust steam out of the cylinder. In Fig. 243, *A* is a steam chamber which receives the steam from the boiler. *B* is the valve which slides back and forth on the valve seat *J*. The valve *B*, situated as it is in this figure, allows the steam to pass



from the steam chest *A*, through the steam port *C*, into the front end of the cylinder *D*, and press against the piston *E*. This forces the piston through the cylinder toward the end *F*. At the same time the steam which

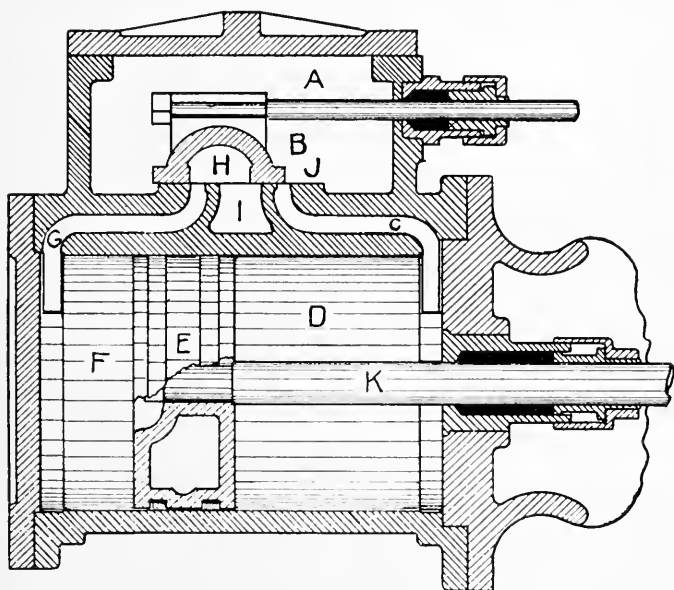

FIG. 243—CYLINDER AND VALVE OF STEAM ENGINE

has been previously admitted to the end of the cylinder *F* is forced out through the cylinder port *G* into the exhaust chamber *H*, and out through the exhaust port *I* into the air. By the time the piston *E* has reached the end of the stroke the valve *B* has reversed its position so that the steam chest *A* is connected with the end of the cylinder *F* by way of the steam port *G*. The exhaust port *I* is now connected with the exhaust end of the cylinder *C*, hence as the steam enters the cylinder at the end *F* it drives the piston toward the end *D*.

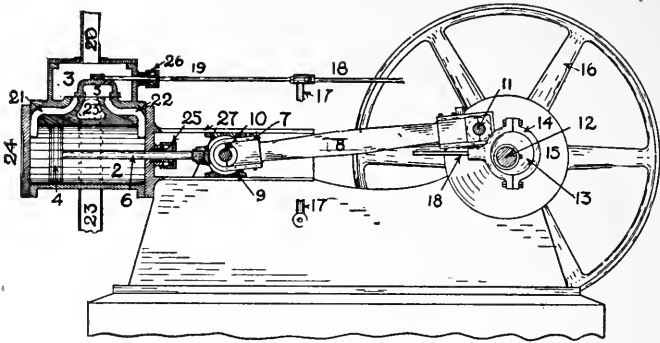

FIG. 244

- |                    |                      |                       |
|--------------------|----------------------|-----------------------|
| 1. Base.           | 10. Wrist pin.       | 18. Eccentric rod.    |
| 2. Cylinder.       | 11. Crank pin.       | 19. Valve rod.        |
| 3. Steam chest.    | 12. Crank shaft.     | 20. Steam inlet pipe. |
| 4. Piston.         | 13. Eccentric.       | 21-22. Steam ports.   |
| 5. Valve.          | 14. Eccentric strap. | 23. Exhaust pipe.     |
| 6. Piston rod.     | 15. Crank disk.      | 24. Cylinder head.    |
| 7. Crosshead.      | 16. Flywheel.        | 25-26. Packing boxes. |
| 8. Connecting rod. | 17. Valve rod guide. | 27. Guides.           |
| 9. Crosshead shoe. |                      |                       |

506. Classification of steam engines.—

- |                      |   |
|----------------------|---|
| Speed                | { High<br>Low                                 |
| Disposition of Steam | { Condensing<br>Non-Condensing                |
| Number of Expansions | { Simple { Single<br>Double                   |
|                      | { Compound { Tandem<br>Cross<br>Twin          |
| Speed Regulation     | { Throttling Governor<br>Automatic<br>Corliss |
| Kind of Work         | { Stationary<br>Marine                        |
|                      | { Locomotive { Rail<br>Traction               |
| Pressure on Piston   | { Single Acting<br>Double Acting              |

The classes of engines generally used in agricultural pursuits would be known as high-speed, non-condensing, either simple, single or double, or compound tandem or cross, throttling governed, either stationary or locomotive traction and double-acting.

**507. Generation of steam.**—Enclose 1 pound of water at a temperature of  $32^{\circ}$  F. in a cylinder under a movable frictionless piston. Suppose the piston to have an area of 1 square foot, but no weight other than the atmospheric pressure. Apply heat to the water and the following results will be noted:

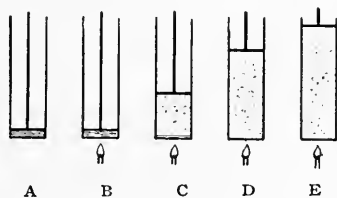

FIG. 245

*A*, one pound of water at  $62^{\circ}$  F.; *B*, one pound of water at  $212^{\circ}$  F., but lacks heat enough to turn it into steam; *C*, is saturated steam in contact with the water; *D*, one pound of steam at  $212^{\circ}$  F.; *E*, one pound of superheated steam.

1. The temperature rises, but the piston remains in the same position until a certain temperature is reached. When the piston commences to rise the degree of temperature is known as the boiling point. This point varies with the pressure. If the pressure bearing on the piston had been 10 pounds to the square inch instead of 14.7, the boiling point would have been reached at a lower temperature, and if the pressure had been 20 pounds to the square inch, the boiling point would have had a higher temperature.

2. As soon as the water has reached the boiling point, though heat still be applied, there is no further rise in

temperature, but steam forms and the piston gradually rises. Since the water is passing into steam, it must be disappearing. During formation the steam and the water remain at the same temperature as the water was when steam commenced to form. The heat which has been continually added has been used to convert the water into steam and is known as **latent heat**.

3. After all the water has been evaporated, if heat be still applied the temperature of the steam will commence to rise and the piston will also continue to rise. Since the steam is not now in contact with the water and is hotter than the steam was when formed and in contact with the water, we have **superheated steam**; in other words, steam which is heated above the temperature of the boiling point of water, which corresponds to the pressure at which it is generated.

**508. Saturated steam** is steam at its greatest possible density for its pressure. It is invisible and must contain no water in suspension; in other words, it must be dry and still not be superheated. The temperature of saturated steam in the presence of water is the same as that of the water, and for steam of a given temperature there is only one pressure. If the temperature increases and the volume remains constant, the pressure does likewise, for as the temperature increases more water is evaporated, or if the temperature decreases the pressure does also and some of the water is condensed.

**509. Total heat of steam** is made up of two components, heat of the liquid and latent heat.

*Heat of the liquid* is the amount of heat there is in water at the temperature of the steam.

*Latent heat* is the amount of heat required to evaporate 1 pound of water at a given temperature into steam at the same temperature. It is made up of two components.

One is the heat required to overcome the molecular resistance of water to changing from the liquid state to the gaseous. This is known as internal latent heat. The other component is the heat required to overcome the external resistance or pressure.

**510. Volume and weight of steam.**—The weight of a cubic foot of steam at  $212^{\circ}$  F. is 0.03758. If the temperature be increased to  $337^{\circ}$ , which corresponds to a gauge pressure of 100 pounds, the weight of a cubic foot will be 0.2589 pounds. By increasing the weight of steam we decrease the volume; i.e., the volume of 1 pound of steam at  $212^{\circ}$  is 26.64 cubic feet, but at  $337^{\circ}$  it is only 3.86 cubic feet. Hence when it is stated that steam has a volume of so many times the volume of an equal weight of water the temperature or pressure of the steam must be known. Often in testing a steam boiler it is assumed that as many pounds of steam are evaporated as there have been pounds of water fed to the boiler. This is an erroneous assumption, for there is always a certain per cent of the steam which is not steam but water in suspension. This, of course, will make the boiler appear to be generating more steam than it really is, but when this wet steam comes to the engine it will be charged against the engine as using all steam and consequently much more than is necessary, when in fact it is not using so much steam as is recorded, but is passing water through the cylinder.

**511. Expansion of steam.**—When saturated steam is used in an engine without expansion only about 8 per cent of the heat expended is converted into useful work. By not admitting steam into the cylinder for the full length of stroke, as shown in a previous part of this chapter, but by cutting it off during the first part of the stroke and allowing it to expand during the remaining

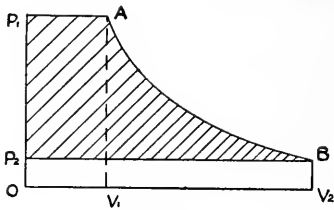

FIG. 246

part of the stroke, more work can be obtained from the same amount of steam.

In Fig. 246 let the distance  $OV_2$  represent the length of stroke,  $OP_1$  the pressure of steam as it enters the cylinder and while in communication with the boiler. If the piston starts at the point  $O$  and travels to  $V_1$  with the valve wide open, steam will continue in the cylinder at the pressure of the boiler, i.e., the pressure at  $A$  will be the same as at  $P_1$  and the line  $P_1A$  will be parallel to the line  $OV_1$ . Now, if steam is cut off at  $V_1$  and no more allowed to enter, the pressure will fall as fast as the steam expands and the line  $AB$  is formed. During this part of the stroke all the work which is done in the cylinder is due to the expansion of the steam which was admitted during the first part of the stroke. When the piston reaches  $V_2$  the steam is exhausted against a back pressure of  $OP_2$ .

The work done during the admission of steam is represented by the area  $OP_1AV_1$ , and is all the work this amount of steam would do if it had not been allowed to expand.

The work done during expansion is represented by the area  $V_1ABV_2$ .

The total work done by the steam is the sum of these two areas, or  $OP_1ABV_2$ .

Then, of the total work done by the steam that represented by the area  $V_1ABV_2$  is gained by using the steam expansively.

**512. Losses in a steam engine cylinder.**—Only 2 to 10 per cent of the total heat supplied to a non-condensing

steam engine goes into useful work. In multiple-expanding steam engines this percentage is often raised as high as 20. The rest of the energy is lost by radiation, condensation in the cylinder, and the amount carried away to exhaust. The temperature of the walls of the cylinder rises and falls as live steam enters and expands to the pressure of exhaust; in other words, the cylinder walls have practically the same temperature as the exhaust steam, so when the live steam enters it heats the walls to a temperature nearly equal its own. This then is the loss due to radiation. As the steam expands in the cylinder there is a great deal of it which condenses. Due to this condensation, the latent heat of the steam is thrown off, doing no work. Not only is all the heat left in that part of the steam which entered the cylinder to fill the piston displacement lost when release takes place, but about one-third of the steam which enters the clearance space is a total loss. Hence the smaller the clearance volume the more economical the engine.

**513. Slide valve.**—The slide valve is the most common method for regulating the admission of steam to and exhaust of the steam from a steam engine cylinder. Its functions are: (1) admission of the steam to the cylinder to give the piston an impulse; (2) to cut off the supply of steam at the proper point; (3) to open a passage for the escape or exhaust of the steam from the cylinder; (4) to close the exhaust port at the proper time to retain enough steam in the cylinder to give the piston a cushion.

**514. Lap of valve.**—When the valve is in mid position (Fig. 247) the amount it laps over the edges of the steam port is known as lap. The amount which the valve laps over the outside is outside lap, and that which it laps over the inside is inside lap.

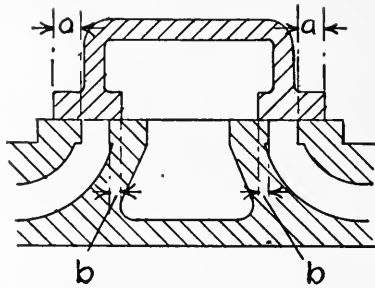

FIG. 247

*Object of lap.*—Lap is put on the slide valve to secure the benefit of working steam expansively. If a valve has no lap, steam will be admitted the full length of the stroke and allowed to escape to the exhaust at boiler pressure. By the application of lap, steam is cut off from the boiler when the piston has traversed from three-eighths to five-eighths of the stroke, and as the piston completes the stroke the steam does work by expanding.

**515. Lead** is given to a valve to admit steam to the cylinder just before the piston reaches the end of the stroke. By so doing a cushion is produced in the cylinder upon which the piston acts and this saves a jar. Lead not only produces this cushion effect, but also causes the port to be partly opened so that a full amount of steam can be admitted to the cylinder the instant the piston starts on its return stroke. Lead affects the ex-

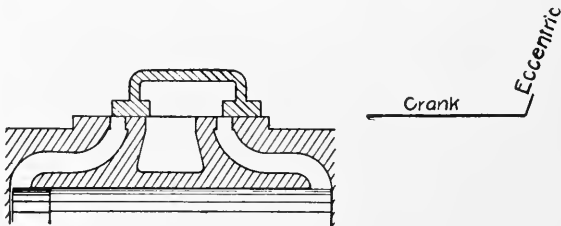

FIG. 248



haust port by having it open in time for the exhaust steam to be sufficiently released so that at the instant the piston starts on the return stroke there is no back pressure. Fig. 248 shows the lead, both inlet and ex-

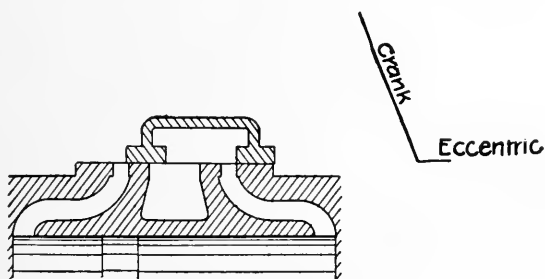

FIG. 249

haust. Fig. 249 shows the valve when at its end of the stroke, showing that the exhaust port is completely opened, but that the inlet is not necessarily so. Fig. 250 represents the position of the valve when the piston is at the opposite end of the stroke. It will be noticed that

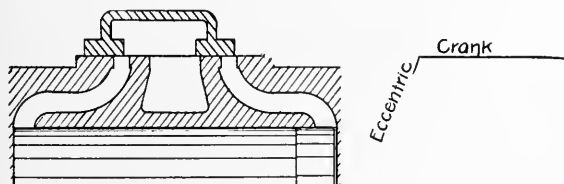

FIG. 250

the lead in this case is the same as that in Fig. 248. This should be true in all engines.

A lead of  $1/32$  inch is about proper for most engines. Too much lead in a valve allows steam to enter the cylinder so soon that the piston has to complete its stroke against boiler pressure, hence a loss of energy. Also

where there is too much lead the exhaust port is likely to open so soon that the steam is released before it expands as much as possible. Again, if it has not sufficient lead there will be no cushioning effect, and in addition sufficient steam will not have entered the cylinder by the time the piston starts on the return stroke to produce the maximum pressure.

**516. Eccentric.**—The eccentric is a mechanism often used where it is impossible to use a crank. The eccentric of a steam engine consists of a disk or sheave fastened to the crank shaft in such a manner that it is eccentric or out of center with the center of the shaft. Around this sheave is the eccentric strap, which is so adjusted that there is a free and smooth bearing surface between the two. The eccentric rod, which actuates the valve, is attached to a strap and gives to the valve a reciprocating motion similar to that of the piston, but on a reduced scale. The throw of the eccentric, which is also the travel of the valve, is twice the distance from the center of the eccentric to the center of the shaft. In other words, it is the same as that of a crank whose length of arm is equal to the eccentricity of the eccentric.

**517. Angle of advance.**—On a slide-valve engine, with the valves properly set when the engine is on dead center, the center line of the eccentric will not be at right angles to the crank, but will be at an angle greater than a right angle. The difference between this angle and a right angle is known as the angle of advance.

The size of this angle varies with different engines, but it is generally from  $10^{\circ}$  to  $20^{\circ}$ . The object of the angle of advance is to give the engine lead, and to vary the lead means to change the position of the eccentric on the shaft. Changing the position of the eccentric changes the angle of advance.

In Fig. 251 let  $AB$  be the travel of the valve,  $OA$  the position of the crank, and  $OC$  the position of the eccentric. Then the angle  $COD$ , or  $\theta$ , is the angle of advance. A perpendicular let fall from  $C$  to  $OB$  gives the distance  $OE$ , which designates the position of the valve. In this instance it also gives the lead, i.e.,  $OE$ , is the lead of the valve. If the position of the crank is changed from  $OA$

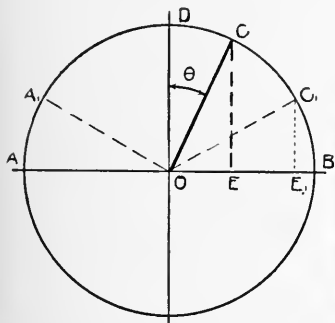

FIG. 251

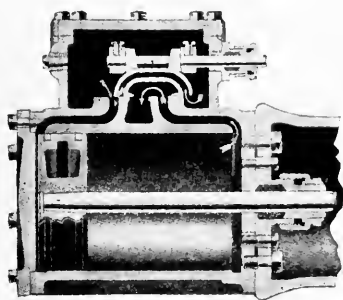

FIG. 252—DOUBLE-PORTED VALVE

to  $OA_1$  the valve will move the distance  $OE_1$  or a total distance of  $EE_1 + OE = OE_1$ .

**518. Double-ported valves.**—The common slide valve has to travel so far in opening a steam port that there is considerable wire drawing of the steam as it enters the cylinder; also it does not permit a free release of the exhaust steam. Some manufacturers are putting in their engines a double-ported valve (Fig. 252) which gives about the same port opening as the simple slide valve and with only half the travel.

**519. Balanced valve.**—By inspecting Fig. 243 it will be noticed that there is high-pressure steam all over the outside of the valve and none on the inside. This excessive pressure on the outside causes a large amount of friction between the valve and the valve seat. To overcome this

excessive friction balanced valves are now made. Some have on the back a friction ring, which is held against the steam chest by coil springs or live steam in such a manner that the steam does not get behind the valve. Other valves are so constructed that the high pressure steam

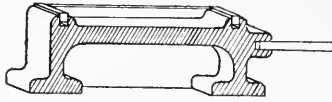

FIG. 253

is kept from the back of the valve by means of pieces of strap steel working in grooves in the back of the valve. These pieces of steel are generally

held out against the steam chest cover by means of coil springs. Fig. 253 illustrates this type of valve.

**520. Piston valve.**—The piston valve is probably the most effectually balanced valve. The principle of this valve is the same as that of the common slide valve, but instead of having a seat it is cylindrical in form and has packing rings the same as a piston, making it steam tight (Fig. 254).

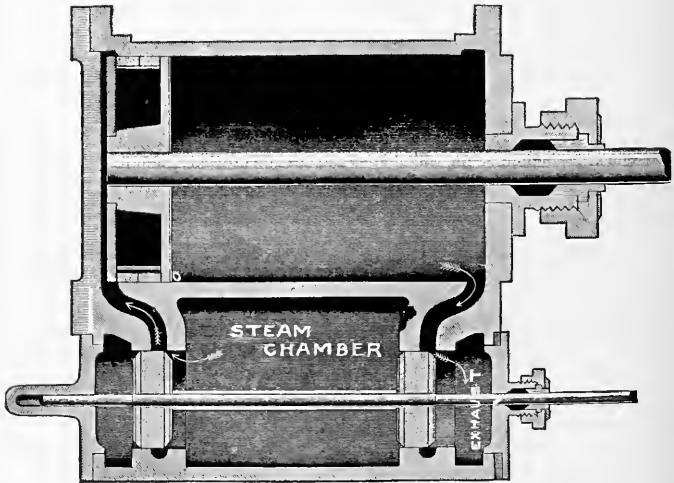

FIG. 254—PISTON VALVE

**521. Dead center.**—An engine is on dead center when a straight line passing through the centers of the cross-head and crank shaft will pass through the crank pin. If an engine is on dead center it will not start, although the ports may be open. Locomotives and often traction engines have two cylinders with their cranks at right angles, so that one or the other will always be off center, and consequently will start without turning the wheel by hand.

*Locating dead center.*—When the crank is passing dead center the piston moves so slowly that a movement of 2 or 3 inches of the crank is hardly perceptible on the piston. This, however, is not true of the valve, for when the crank is passing dead center the valve is moving its fastest, consequently it is essential that dead center be definitely determined. About the simplest and most accurate method for putting an engine on dead center is by means of a tram (Fig. 255). At some convenient place in the engine frame make a clear, sharp-cut center-punch mark, and with the flywheel about one-eighth

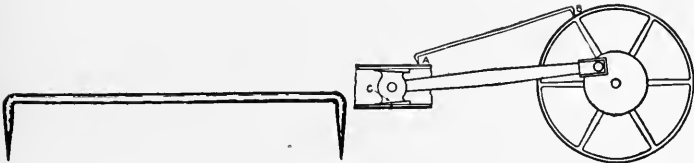

FIG. 255—TRAM

FIG. 256

revolution off center make another center-punch mark in the wheel. Set the tram in the center-punch marks as shown in Fig. 256. Now with a sharp knife make a mark *C* across the intersection of the crosshead and the guide. Turn the wheel down until the mark on the crosshead and the guide come together again, then make another mark in the wheel so that the tram will drop into it as

in Fig. 257. Having done this, find the point *E*, midway between the two marks on the flywheel, and make a punch mark there. Turn the wheel until the tram drops into this mark (Fig. 258), and the engine will be on dead center. To find the opposite dead center do likewise or

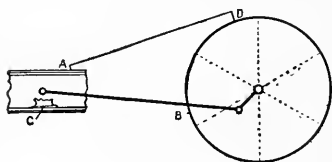

FIG. 257

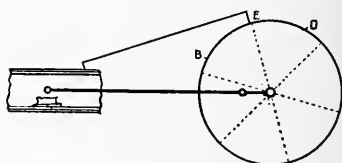

FIG. 258

measure half around the wheel. When it is inconvenient to measure on the flywheel, the crank disk can often be used.

**522. Setting the slide valve.**—To set the slide valve, remove the steam chest cover and put the engine on dead center. Turn the eccentric on the shaft until it is  $90^\circ$ , or a quarter of a revolution, ahead of the crank in the direction the engine is to run. Now adjust the valve on the rod until it is at its center of travel, then again move the eccentric ahead, this time only until sufficient lead is obtained. Fasten the eccentric to the shaft and tighten up the lock nuts on the valve; then turn the engine over to the other dead center and see if both sides have the same lead. If the lead is the same in both ends, the valve may be set. If there is more lead in one end than the other, move the valve on the rod an amount equal to one-half the difference. If now the valve has too much or too little lead, the eccentric should be slipped forward or backward, as the case may require.

Moving the eccentric in the shaft increases or diminishes the lead, depending upon the direction it is moved.

Moving the valve on the rod increases or diminishes the difference in lead.

If an engine has a rocker arm pivoted in the center, move the eccentric in the opposite direction. Otherwise proceed in the same manner as without the rocker arm.

**523. Reversing a simple slide valve engine.**—To set the valve of a simple engine so that the engine will run backward, or, as is often termed, **under**, remove the steam chest cover, set the engine on dead center, and ascertain the lead. Now loosen the eccentric from the shaft and turn it backward until the lead is again the same as before. The distance which the eccentric is to be turned backward should be  $180^\circ$  plus twice the angle of advance (Fig. 259).

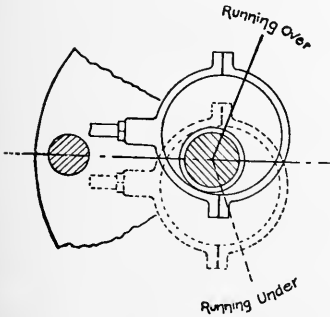

FIG. 259

The valve does not need to be moved on the rod, nor the rod lengthened or shortened. The only caution necessary is to be sure that the lead is always on the end the piston is on when the engine is on center.

An engine running backward or under will do just as much work as one running forward or over, but when it is running over the pressure of the crosshead is always down, while when it is running under the weight of the crosshead and connecting rod is down, but the pressure caused by the steam on the piston and the angle of the connecting rod and piston rods will be up; hence there are two forces working in opposition at the crosshead, and this will cause an up-and-down pound. Not only this, but if an engine runs over, this force will all be exerted upon the engine bed and not the frame.

**524. Reversing gears.**—Since the simple engine cannot be reversed without stopping and using time, engines which have to be reversed often and quickly are provided with reversing gears. That is, they are arranged so they can be reversed with a lever. There are two general classes of reversing gears, the double-eccentric and the single-eccentric.

**525. Hooking up an engine.**—Some engine makers designate their reversing gears as expansion gears. Such gears are simply reversing gears which can be used so that the steam works on expansion. Reversing gears are actuated by means of a lever which works in a quadrant. When the lever is in one half of the quadrant steam is admitted so that the engine runs under, and when in the other half the engine runs over. These gears are generally so constructed that if the engineer wishes his fly-wheel to run in a direction away from him he moves the lever in the direction the wheel turns, and if he wishes the wheel to run toward him, he moves his lever in that direction. Some engines are connected up in the opposite manner. When an engine is carrying an overload, the lever is thrown into the last notch in the quadrant and the piston receives steam nearly the full length of the stroke. Although this has to be resorted to in some instances, it is not an economical way to run an engine, as the steam has no chance to expand. When an engine is running on full load, that is, when it is doing only its rated capacity of work, the lever should not be in the end notch of the quadrant, but should be somewhere between the end notch and the middle. By having an engine hooked up, steam is cut off in an earlier part of the stroke and consequently works on expansion the remaining part.

**526. Double-eccentric reverse or link-motion reverse.**—



There are several types of this reverse, but probably the Stephenson link is the most popular. It will be described here. In Fig. 260, *A* is the quadrant over which the reverse lever *B* works. The reverse lever *B*, acting through the rocker arm *C*, raises and lowers the link *H*. *F* and *G*

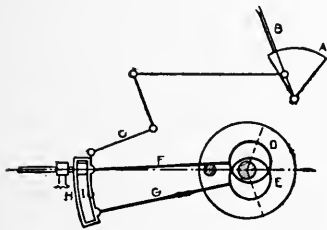

FIG. 260—PRINCIPLE OF STEPHENSON LINK MOTION

are eccentric rods connected at one end with the eccentrics *D* and *E*, respectively, and at the other end with the ends of the link *H*. *I* is a block which is attached to this end of the valve rod and is worked over by the link *H*. With the reverse lever in the position in which it

now is, the eccentric *D*, through the rod *F* and block *I*, actuates the valve. By throwing the reverse lever to the other end of the quadrant, the link is raised so the eccentric *E*, through the rod *G* and the block *I*, actuates the valve. It will be noticed that the angles of advance of these two eccentrics are practically the same as they were for the two positions of the eccentric in Fig. 259, where the simple engine was reversed. Thus it is seen that the engine has been reversed by simply shifting the motion of the valve from an eccentric which runs the engine under by means of the link *H* and the block *I*, to an eccentric which runs it over. If the reverse lever is hooked up in the middle notch of the quadrant, the block *I* will be acted upon by both eccentrics, one acting in one direction and the other oppositely; consequently there is only a very slight movement of the valve.

*Setting the double-eccentric valve.*—Put the engine on dead center and drop the link down as far as possible and still have clearance between the link and the block; then

set the valve in the same manner as a simple slide valve. To set the other eccentric, raise the link and proceed in the same manner, but remember the engine is to run in the opposite direction.

527. **Single-eccentric reverse gear.**—Like the double-eccentric reverse, there are several types of the single-eccentric reverse, but the Woolf reverse gear, being the

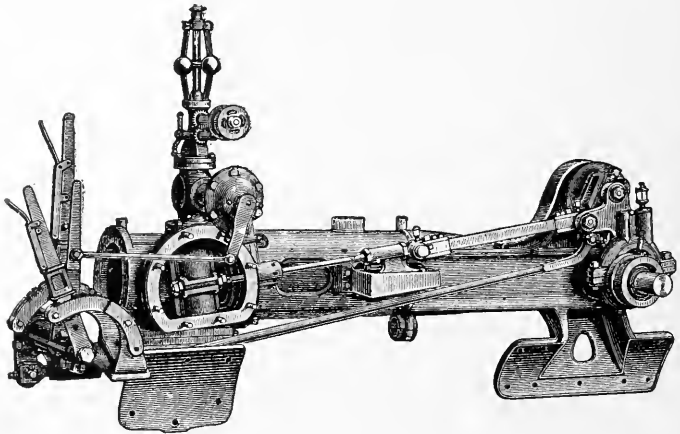

FIG. 261—WOOLF REVERSE GEAR

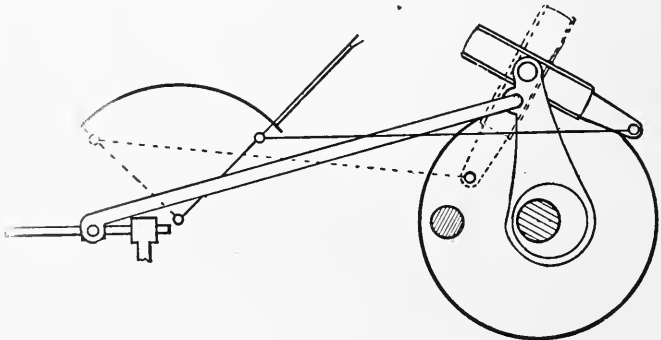

FIG. 262—PRINCIPLE OF WOOLF REVERSE GEAR

most common, will be discussed here. This reverse gear (Fig. 261) has few parts to wear and get out of order and may be set so that steam can be used on expansion.

It will be noticed that in this reverse gear (Fig. 262) the throw of the eccentric is set opposite to the crank instead of about at right angles to it, as shown with other gears. By moving the lever from one end of the quadrant to the other the guide *A*, which carries the roller *B*, changes position as shown by dotted lines. This causes the valve to move in the opposite direction. All types of reversing gears have some mechanical means of operating the throw of the valve. This is equivalent to changing the position of the eccentric in the shaft, and if one method of setting the valve is mastered all others will be easily picked up.

**528. Angularity of connecting rod.**—Due to the angularity of the connecting rod, the piston of an engine travels faster and farther while the crank is passing through the half of its rotation nearer the cylinder than

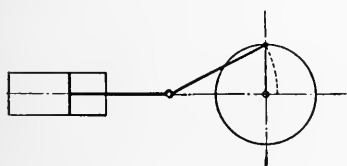

FIG. 263

it does while the crank travels the opposite half of its rotation. By reference to Fig. 263 it will be noticed that the crank has traveled only half its distance and the piston has

passed over more than half its stroke. As the crank passes through the other half of its revolution, which it does in the same time as it did the first half, the piston travels as much less than half its stroke as it traveled more than half during the first revolution of the crank, consequently does not travel nearly as fast during this half of the time as it does during the other half. Because of this unequal travel of the piston one end of

the cylinder is doing more work than the other, and as a result there is excessive vibration and unequal strain in the parts. It is impossible to change the connecting rod, but there are now valve gears on the market which partly rectify the defect by the manner in which they admit the steam. Owing to mechanical complications which arise, it is still a question as to the advisability of putting these valves on small engines.

**529. The indicator diagram.**—Fig. 264 is an ideal indicator diagram and can be described as follows: The line  $xy$  is traced on the paper with no pressure in the cylinder, i.e., it is the atmospheric line.

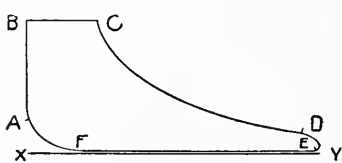

FIG. 264

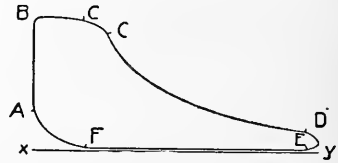

FIG. 265

The point  $A$  shows when steam commences to enter the cylinder. Point  $B$  is the maximum pressure and the time when the steam port is opened its full amount. From  $B$  to  $C$  the port is open, and the pressure is the same as  $B$ . At  $C$  the cut-off takes place and the steam works on expansion. At  $D$  the exhaust port opens, and from  $D$  to  $E$  the pressure drops to the pressure at which the steam exhausts to the air. From  $E$  to  $F$  is back pressure, due to exhaust. At  $F$  compression takes place and lasts until  $A$  is reached.

The different parts of the diagram are known as follows:

- $xy$ . Atmospheric line,
- $AB$ . Admission line,
- $BC$ . Steam line,
- $CD$ . Expansion line,
- $DE$ . Exhaust line,
- $EF$ . Back pressure line,
- $FA$ . Compression line,
- $A$ . Point of admission,
- $C$ . Point of cut-off,
- $D$ . Point of release,
- $F$ . Point of compression.

There are mechanical difficulties which must be taken into consideration; hence the diagram as usually obtained from a steam engine cylinder is not like Fig. 264, but is like Fig. 265. Here the corners are rounded off, due to wire drawing and slow-acting valves. The line *BC* drops, due to the resistance of steam moving through the boilers. The point *C* is not a sharp one, since the valve cannot move quickly enough to cut off steam instantaneously, but commences to cut off at *C'*, and complete cut-off takes place at *C*. This fall in pressure after the valve commences to cut off and before it completely cuts off is known as wire drawing. Often the exhaust valve does not open soon enough for the pressure to fall to the back pressure line before the piston starts in the return stroke; hence the line *DE* of Fig. 264 is more like the line *DE* of Fig. 265.

**530. Attaching indicator to engine.**—Where indicator diagrams are to be taken from engines of 100 H.P. or more it is better to have two indicators, one for each end of the cylinder; but for engines of a capacity such as are used on the farm or in creameries one indicator connected to both ends of the cylinder by means of a three-way cock is fully as accurate as two. If there are no holes for attaching the indicator when the engine comes from the factory, drill into each clearance space *AA* (Fig. 266) of the cylin-

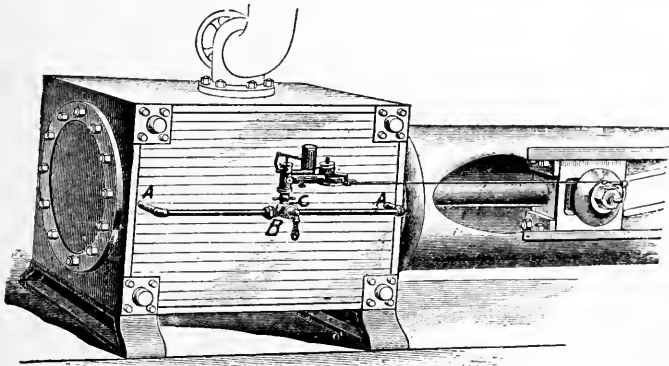

FIG. 266—ATTACHING AN INDICATOR TO AN ENGINE

der a hole of sufficient size to thread for  $\frac{3}{8}$ -inch or  $\frac{1}{2}$ -inch pipe, and by means of pipe fittings connect up to the three-way cock *B*. The connection on the indicator will screw into the cock at *C*. Since

the throw of the indicator drum is only about  $3\frac{1}{2}$  inches and the stroke of the piston is 8 to 20 inches, the length of stroke of the piston has to be reduced to that of the indicator. There are several mechanisms for this purpose, some of which come with the indicator (Fig. 267). If a reducing motion has to be devised, probably that shown in Fig. 268 is the most simple.

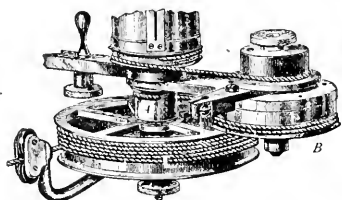

FIG. 267—REDUCING MOTION ATTACHED TO INDICATOR

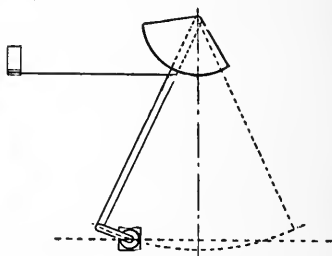

FIG. 268

**531. Taking indicator diagrams.**—To take an indicator diagram the string after being hooked up should be of proper length to give the indicator drum a clear movement. When the indicator is rotating back and forth, if the pencil is held against it the atmospheric line may be drawn. The cock should then be opened and the steam allowed to enter from one end of the cylinder until the indicator has become warmed up. Then the pencil should be held against the drum while the piston takes two or three strokes. A diagram can be taken from the other end of the cylinder on this same card by simply turning the cock over, or this card may be taken out and a new one put in.

**532. Reading an indicator diagram.**—To read an indicator for perfect valve setting it is best to compare it with a perfect diagram. It is assumed that in the diagram Fig. 269 the heavy line is the perfect one and those with dotted lines are taken from engines with poorly set valves.

*a* shows too early compression.

*a'* shows too late compression.

*b* shows excess of lead.

*b'* shows insufficient lead.

*c* shows wire drawing.

*s'* shows late release.

*s* shows early release.

**To read an indicator diagram for pressures.**—Whenever possible the scales should be divided into parts equivalent to the scale of the spring, i. e., if the spring is 60 pounds to the inch the scales should be divided into 60 parts. Whenever this is not possible a tenths or hundredths scale may be used. The scale shown in Fig.



FIG. 269

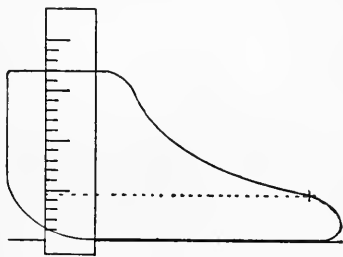

FIG. 270

270 is a tenths scale, and it now reads 1.7 inches with a 60-pound spring. This gives a steam pressure at that point of

$$1.7 \times 60 = 102.0 \text{ pounds.}$$

If the scale is moved down to the point of release it reads

$$0.45 \times 60 = 27.00 \text{ pounds.}$$

**533. Governors.**—The object of a governor is to maintain as nearly as possible a uniform speed of rotation of the engine. When the speed of the engine varies through several revolutions because of variation of load or boiler pressure, the governor will aid in regulating it, but if the variation of speed is confined to a single revolution or a part of a revolution, the variation must be cared for in the flywheel. Since governors for steam engines are attached to the engine, they cannot regulate the speed exactly, for they cannot act until the engine does. In other words, the engine has to commence to slow down before the governor will be affected. It then takes the governor a little time to act, and consequently the engine has quite a chance to vary its speed of rotation. In practice, however, when a slight change of speed takes place, a good governor acts instantly and allows only a

very small variation of speed. Governors regulate the speed of an engine in two ways: by varying the steam pressure as it enters the cylinder, and by varying the point of cut-off.

**534. Throttling governors.**—Governors which act upon the steam in such a manner as to vary the pressure in the cylinder are known as throttling governors (Fig. 271). In other words, they throttle the steam before it enters the steam chest so there is not enough admitted to fill the space intended for it. Therefore, boiler pressure is not attained, and consequently the steam does not exert as much force upon the piston as when the governor is not acting. As a result, the engine does not do its full capacity of work.

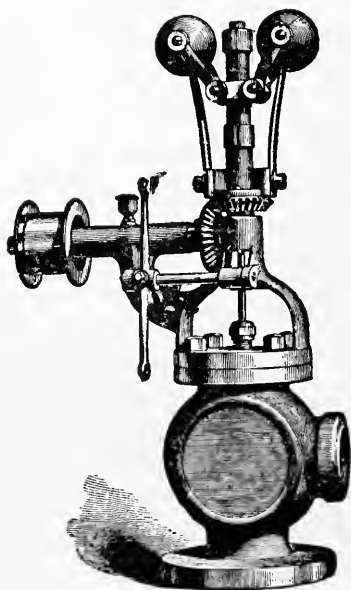

FIG. 271—THROTTLING GOVERNOR

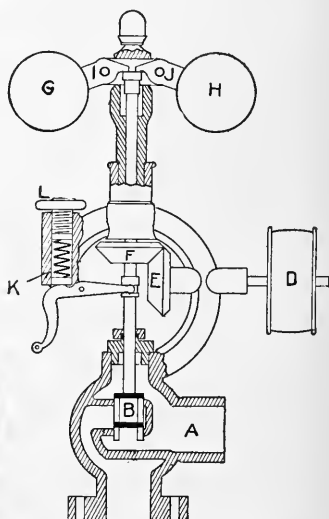

FIG. 272 —SECTIONAL VIEW OF THROTTLING GOVERNOR



*Principle of the throttling governor.* — Fig. 272 is a sectional view of a throttling governor. The governor is generally placed upon the steam chest, and when not in this place it must be as close to it as possible.

Steam enters the governor from the boiler through the pipe *A*. Passing through the governor valve *B*, it enters the steam chest *C*. If the valve *B* is clear up, which is analogous to wide open, the steam passes into the steam chest unmolested as far as pressure is concerned, but if the valve *B* is partly closed the steam is throttled as it passes the valve. Consequently the pressure in the steam chest is not as great as in the steam pipe *A*. From this it is seen that the only requisite for a governor, other than the design of valve *B*, is some device which will raise and lower the valve *B* as the speed of the engine increases or decreases.

The pulley *D* is run by a belt from the engine shaft, and whenever the speed of the engine varies the speed of this pulley also varies. By means of the beveled pinions *E* and *F* the motion is transmitted from the pulley *D* to the governor balls *G* and *H*. With no motion in the pulley *D* these balls hang down, but as soon as the pulley commences to revolve the balls do likewise, and, due to centrifugal force, they commence to rise. When the engine attains its full speed the balls, acting through the arms *I* and *J* and valve rod, should have partly closed the valve. By having the valve partly closed when the engine is running at its normal speed there is opportunity for the valve to be opened when the speed drops. If the engine is not carrying full load it will be inclined to run too fast. This increased speed of the engine causes the governor balls to rise higher and consequently close the valve a trifle. It will be noticed that the governor balls are not only acting on the valve *D*, but are

also acting on the spring. Hence if the spring  $K$  is tightened by screwing down on the hand wheel  $L$  the engine will have to be running faster before the governor will act. If the hand wheel is loosened, the balls will act more quickly, and consequently the engine cannot attain so high a speed.

If the belt of this governor be taken off, the engine will have to be controlled by the throttle, since there is nothing else to prevent the steam from flowing into the cylinder as fast as the cylinder will take it. If there is no one at hand to control the throttle, the engine will run away. This is the reason why so many engines run away when the governor belt breaks. A great many governors are now equipped with an idle pulley running on the governor belt. This pulley is attached to the throttle in such a manner that when the belt breaks the pulley is free to fall, and by so doing closes the throttle and stops the engine.

**535. Racing.**—An engine is said to be racing when its speed of rotation fluctuates badly with a constant load. Racing in nearly all cases is caused by the governor. Either it is not working satisfactorily, or else it is poorly designed. If the valve stem is packed very tight, the engine will have to attain a very high speed before the balls have sufficient force in them to force the valve down. Then when it is down the engine has to slow down entirely too much before the spring will have the energy to force the valve up. An engine will also race if the governor belt is loose and slips, or if the governor is improperly oiled.

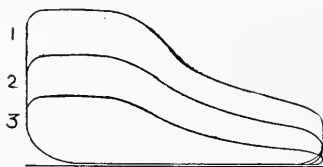

FIG. 273

**536. Indicator diagrams from a throttling-governed**

**engine.**—The indicator diagram shows more clearly the effect of throttling the steam of an engine than any description. Fig. 273 shows a diagram taken from an engine; No. 1, with full load; No. 2, with about half load; No. 3, with about quarter load.

In all the diagrams it will be noticed that the points of compression, admission, cut-off, and release remain constant, while the steam and expansion lines vary.

**537. Automatic cut-off governor.**—Steam cannot be used as economically under low pressure as under high,

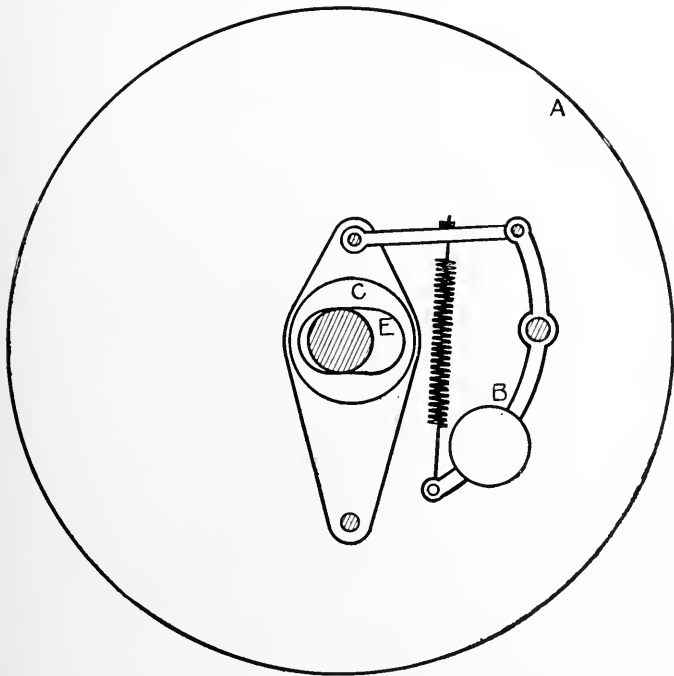

FIG. 274

hence when the steam is throttled down as in No. 3 (Fig. 273) it is not as economical as when used at full pressure. To overcome this loss in throttling-governed engines, automatic cut-off governors have been devised. These governors act in such a manner that they do not throttle the steam as it enters the engine, but change the point of cut-off and by so doing permit steam to enter for a shorter or longer part of the stroke (as the speed of the engine requires) at boiler pressure and allow it to work on expansion. Fig. 274 represents the outline of an automatic cut-off governor. *A* is the flywheel which carries the governor mechanism; *B*, the governing mechanism; *C*, the eccentric sheave; *E*, a slot in the eccentric sheave within which the engine shaft revolves. As the speed of rotation of the engine varies, the weight *B* will move the sheave *C* backward or forward across the engine shaft.

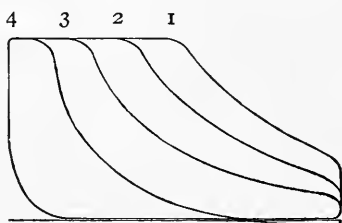

FIG. 275

This change in the position of the eccentric sheave changes the throw of the eccentric and consequently the point of cut-off of the valve. Fig. 275 shows indicator diagrams with varying loads. No. 1 is overload; No. 2, full load; No. 3, about half load, and No. 4, practically no load. The steam line for all loads is the same, but the point of cut-off varies, thus giving an increased or reduced amount of energy exerted on the piston. Diagram No. 4 shows how the steam has expanded below atmospheric pressure, and when the exhaust port is opened the pressure rises instead of falling. The area below the atmospheric line is then negative work. Instead of working a large engine on as light a

load as this, much of the time it is more economical to use a smaller engine.

**538. Corliss-governed engines** have a great many economical advantages over other types of engines: (1) reduced clearance volume, due to the proximity of the valves to the cylinder; (2) separate valves for steam and exhaust, the steam valves being on top and the exhaust beneath, so there is a free and short passage for the water to leave the cylinder; (3) a wide opening of the steam valve and a very quick closing at cut-off, thus giving a sharp point of cut-off without wire drawing; (4) the valve mechanism permits of independent adjustment of admission and cut-off release and compression. The disadvantages of this engine are that it is of necessity slow speed, and hence to get the required power must be large. This makes the first cost great, not only in the engine itself, but in the material for an engine room.

**539. A double-cylinder engine** (Fig. 276), or a double engine, as it is sometimes called, is an engine which has two cylinders, both of which take the steam directly from the boiler. Both cylinders of a double engine should be connected to the same crank shaft, and their cranks should be at an angle of  $90^\circ$  with each other. The only

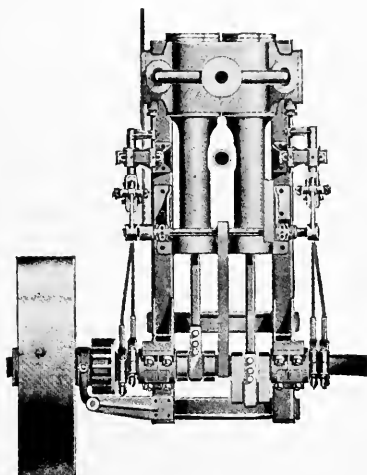

FIG. 276—DOUBLE-CYLINDER ENGINE

advantages to be gained from a double-cylinder engine are: (1) being able to start without turning off dead center by hand; (2) being able to start with a heavy load; and (3) being able to move slowly with a heavy load. If the cranks were set in line with each other, these advantages would not be gained. The disadvantages of a double engine are: more moving parts, greater chances for steam to leak about the cylinder and the piston, and more cooling surface, hence greater condensation during the working stroke. Although a double engine is more easily handled than a single one, there are only a few instances, such as plowing and heavy traction work, where its use is recommended for farm work.

**540. Compound engines.**—The purpose of compound engines is not to give a greater expansion. This could be accomplished with the low-pressure cylinder and early cut-off. The real purpose is (1) to keep the cylinders as nearly as possible at the temperature of the entering steam, preventing losses by condensation; (2) to reduce the surface exposed to the high-pressure steam to a minimum; (3) to use the high-pressure steam in a small cylinder, hence requiring less material to make it sufficiently strong.

The first cylinder, known as the high-pressure cylinder, expands the steam partly; then the second, or low-pressure, receives it and expands it further. Since the steam as it enters the high-pressure cylinder is under a higher pressure than when it enters the low-pressure cylinder, the latter cylinder must be larger than the former to accommodate the increased volume of the steam. Where steam is expanded in two cylinders the engine is known as a double-expansion compound; where it is expanded in three cylinders it is known as triple-expansion, and in four cylinders it is known as quadruple-



expansion. When one cylinder is in front of the other, the engine is said to be a tandem compound, and when the cylinders are side by side it is said to be a cross-compound engine. Fig. 277 shows the Woolf tandem-compound engine in common use in traction service.

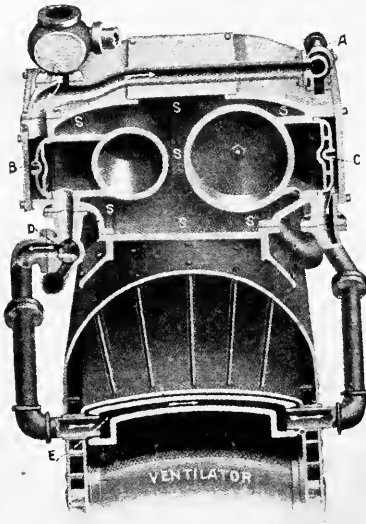

FIG. 278—CROSS-COMPOUND ENGINE

The arrows show the direction of the steam as it passes from cylinder to cylinder. Fig. 278 illustrates a cross-compound engine, showing how the steam passes through a superheater as it travels from the high-pressure to the low-pressure cylinder. It also shows the relative sizes of the two cylinders.

**541. Horse power of steam engines.**—There are three methods of rating steam engines. One method is by the indicated horse power, which is the total work

exerted by the steam in the cylinder; the second method is the actual or brake horse power (see Chapter I), which is the actual work delivered from the fly-wheel of the engine; and the third is the commercial rating.

**542. Commercial rating of steam engines.**—The commercial rating of all stationary steam engines is about their actual horse power, but the commercial rating of traction steam engines is far below their actual horse



power. This is a custom which originated in the horse power and is to be regretted.

At the time separators were run with horse power they were smaller than they are now and with fewer accessories. At that time 12 horses, by being overworked, would run the separator, but now the separators are larger and are equipped with self-feeders, band cutters, wind stackers, weighers, etc. All of this causes the new separators to run several horse power harder than the old ones. Although the present separators require much more power than the former ones did, competition has kept the rating of the engines down to that of the horse power, while factories are building them much larger. Most traction engines will develop at the brake three times as much power as their rated capacity.

A better way to judge the capacity than by its commercial rating is by the diameter of the cylinder, the length of stroke, and the number of revolutions of the flywheel a minute.

### HANDLING AN ENGINE

**543. Starting the engine.**—In starting an engine the operator should always see that the cylinder cocks are opened. While the engine has been stopped the steam has condensed and caused considerable water to form in the cylinder, and if there is not some means of letting this out there is danger of injury to the working parts. Even if no water has collected in the cylinder while the engine has been standing, the cylinder walls will be cold and condense the steam as it first enters. It is also well to open the pet cocks from the steam chest and allow the water in there to drain out, and not be carried through the cylinder. The throttle should be only partly opened at first in order to allow the cylinder to become warmed

up before full steam is turned on. If full steam is turned on at once there is danger of more water being condensed than the cylinder cocks will carry away. If the engine has a reverse gear, it may be worked back and forth and thus both ends of the cylinder allowed to warm up at once. As soon as the engine has reached its speed and dry steam comes from the cylinder cocks they can be closed and the throttle thrown wide open. The cylinder lubricator and other oil cups can now be started, and if necessary the boiler pump or injector.

**544. Running the engine.**—After the engine is once started all bearings should be watched to see that they do not heat. When they get so warm that the hand cannot be borne on them the engine should be stopped and the bearings loosened. If the engine runs properly, all repairs that can be made while the engine is in motion should be attended to: the oil supply looked after, oil cups kept full, etc.

**545. Stopping the engine.**—To stop the engine the throttle should be closed and the cylinder cocks then opened. The throttle may be closed quickly without injury to the boiler or the cylinder, providing there is plenty of water in the boiler. Close all lubricators. The cylinder cocks should be left open until after the engine starts again. If the engine is stopped for only a short interval, the cylinder walls will cool off so little that the engine can be quickly started. It is not well, however, to start the engine into full speed at once. This throws too much strain on the working parts.

**546. Leaks.**—Engines should be occasionally tested for steam leaks past the valve or the piston. The easiest and surest method to do this is to use the indicator, but wherever this is not possible the valve can be tested by placing it in its central position and turning on steam.

If there is any leak, condensed steam will flow from the cylinder cocks.

If the valve is tight, leaks past the piston may be found by blocking the crosshead so as to hold the piston in one place, then turning steam into one end of the cylinder. If water comes from the cylinder cock in the other end, steam is leaking past the piston.

It is well to make this test for both ends of the cylinder and with the piston in two or three positions. Sometimes the piston rings will allow the steam to pass one way and not the other. Often there are irregularities in the inside surface of the cylinder, and steam will leak past the piston when it is in one part of the stroke and not in another. Although a small leak may not appear very important, all the steam which leaks past the valve or the piston passes off into the exhaust without doing work. When the valve leaks it should be taken out and scraped to a fit. If the piston leaks, new rings should be put in, and if it continues to do so, the cylinder should be rebored.

**547. Packing.**—There are two classes of packing, piston packing and sheet or gasket packing. The former is to be used where moving parts are to be packed, such as piston and valve rods. It generally consists of some sort of wicking, such as candle wicking, asbestos wicking, hemp wicking, or patent wicking. Candle wicking and hemp are good all-purpose packings, but should not be left in the packing box too long, as they will become hard and cut the rod. Asbestos wicking is good packing for all purposes but pump rods. It does not get hard like hemp or candle wicking, but the water on a pump rod soon washes it out. Patented packings will last longer and not get hard like the common packings. Gasket or sheet packings are used on pipe fittings, manholes, and

handholes, where there is no motion. Such packing should be just thick enough to cover the uneven surfaces and no more.

**548. Pounding.**—An engine which pounds is generally loose or worn, and if permitted to continue pounding will gradually become worse. The wrist and crank bearings are those most likely to pound. Nevertheless, there are so many other places where the engine will pound that it is well to look not only at these points, but at others. An experienced engineer will have no trouble in detecting the exact place, but a new man should work cautiously. He should block the crosshead, and then turn the flywheel backward and forward an inch or two. This will tell whether the pound is in the flywheel, main bearings, crank pin or wrist pin. This will not tell, however, if the pound is in the governor belt pulley, or guides. A new engineer should not try to take out all of the pound at once; only take up the slack a trifle at a time until it is all removed. It is better to run a box too loose and have it pound than too tight and have it cut. An engine may also be loose in the eccentric and valve, and cause pounding, or sometimes it will pound when out of line. In the former case a little tightening will remove the pound; not too much, however, or the eccentric may cut or the valve bind. If the engineer thinks the shaft is out of line, he can detect it by taking the front half of the crank bearing off the connecting rod, and then by inspection see if the connecting rod freely rests in its position in the crank pin in all parts of the stroke of the piston.

**549. Bearings.**—All important boxes and those which are likely to wear should be made in halves with liners between the halves. This permits of taking up the wear, without requiring a new bearing. The ideal bearing is

a perfectly round hole with a pin fitting it just close enough to allow a film of oil between the hole and the pin. The closer a bearing can be made to conform to this the better.

As a bearing wears, a thick liner should be taken out and a thinner one inserted. Never take out a thick liner and then only partly draw up the boxes. This makes a loose bearing and will cause trouble.

**550. Lubrication.**—Since the cylinder of the engine is always hot when running, oil is required which will stand higher temperatures than the oils for bearings. This oil is generally known as cylinder oil. As a rule, it is a heavier and blacker oil than is generally used for lubrication. It is of such a nature that it will stand the heat in the steam chest and the cylinder. Ordinary lubricating oil would be decomposed by the heat. The oil used for bearings, such as crank, eccentric, wrist pin, etc., is of a lighter nature and is a good grade of common lubricating oil. A new engine requires more oil than an old one, and a cylinder when priming or foaming requires more oil than when running regularly. The amount of oil to use can be determined only by experience; it is better to get too much than not enough. A good method of determining the amount of oil for the cylinder is to keep track for a minute of the number of drops which pass through the lubricator; then take the cylinder head off and see if the walls are bright and shiny and feel oily; if so, the cylinder is getting enough oil. For bearings and other places, the number of drops a minute should be determined, and then the bearings watched to see if they heat and if there is an excess of oil running off.

**551. Lubricators.**—Owing to the pressure in the steam chest of an engine, some device has to be employed which

will force the oil into the steam pipe against this pressure. There are several makes of lubricators on the market. Fig. 279 shows the principle of nearly all of them. This lubricator is so arranged that the steam condenses in the small pipe of the lubricator and forms a greater pressure on one side of the oil than on the other. This forces the oil from the valve to the steam

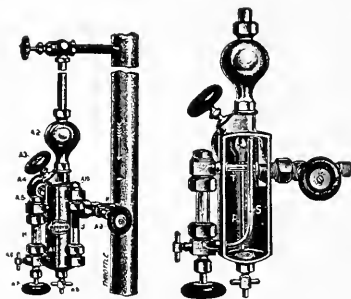

FIG. 279—CYLINDER LUBRICATOR

pipe. To fill the lubricator, the cocks from the steam pipe should be shut off so no pressure can be let in; then the small cock at the bottom of the lubricator should be opened and the condensed water let out. When oil commences to come instead of water the lubricator has been

drained enough. The cock can then be closed and the cap on top taken off and the oil poured in. Several makes of oil pumps now on the market are to take the place of the lubricator. They are actuated by a lever and arm from the crosshead. These pumps are more positive than lubricators in their action and not as likely to fail to operate. The only defect in this form of lubrication is that very few pumps have a sight feed or a glass which will tell how much oil is in the vessel that contains it; thus it is hard to tell whether the pump is full or empty.

## CHAPTER XX

### GAS, OIL AND ALCOHOL ENGINES

**552. Internal-combustion engine.**—The gasoline engine is of the type known as the internal-combustion engine. Others of this type are the gas engine, the hydrocarbon engine, the kerosene engine, the oil engine, and the distillate engine.

In the steam engine combustion takes place in the furnace; the heat is diffused through the boiler, generating steam; this steam is then transferred by means of pipes to the engine. Through all these operations a great deal of heat energy is lost by radiation. In the internal-combustion engine the fuel is put under high pressure by the inward movement of the piston. While in this condition it is ignited; the consequent burning causes a very great expansive force, and this force, acting directly upon the moving parts of the engine, gives very little opportunity for radiation.

The principle of all internal-combustion engines is the same, so in this chapter the gasoline engine will be used as a basis of discussion. The gas and the gasoline engine are so nearly identical that they may be treated in the same manner.

**553. Early development.**—At first the development of this engine was very slow. Huyghens in 1680 proposed the use of gunpowder. Papin in 1690 continued the experiments, but without success. Their plan was to explode the powder in an enclosed vessel, forcing the air out through check valves, thus producing a partial vacuum, causing the piston to descend by atmospheric pressure and





in 1876 the first engine of commercial value. All present-day types work on the same principle as Otto's, but under fewer practical difficulties.

**555. Types of gasoline engines.**—Otto was the first to put into practice the idea of compressing the gas and air mixture before igniting. This gave rise to the name of Otto cycle, which is now used in all engines. Compression is one of the important things which determine the economy of the engine; theoretically, the efficiency of the engine depends upon the compression pressure. However, it is not possible to increase the compression pressure indefinitely because the charge pre-ignites and causes the engine to pound. It is desirable, however, to use as high a compression as possible.

As stated before, practically all the engines used to-day are designed to follow the Otto cycle. However, they are divided into two distinct types, four-cycle engines and two-cycle engines.

**556. Four-cycle engines.**—The term cycle is applied to the entire operation of converting heat into mechanical energy. In the four-cycle engine four strokes of the piston

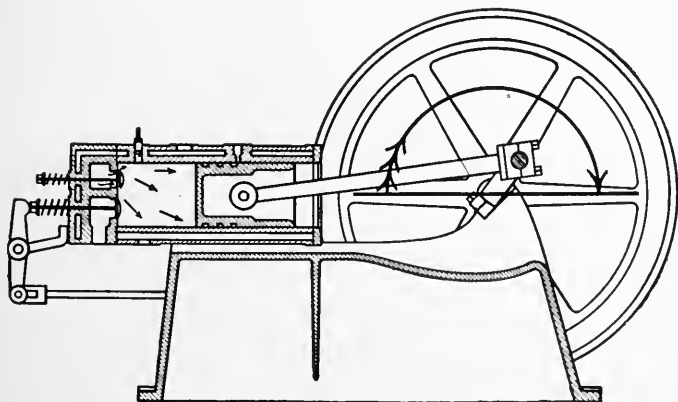

FIG. 281—SUCTION STROKE OF FOUR-CYCLE ENGINE

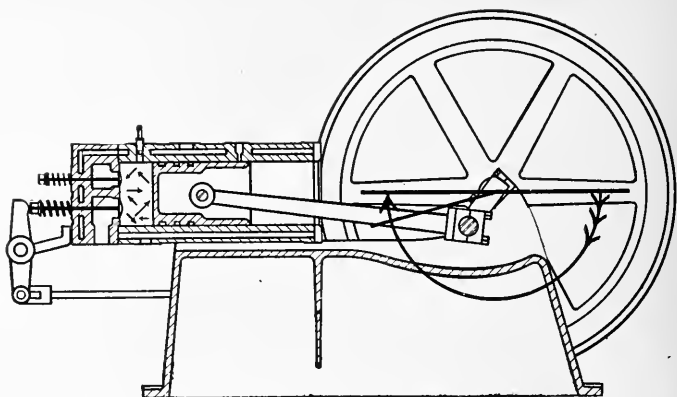

FIG. 282—COMPRESSION AND IGNITION STROKE OF FOUR-CYCLE ENGINE

or two complete revolutions of the crank are necessary to complete this cycle, hence the name four-cycle. These strokes may be enumerated as follows: The piston makes one forward stroke, drawing into the cylinder through the inlet a charge of fuel and air. This is called suction (Fig. 281). A second stroke compresses this charge

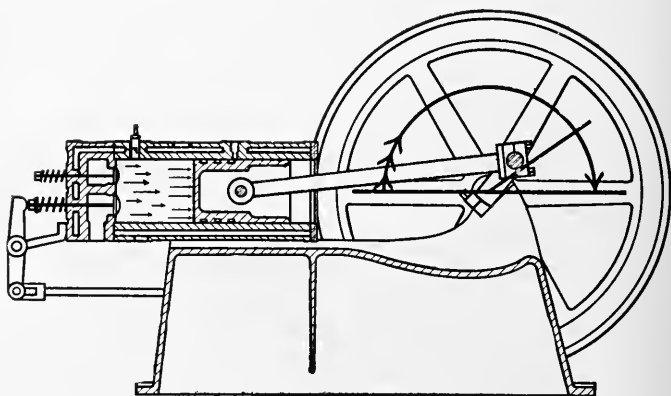

FIG. 283—EXPANSION AND RELEASE STROKE OF FOUR-CYCLE ENGINE

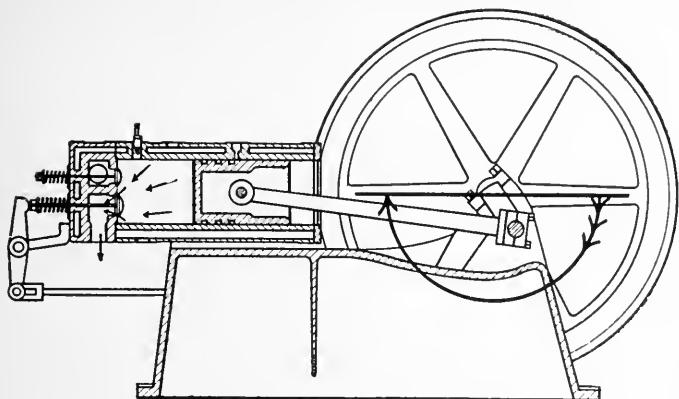

FIG. 284—EXHAUST STROKE OF FOUR-CYCLE ENGINE

into the clearance space of the cylinder (Fig. 282). This stroke is called compression. Just before the crank passes dead center the charge is ignited. Owing to the heat released, the gases expand, and this expansion of gases acts upon the piston, driving it forward during the third stroke, which is called expansion (Fig. 283). This stroke is the only working stroke of the cycle. During the fourth stroke the exhaust valve is forced open by mechanical means and the piston crowds the burned gases out. This stroke is called exhaust (Fig. 284).

**557. The two-cycle engine** completes the cycle in two strokes of the piston and from this fact derives its name. In this type of engine there must be, besides the cylinder, a compression chamber, which may be separate, which may be the crank case enclosed, or which may be the front end of the cylinder. To illustrate the cycle in this type of engine, the enclosed crank case type is used. That is, the cylinder and the crank case are both gas tight and practically in one piece. However, the two chambers are separated by the piston. Let the piston be at the crank

end of the cylinder, then start it up. This action tends to produce a vacuum in the crank case, but instead of doing so the charge rushes in through the check valve *A* (Fig. 285) and fills the space. Now start the piston down again, compressing the charge in the crank case (Fig. 286) until the piston has opened the inlet port, when the charge rushes from that end of the cylinder up

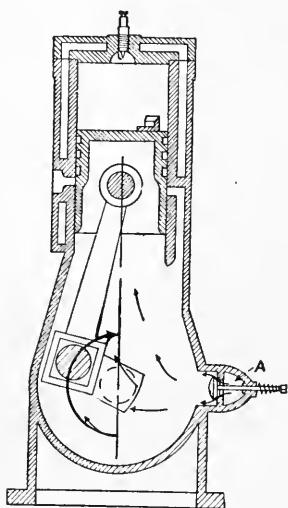

FIG. 285

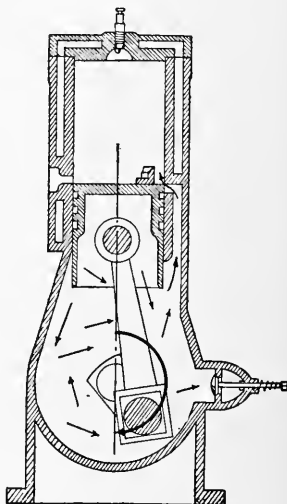

FIG. 286

into the other. As the piston starts back again (Fig. 287) it closes the openings and compresses the charge now in the head end. At the same time it is doing this a new charge is being drawn into the crank case. When the piston reaches the upper end of the stroke explosion takes place and the expansion forces the piston down (Fig. 288), compressing the charge in the crank case and expanding the one in the cylinder. When the piston has passed the

port openings the burnt gas rushes out through the exhaust port and the new charge comes in through the inlet port. Thus we see that when the piston is compressing a charge in the cylinder a new charge is being taken into the crank case, and when the charge in the cylinder is expanding the gas in the crank case is being compressed.

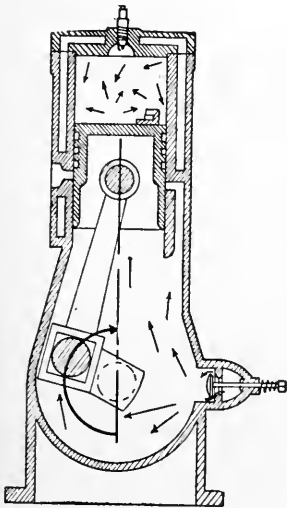

FIG. 287—SUCTION, COMPRESSION AND IGNITION STROKE OF TWO-CYCLE ENGINE

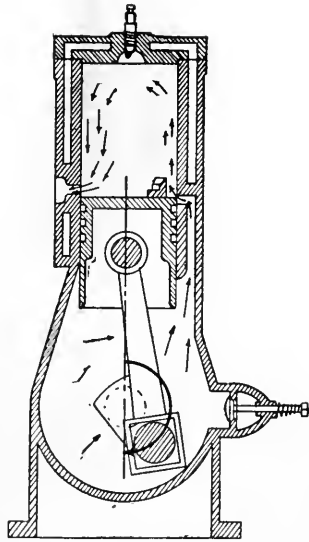

FIG. 288—EXPANSION, EXHAUST AND INLET STROKE OF TWO-CYCLE ENGINE

**558. Construction.** — (Only the four-cycle engine will be considered hereafter.) The parts of a gasoline engine necessary to be examined for proper construction are: cylinder head, cylinder, base, piston, and piston rings, connecting rod, crank shaft, flywheels, valves, governor, carburetor, ignitor, and cooling device.

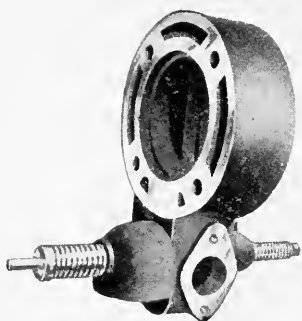

FIG. 289—CYLINDER HEAD

*Cylinder head.*—The cylinder head (Fig. 289) should have a device for cooling. If water is used for this, the inside of the head should be at least  $\frac{3}{8}$  inch thick for a 5-inch cylinder and the water jacket not less than  $\frac{1}{4}$  inch. These dimensions increase with the size of the engine.

*Cylinder.*—The cylinder (Fig. 290) should be bored perfectly smooth and round, and should be free from all flaws and imperfections. It may have the same thickness of castings as the head.

*Base.*—The base (Fig. 291) should be designed to carry the cylinder, engine frame, and flywheels in a well-balanced condition.

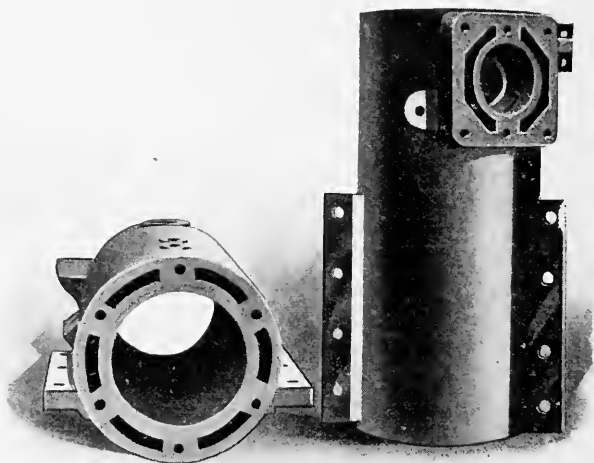

FIG. 290—CYLINDER

*Piston.*—The piston (Fig. 292) is one of the important parts of the engine. It should be of good length to carry itself without binding. The piston pin should be near the middle and as long and as large as possible. In

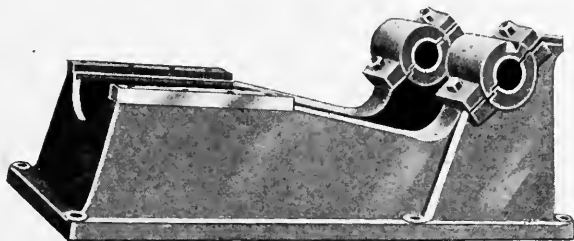

FIG. 291—BASE

small engines the piston should be about  $1/200$  of an inch smaller than the cylinder, and in larger sizes it should be about  $1/32$  of an inch smaller. The space on the head end of the piston beyond the last ring should be about  $1/16$  of an inch less in diameter than the rest of the piston.

*Piston rings.*—The number of rings (Fig. 292) varies from three in cylinders of 5-inch diameter and less up to eight in 20-inch cylinders. If the engine is of the



FIG. 292—PISTON AND RINGS

vertical type, there should be a ring at the lower end of the piston. This ring will prevent "oil pumping." The rings should break joints, and if one edge fits closer to the cylinder than the other, the close-fitting edge should

be toward the explosion end. All rings should be crescent-shaped. This causes an equal pressure all around.

*The connecting rod.*—The connecting rod (Fig. 293)



FIG. 293—CONNECTING ROD

should be of forged steel and of the right weight to carry the load. A simple bearing is sufficient at the wrist pin, but at the crank end the boxings should be held in place by means of two bolts. All parts should be in perfect alignment.

*Crank shaft* (Fig. 294).—It is essential that the crank shaft be heavy enough to withstand the sudden shocks which come to it from the explosions, and it should also carry the heavy flywheels without springing. The bearings should be long and in perfect alignment. Their line of centers must be exactly at right angles with the cylinder. A good way to detect a weak crank shaft is to notice whether the flywheels wobble at each explosion of the engine.

*Flywheels* (Fig. 295).—These are necessarily heavy and massive, but not necessarily ungainly in appearance. Loganecker says: "At a medium speed, which may be based on about 225 revolutions for 25 H.P. to 375 for 2 H.P., 100 pounds to the horse power will not be very far out of the way. The di-

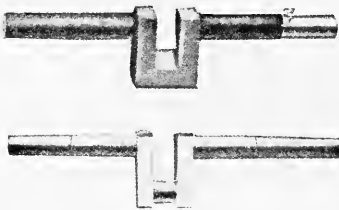

FIG. 294—CRANK SHAFT



anometer may range from 28 inches on the small engine to 60 inches on the larger size." The above weight is to be divided between the two wheels.

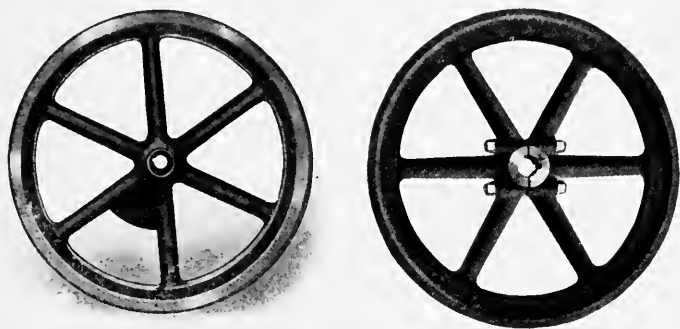

FIG. 295—FLYWHEELS

*Valves* (Fig. 296).—It makes no great difference where the valves are located, just so they are close to and connected to the clearance space. A good rule to follow for size is: Inlet valve diameter should be five-sixteenths diameter of the cylinder, and the exhaust valve about seven-sixteenths.

**559. Governors.**—There are two types of gasoline engine governors in general use. These are the **throttling** governor and the **hit-or-miss** governor.

*Throttling governors* vary the amount of gasoline mixture admitted to the cylinder. Before the engine has reached its normal speed, or when it is carrying a full load, each charge is a full charge, with as near a perfect mixture as possible. Consequently the normal compression pressure for that engine is attained and the engine does its work with its greatest economy. When the engine is doing only a part of its rated capacity of work, the throttle acts. This reduces the volume of mixture which enters the cylinder, but the space within the cylin-

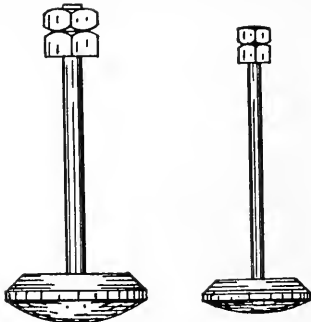

FIG. 296—VALVES

der to be filled is the same; consequently the compression pressure is not as great as it should be and the engine is not economical with fuel. Often the load in an engine is small enough for the charge to be throttled down until of such small volume as not to ignite, but simply pass off to the exhaust unburned. Throttling-

governor gasoline engines are not as economical with a variable load as the hit-or-miss type of governed engines. However, their motion is much more steady, and often the matter of economy is waived in order to secure the greater uniformity of speed.

*Hit-or-miss type of governor.*—In the hit-or-miss type of governor the amount of mixture drawn in for an explosion remains at all times a constant, and the governing is accomplished by cutting out all admissions while the engine is running faster than normal speed. This method of governing is usually accomplished by holding the exhaust valve open and the inlet valve closed until the engine falls a trifle below speed, when the exhaust valve closes and new charges are taken into the cylinder. Fig. 297 shows the manner in which this style of governing is accomplished. When the speed of the engine is above normal the governor sleeve *C*, which is in the crank shaft, is drawn out, and, acting on the detent roller *D*, throws the detent lever *E* down so it becomes engaged in the hook-up stop *F*. The hook-up stop *F*, being connected to the exhaust valve rod *H*, holds the exhaust valve open. By reference to Fig. 298 it will be seen how

the inlet valve is held closed. There are three general methods of using weights to accomplish hit-or-miss gov-

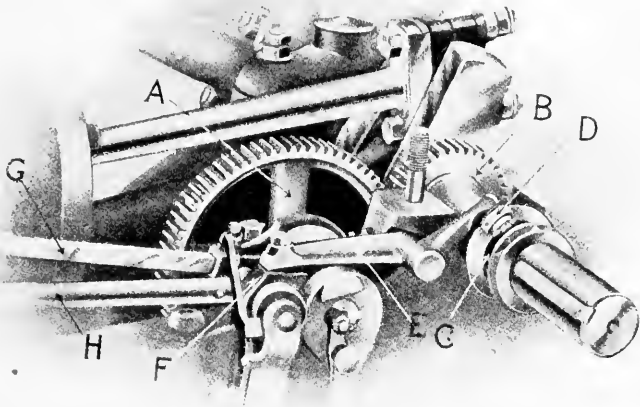

FIG. 297—MECHANISM FOR HIT-OR-MISS GOVERNOR

erning as explained above. They are: By having weights in the flywheels (Fig. 299); by having weights in a special shaft (Fig. 300); and by means of an inertia weight

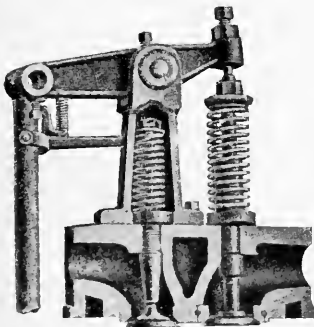

FIG. 298—INLET VALVE LOCK

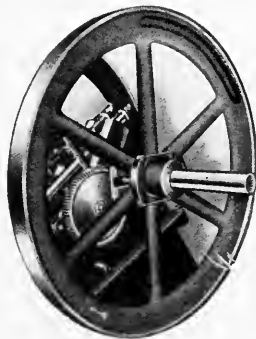

FIG. 299—FLYWHEEL GOVERNOR

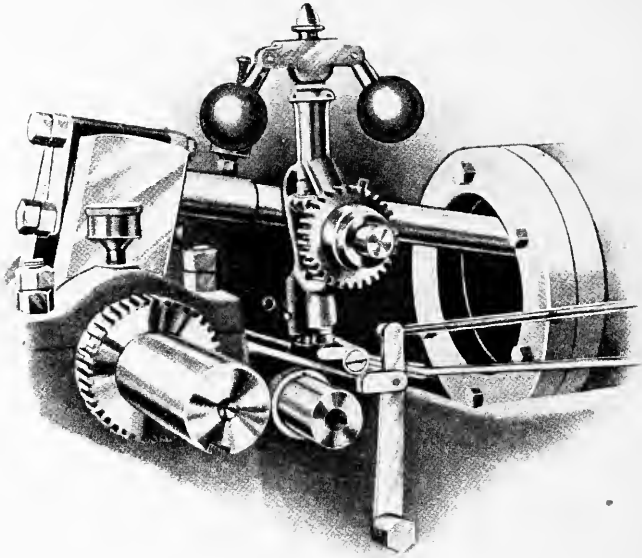

FIG. 300—BALL GOVERNOR

(Fig. 301). The latter type of governor works on the principle that when the engine is running at normal speed the weight does not get enough throw to cause the detent to catch in the hook-up stop, but when the speed is increased above normal the weight is thrown far enough to accomplish this.

**560. Carburetor.**—Before gasoline can be used in an engine for fuel it must be converted into a vapor or into a gas. This process of converting the liquid into a gas is called **carburetion**, and the device by which it is accomplished is called the carburetor. It is by means of the carburetor that a proper mixture of gasoline and air is made for combustion in the cylinder. A proper mixture is one of the important functions of successful gasoline engine operation.

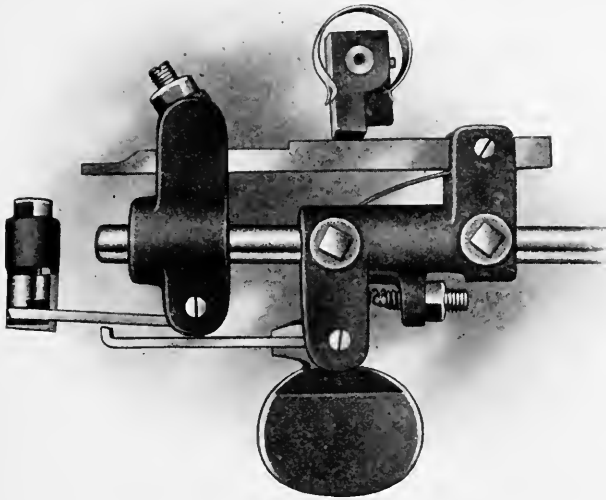

FIG. 301—PENDULUM GOVERNOR

When the liquid gasoline is converted into a vapor its volume is increased about 1,500 times. To make a strong explosive mixture the vapor must be diluted from 8 to 13 times the volume of the air; the air in this case supplying the oxygen. Thus we see that the volume of gasoline to

the volume of air used is in the proportion of about 1 to 12,000 or to 19,500. It follows that the carburetor must necessarily be a very delicate arrangement. An engine will not run satisfactorily unless the mixture is very nearly correct. There is a multitude of surface, wick, gauze, spray, atomizing and float-feed carburetors and generator valves on

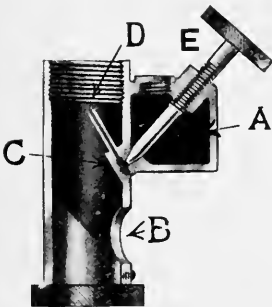

FIG. 302—PRINCIPLE OF THE CARBURETOR

the market. Practically all of these devices depend upon the liquid fuel being caught by the incoming air and atomized on its way to the cylinder. Fig. 302 illustrates the principle of the carburetor. Gasoline flows into the chamber *A*; air enters at *B* and passes through the chamber *C* into the engine cylinders. As the air passes the tube *D* it takes up the charge of gasoline which has been admitted through the needle valve *E*, and carries it on into the engine with itself. Since the air passes the tube *D* at a velocity of about 6,000 feet a minute, it immediately atomizes the gasoline and forms it into a gas. Fig. 303 is a commercial carburetor wherein

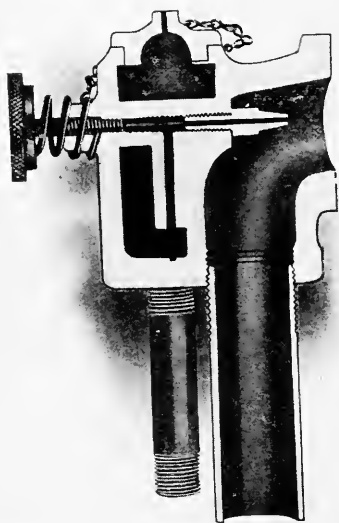

FIG. 303—CONSTANT-LEVEL CARBURETOR

the gasoline is kept at a constant level in the reservoir. Fig. 304 shows a float-feed carburetor, the principle of which is illustrated in Fig. 305. As fast as gasoline is taken from the tube *A* the float *B* drops and more gasoline enters the reservoir *C*.

The charge of gasoline taken into the engine each time is so small that the amount can be regulated only by a needle valve. Such valves as are used about the pump are far too large. It is also due to this minuteness of the charge that the gasoline has to be kept at a constant level in the reservoir of the carburetors. For instance, if the carburetor illustrated in Fig. 303 has no overflow, but the attendant endeavors to regulate the amount of gasoline in the reservoir by means of the valve in

the feed pipe, he will set his valve so that the engine runs well under a full load, but when the load becomes less fewer charges will be drawn in and the pump will throw the same amount of gasoline. Consequently the reservoir will fill so full that when the engine does take a charge there will be so much gasoline in it that there will not be complete combustion, and as a result the explosion will be weak and the exhaust gas will be black smoke. The carburetor should be near the cylinder to enable the mixture to be easily controlled.



FIG. 304—FLOAT FEED CARBURETOR

**561. Ignitors.**—There are two general types of ignitors.

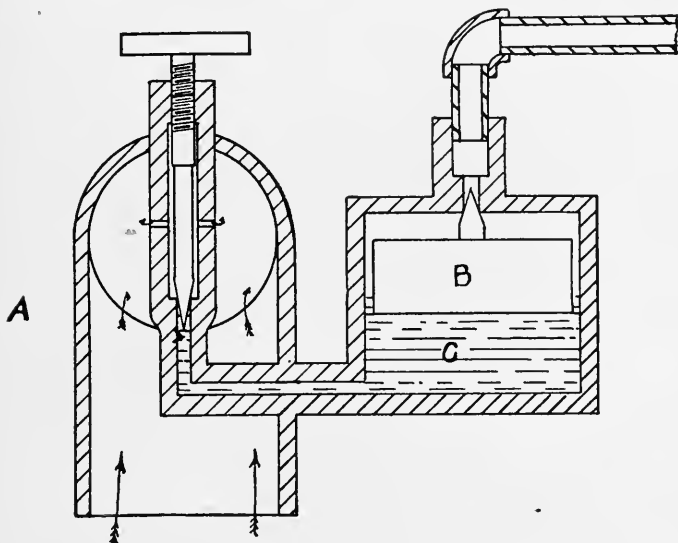

FIG. 305—PRINCIPLE OF THE FLOAT-FEED CARBURETOR

the **hot tube** and the **electric spark**. The latter type, which is most popular in America at present, may be divided into two classes, the **contact spark** and the **jump spark**.

*Contact spark* (Fig. 306).—It has been noticed that when a break is made in an electric circuit a spark takes place, and it is upon this principle that the contact gasoline ignitor depends. The charges of the fuel mixture

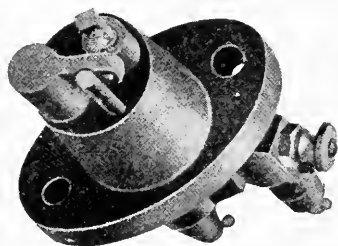

FIG. 306—CONTACT-SPARK IGNITOR

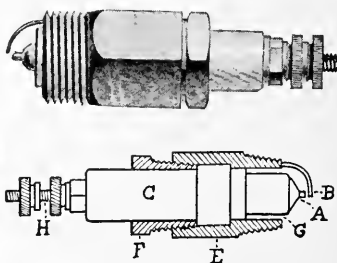

FIG. 307—JUMP-SPARK IGNITOR

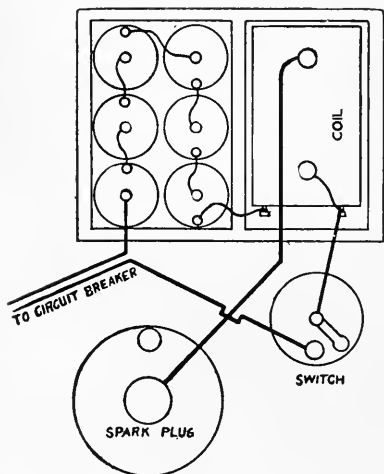

FIG. 308—WIRING SYSTEM FOR JUMP-SPARK IGNITION

are ignited by causing this break to be made inside of the cylinder. The quicker this break is made, the more pronounced the spark. The spark is always made larger and more pronounced by including in the circuit a spark coil.

*Jump spark*.—The jump-spark ignitor (Fig. 307) has within the cylinder two points insulated from each other and separated by



a very short distance. It differs from the contact-spark circuit in that there must be an induction coil. This coil requires a primary current leading to it from the batteries, and a secondary current leading to the spark points. This latter current has the characteristic of jumping from one point to the other in the form of a spark, thus igniting the charge in the engine (Fig. 308).

**562. Batteries.**—In the majority of cases the currents for electric ignitors are furnished by batteries composed of either dry or wet cells. It is very difficult to determine without the aid of proper instruments when a battery has been exhausted to the point where it does not furnish sufficient current. Upon trying an exhausted battery out, it will in all cases give a satisfactory spark. This is due to the fact that batteries when exhausted tend to recover slightly during the rest and are able to furnish current for a few ignitions. Upon starting an engine with

an exhausted battery, a few ignitions will take place satisfactorily, but later it will miss fire, due to the weakness of the battery. Often when a battery is becoming run down and the engine is still running the latter will take in several charges, but no explosion will result; then there is an

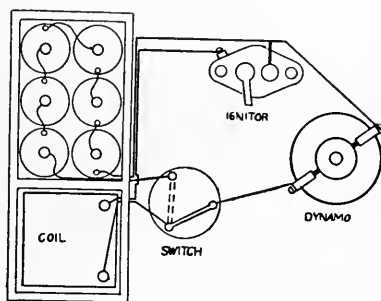

FIG. 309—WIRING SYSTEM FOR BATTERIES AND DYNAMOS

explosion and a great report from the exhaust. This is because the explosion in the engine ignites the unexploded charges which have previously passed through into the exhaust chamber.

**563. Dynamos and magnetos.**—Since the battery is expensive and short lived, other provisions are made for supplying electric currents. One of the most satisfactory of these is by connecting the engine to a form of magneto or dynamo. The amount of power needed to drive a dynamo is exceedingly small, but at all times sufficient current is provided to give reliable ignition. A magneto differs from a dynamo in that the pole pieces of the magnetos are made of permanent magnets, while those of the dynamo are electromagnets.

It is often easier to start an engine with a magneto than with a dynamo. However, after speed is reached, the dynamo, as a rule, is a little more satisfactory than the magneto. These small dynamos are usually provided with a self-governing device which will regulate the speed and in this way obtain the proper voltage for ignition.

**564. Cooling of gasoline engines.**—There are three methods of carrying the excess heat away from the gasoline engine cylinder, namely: (1) air cooled; (2) water cooled; and (3) oil cooled.

*The air-cooled engine* (Fig. 310) is provided with ribs or flanges extending from the cylinder, which gives up a certain amount of heat to the air. This may be assisted by a draft of air blown upon the cylinder by a fan, bringing more air in contact with the flanges. Air-cooled engines are necessarily of small units, but where the engine is small and exposed to freezing weather it is preferable to any other.

*Water-cooled engines* are the type in most general use, and water is perhaps the best means of carrying the excess heat from the cylinder. There are three general plans in use for cooling with water. One is to have a large tank sitting near and connected to the engine (Fig.

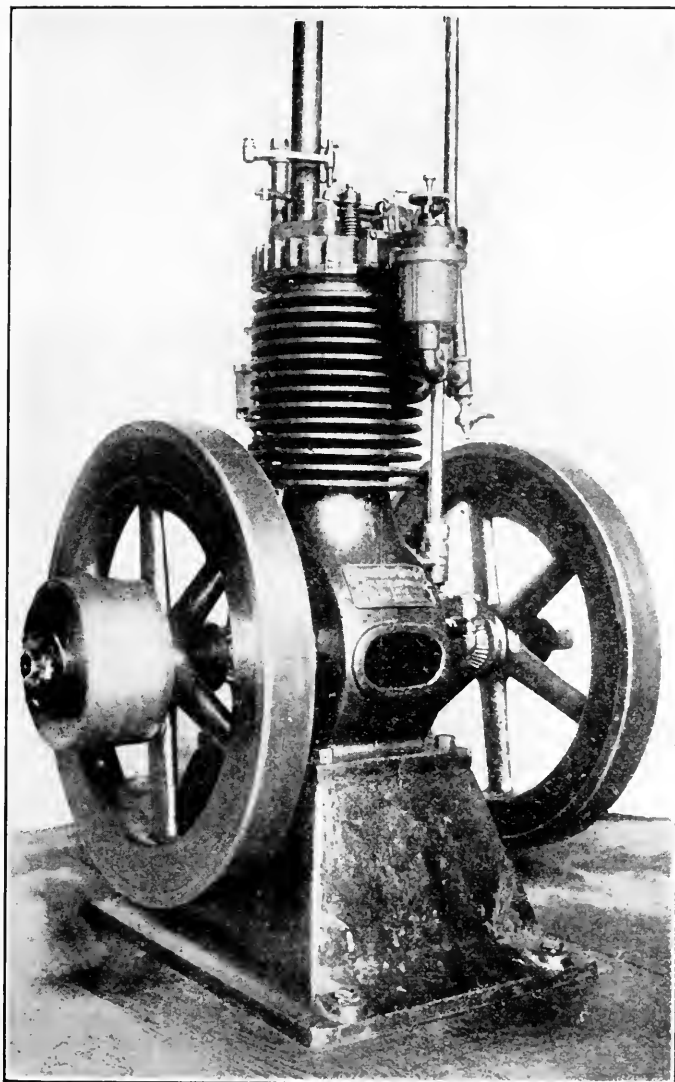

FIG. 310—AIR-COOLED ENGINE

315). One connection should be from the lowest part of the water jacket to the lower part of the tank; the other should be from the upper part of the water jacket to the top of the tank. The heat from the engine causes circula-

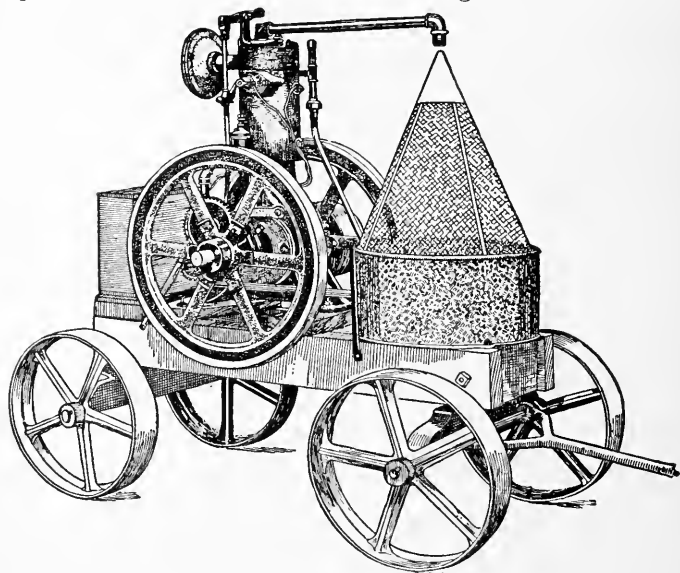

FIG. 311—CIRCULATING PUMP SYSTEM OF COOLING

tion similar to that in a boiler. Another plan (Fig. 311) is to provide some way for the water to fall through the air and thus cool itself by evaporation. In this plan a circulating pump is necessary. The third method is to allow a stream of water to run continually through the engine. The first way is the most economical and possibly the most satisfactory where there is plenty of room and no danger of frost. The second method is coming into general use because it takes less space and does not require so much water at once. All late portable engines are equipped with this device for cooling. For stationary

engines and where the amount of water used may be unlimited, the constant-flow method is considered the best, since by this means the water can be drained from the jacket every time the engine is shut down, and turned in again upon starting, and thus avoid the danger of freezing.

*Open-jacket cooling.*—Engines are now coming upon the market which have the open-jacket method of cooling. The casting for the water jacket is extended so it forms a reservoir upon the top of the engine (Fig. 311a). This reservoir is open at the top and holds but a few gallons of water. As the engine heats, the water is allowed to boil and evaporate. Since there is only a pailful or so of

water in the engine, it is but a small matter to drain the engine and then refill in cold weather.

*Oil cooling system.*—By having a radiator and circulating pump, oil is used for cooling where engines are exposed to freezing temperature.

Often chemicals are used in water to prevent freezing. Calcium chloride is the most common of these. The proportions generally used are 5 pounds of the chemical to 10 gallons of water. Whenever possible, the use of chemicals should be avoided; they attack

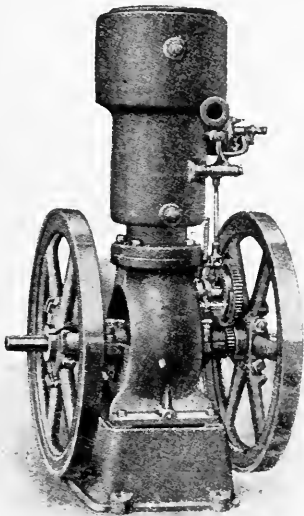

FIG. 311A—OPEN-JACKET SYSTEM OF COOLING

either the tank or the engine castings.

**565. Gasoline engine indicator diagram.**—The highest pressure obtained in the average steam engine cylinder rarely exceeds 175 pounds to the square inch. In gasoline engines the average maximum pressure is about 300 pounds a square inch, and it often exceeds 400 pounds a square inch. Since the pressures are so high in the gasoline engine, either the spring has to be made stiffer in the indicator or else the piston made smaller. Either method is utilized with success in indicator work. All parts of the gasoline engine indicator, excepting the spring, are the same as those of the steam engine indicator. In the steam engine the working fluid is admitted to the cylinder ready to perform its work on the piston. In the gasoline engine this is not the case. The working fluid enters the cylinder in the form of a gasoline fuel, which has to be compressed and burned before it is ready for use. Since these operations take place in the engine cylinder, the gasoline engine indicator diagram is different from that of the steam engine. Fig. 312 is a typical gasoline engine indicator diagram and can be followed out thus: *XY* is the atmospheric line; *ABC* is the line produced by the suction stroke of the piston; *CDE* is the compression line; *E* is the point of ignition; *EFG* is the line produced by the increase in pressure as the gas burns; *GHI* is the expansion stroke line; *I* is the point of release; *IC* is the exhaust line and *CJA* is the exhaust stroke line. If the inlet valve is opened automatically the suction stroke line falls far below atmospheric pressure, but if it is opened mechanically the line *ABC* will fall only a short distance below the line *XY*. The indicator diagram shows as clearly what is the matter with a gasoline engine as it does with a steam engine. Fig. 313 shows cards from engines where ignition is too late; Fig. 314, cards which indicate too early ignition.

**566. Losses in a gasoline engine.**—If it were possible to utilize all the heat in the fuel in a charge of gasoline, there would be no more economical method of producing power, but the mechanical difficulties which have to be overcome are so great that only about 25 per cent of the fuel is converted into applicable work. The principal losses of a gasoline engine are: radiation of heat, heat passed off in the exhaust gases, and heat lost by leakages. At the instant explosion takes place in the engine cylinder the temperature at the center of this explosion is esti-

mated to be about  $3,000^{\circ}$  F. Since cast iron melts at about  $2,300^{\circ}$ , a great deal of the heat of the explosion must be immediately carried off by radiation through the walls of the cylinder. In order to utilize all the heat left in the gases after the loss by radiation is deducted, the

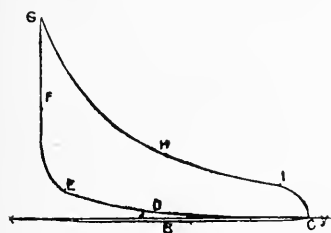

FIG. 312

cylinder would have to be so long that the gases could expand to atmospheric pressure. This is a mechanical impossibility. And it has been decided that the most practical length of cylinder is such that the stroke of the piston is about twice as long

as the diameter of the engine cylinder. Under these conditions the pressure at release is generally about 40 pounds, and the exhaust gases are still hot enough so that they produce a dull red flame. These two losses are the greatest; and the third loss, that is, the loss past the piston rings, is due to the fact that it is impossible to have a joint between moving parts perfectly tight.

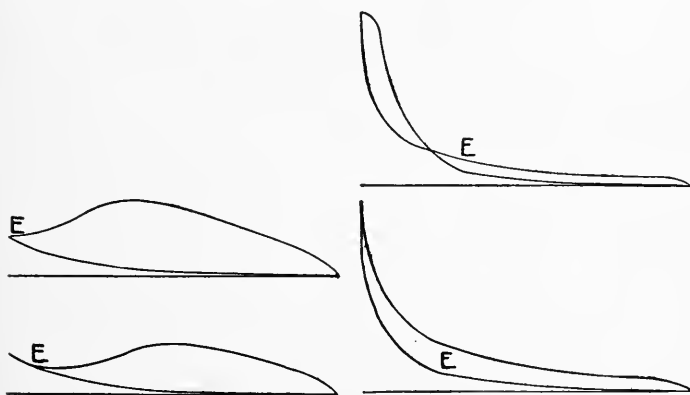

FIG. 313—TOO LATE IGNITION

FIG. 314—TOO EARLY IGNITION

**567. Indicated horse power.**—The formula for indicated horse power in the gasoline engine is:

$$\text{H.P.} = \frac{\text{PLAN}}{33,000},$$

where

- P = mean effective pressure,  
 L = length of stroke in feet,  
 A = area of piston in square inches,  
 N = number of explosions a minute.

It will be seen that this formula is the same as that for steam engines, excepting that N represents the number of single explosions a minute in the gasoline engine formula, instead of the number of revolutions a minute, with two impulses for each revolution, as in the steam engine.

**568. Testing.**—To make a complete test of a gasoline engine requires a great deal of expensive apparatus. Not only is this apparatus needed, but the one doing the testing must have a very good knowledge of science as far as it pertains to heat and engines. However, a very simple apparatus can be arranged so that any farmer, if he cares to take the trouble, can make a test which will cover all matters as far as he is concerned. The formula for B.H.P. is the same as that given in Chapter I. for steam engines, and the same brake can be used. A speed indicator can be procured for a dollar, and a set of scales or spring balances can be easily secured. It will require two men, who must work simultaneously. Before starting to make the test it will be well to draw up a form about as follows:

Test	1	2	3
Name of engine.....			
Rated horse power.....			
Weight of brake on scales, engine still.....			
Weight on scales, engine loaded.....			
Net brake load ( <i>G</i> ).....			
Length of brake arm in feet ( <i>A</i> ).....			
Revolutions per minute ( <i>N</i> ).....			
Horse power from test.....			



Before the engine is started, weigh the brake on the scales with the friction part on wheels ready for the test. Measure the distance from the center of the wheel to the point where the brake rests on the scale. In a rope brake the brake arm is the radius of the wheel plus half the thickness of the rope.

When everything is ready start the engine and gradually draw up the brake. A gasoline engine is running at full load when it misses only one explosion out of about every eight. Tighten the brake until this point is reached, then run the weight out on the scale beam until the point is reached where it balances. Now let one man keep the scales balanced by tightening and loosening the brake; at the same time let the other man take the speed of the engine for one minute. This is all the data needed to determine the brake horse power. It is well, however, to keep the brake on with engine running at full load for at least 15 minutes to determine whether the engine will carry the load.

**569. Care of gasoline engines.**—In the care of the engine there are three points of equal importance, namely: cleanliness, water, and oil. To secure the first a well-lighted room is required, one in which the engine alone is placed. Damp, dark cellars should be avoided. As to water and oil, the consideration given depends entirely upon the man in charge. If the engine room is light, the floor clean, waste in a can, tools in a case, and engine bright and clean, it is a certainty that its bearings do not cut for the want of oil, nor its water jacket run dry or freeze up.

A person who does not understand the engine should refrain from tampering with it as long as it runs well. During this time he should be observing and notice the workings of all parts so that in case the engine is not working satisfactorily he can readjust it.

**570. Lubrication.**—Lubrication of the gas engine cylinder is very important. A special oil must be used to stand the high temperature met with in gas-engine practice. Any oil containing animal fat will not work at all because when subjected to high temperature it will decompose and be reduced to a charred mass. First-class steam engine cylinder oil will not give good results because it contains certain elements which will carburet like gasoline under high pressure and high temperature. Good engine oil is satisfactory for other parts.

**571. Gasoline engine troubles.**—The gasoline engine is often condemned as being unreliable. This may be explained from the fact that unless conditions are just right the gasoline engine will stop or refuse to work at all. This is different in other forms of motors because very often the thing which interferes with its operation comes on gradually and may not be noticed by the man in charge. It has been stated that "there are four things essential to the operation of a gasoline engine," namely: compression, ignition, carburetion or proper mixture, and proper valve action. If these four conditions are obtained, the engine will work or run. If there is failure to obtain any one of them, the engine will refuse to run. Often an engine will stop, and it is difficult to tell which one of the various conditions is wrong. It is necessary to trace the trouble and correct it.

**572. Compression.**—It is easy to detect whether or not there is compression by turning the engine over; if a charge of air is caught and compressed; this is an easy matter to determine. Failure to get compression may be due to a valve refusing to seat or to a leak past the valve. It may also be due to a leak past the piston, to broken piston rings, poorly seated rings, or rings gummed with oil. If valves do not seat correctly, it may be due to

some gum or scale under one side of the valve. If they leak, it may be due to the fact that the valve seat has become worn owing to excessive heat, in which case they must be reground. If there are broken rings, they must be replaced with new. If poorly seated, new rings must be fitted to the cylinder. If they are gummed up so they will not spring out against the cylinder walls, they may be oiled and loosened with kerosene.

**573. Ignition.**—The majority of the gasoline engine troubles may be laid to the ignitor. As stated before, it is often very difficult to pick out the trouble with the ignitor in the case of a battery which has been exhausted.

If for any reason the operator thinks the spark fails to pass on the inside of the cylinder, the wire on the insulated terminal should be disconnected and snapped on some bright part of the engine. If there is a spark, it proves that as far as the battery is concerned everything is satisfactory. If there is none, the wire should be thoroughly gone over, the trouble located, and a spark obtained. Perhaps it will be found that a binding screw is loose, or the circuit has been broken at some other point. If the operator gets a spark in the above manner, and then snaps the wire across the insulated binding post, obtaining a spark, there is a connection between the points within the engine, and the ignitor must be removed and cleaned. If by making this test there is no spark, it indicates that there is no circuit between the ignitor points, and the operator should now hold the points together within the engine, by means of the ignitor dog, and snap the wire across the insulated terminal. This time a spark should be obtained, but if not, it indicates that there is insulation between the points, which must be cleaned after the ignitor is removed. Water and carbon will make a circuit between the points, while oil

and rust will prevent contact. Any of the above substances between the ignitor points will prevent a spark. The point of ignition varies with the speed of the engine. On a slow-speed engine, one of about 225 revolutions a minute, ignition should take place when the crank is  $10^{\circ}$  or  $15^{\circ}$  before center. This angle increases as the speed of the engine increases until in an engine running about 700 revolutions a minute the angle is from  $35^{\circ}$  to  $40^{\circ}$ .

To locate ignition troubles is merely a matter of disconnecting certain parts of the circuit and locating the trouble by elimination.

**574. Carburetion.**—If for any reason the carburetor refuses to give a proper mixture, the engine will refuse to run. In this case it is necessary for the operator to assure himself that everything else is correct, then clean out the cylinder by turning the engine over several times and beginning as if he were starting the engine for the first time. A too rich mixture is detected by black smoke appearing at the exhaust. A too poor mixture is determined by a snapping sound from the exhaust, indicating that the mixture is slow-burning and is still burning when the exhaust valve opens. The gas engineer determines whether or not his engine is running properly largely from the sound of the exhaust.

**575. Action of valves.**—The valves now used on the gasoline engine are all of the poppet type and give a quick opening. An engine will not run if the valves are not properly timed. The inlet valve is operated by suction; however, a little greater efficiency is obtained by having this valve open mechanically, as there is less opportunity for the charge to be throttled during admission. The exhaust valve is always opened mechanically, and should open about  $45^{\circ}$  before the beginning of the exhaust stroke, closing at the end of the stroke.



and the former when muffling effectively generally cause back pressure and consequently loss of power. The most satisfactory method of reducing this noise is to pipe the exhaust into a pit, old well, or smoke stack. The top of the pit or well should be closed, with the exception of three or four openings the size of the exhaust pipe.

**577. Setting.**—To insure a smooth-running gasoline engine, the setting is a very important point. Fastening to the ground by means of stakes and skids or to a floor by means of lag screws are makeshift methods. A masonry foundation with well-set anchor bolts is by all means advisable. Well-laid concrete is the best and generally the cheapest. The foundation at the bottom should be about twice the length of the base of the engine and a little more than twice the width. For an engine of 5 to 12 horse power it should be from 3 to 4 feet deep, and for larger sized engines from 5 to 6. The sides should be battered until they are about 8 inches wider at the top than the engine. The jar is to a certain extent broken by having heavy planking between the masonry and the engine. To set and hold the anchor bolts in position, a templet should be made which contains holes corresponding exactly to those in the engine bed. The templet should be made strong and firm. The bolts need a heavy washer or plate at the lower end and should be passed up through a pipe which has an inside diameter of not less than 1 inch. This gives a chance for variation in setting.

**578. Advantages of the gasoline engine as a farm motor.**—The gasoline engine has many advantages over the steam engine. In the first place, the farmer as a rule uses power for short intervals. The gasoline engine is always ready to start, and when the run is over there is no fuel in the fire box to be wasted. It does not require

an hour's time to get up steam. Not only is there a waste of fire in the fire box, but the steam boiler when under steam contains a large amount of energy, and on cooling down this must all be wasted.

In regard to the matter of safety the gasoline engine has the advantage again. There is practically no danger from explosion with it, for, as was stated, there is not a large amount of energy stored up which may be suddenly released to cause an explosion. Usually the supply tank is placed outside the building, buried in the ground, so the danger from fire is reduced to a minimum. Steam boilers must have an attendant, lest the water get too low and burn the crown sheet, or become too high so water is carried over into the cylinder and knock the cylinder head out. The fire has to be fed continually and the grates cleaned, so that an attendant is needed practically all the time. Such close attention is not needed with gasoline engines.

The gasoline engine is as portable as the steam engine. As to furnishing its own traction, there are several gasoline traction engines on the market, and there is no reason why with the addition of clutches and variable-speed devices the gasoline engine cannot be made as reliable an engine as the steam traction engine. In proof of the fact that it may be made to furnish its own tractive power it is only necessary to refer to the automobile, which is made to work under great variance of speed.

In regard to the cost of power from gasoline and coal, each has advantages under certain conditions. The average consumption of gasoline per horse power per hour should be about  $1/6$  or  $1/7$  gallon, with a minimum of  $1/10$  gallon. The coal consumed per brake horse power per hour is about 8 pounds, with a minimum near 4 pounds as burned under boilers to furnish steam for farm

engines. It is possible to figure just what the running expense will be if the cost of the two different kinds of fuel be at hand. Under ordinary conditions and for very small units the gasoline engine will without question be the cheapest. In dairy work, steam direct from the boiler or from the exhaust is used to heat water for washing purposes, and this is a great advantage for the steam plant. However, the jacket water heated with the exhaust of a gasoline engine might be used in the same way.

The steam engine as built for farm use is capable, at the expense of economy, of carrying a very heavy overload. This is extremely advantageous in traction engines in case of emergencies. A 25-horse steam traction engine is often able to develop 60 brake horse power. Gasoline engines are rated very nearly their maximum power, and are not able to carry a large overload.

The troubles with steam engines usually come on gradually, and the attendant is able to observe what is wrong before the engine is stopped. With the gasoline engine, if anything goes wrong the engine stops at once. All conditions must be right in the gasoline engine or it will not run.

**579. The future of the gasoline engine.**—Gasoline engines will no doubt be used more and more as time goes on, as they are especially adapted to the farmer's needs. The gasoline engine is a power plant within itself. It can be manufactured in almost any sized unit, and a suitable size can be produced for all manner of farm work from the light work of running grain separators to a motor large enough to run a threshing separator. If gasoline as a fuel becomes too expensive, there is a possibility of a substitution of other liquid fuels in this type of engine.



Engines may be designed to use a heavier kerosene oil, and also alcohol. By the addition of a gas producer, power may be obtained from coal by the use of a gas engine. The internal-combustion engine is the most efficient of all engines; that is, a larger per cent of the heat is converted into mechanical energy than by any other form of prime mover. The efficiency of a steam plant is seldom more than 12 per cent; that of a gasoline engine is not far from 20 per cent. Alcohol works about as well in the gasoline engine as gasoline. The only difficulty to be had is in starting, as alcohol does not carburet as easily as gasoline. As a rough estimate, four gallons of alcohol are equal to three gallons of gasoline.

Alcohol is now manufactured in Germany at about 18 cents a gallon. It is claimed that alcohol can be manufactured as a by-product of sugar factories for as low as 10 cents a gallon. Thus we can feel sure that if gasoline ever becomes so scarce and expensive as to prevent its use upon the farm, we may substitute for it a fuel which may be produced upon the farm itself.

There is a marked advantage in the use of alcohol in that higher compression pressure may be used without pre-ignition. This tends to increase the efficiency of the engine. It is thought that the time will come when every farm will be provided with a power plant in which an engine of the internal-combustion type will be installed.

## CHAPTER XXI

### TRACTION ENGINES

**580. Traction engines.**—The steam boiler and the steam engine have been considered separately. If the two should now be combined by means of a steam pipe and placed on skids or trucks they would be termed a portable steam engine. A gasoline engine placed on skids or trucks is known as a portable gasoline engine. Such engines are not self-propelling, but have to be moved by means of animals or some mechanical device. The traction steam engine is the boiler, engine, and propelling device all in one. The traction gasoline engine is the engine and propelling device combined. In other words, the traction engine develops the power by which it moves itself over roads, fields, etc. The action of the traction engine is to convert energy into horizontal motion which has no direct path; that is, the heat from the fuel is transferred from the boiler to the water, then from the water to the steam pipe, and from the steam pipe to the engine, where it is changed from heat energy to mechanical energy. The mechanical energy is then transferred from the engine to the clutch, thence to the drive wheels, which propel the combined unit over its path. The gasoline traction engine is similar to the steam engine in part only and is considered by itself.

### ENGINE MOUNTING

In nearly all types of traction engines the engine is mounted upon the boiler, and the boiler is mounted upon the truck. There are now being made some engines

which are of the locomotive type, having the engine mounted beneath the boiler. These are known as under-mounted engines.

**581. Boiler mounting.**—There are four general methods of mounting the boiler. The most common method is to attach the drive wheels to brackets at the side of the boiler and is known as side mounting. Another common method is to mount the drive wheels on an axle at the

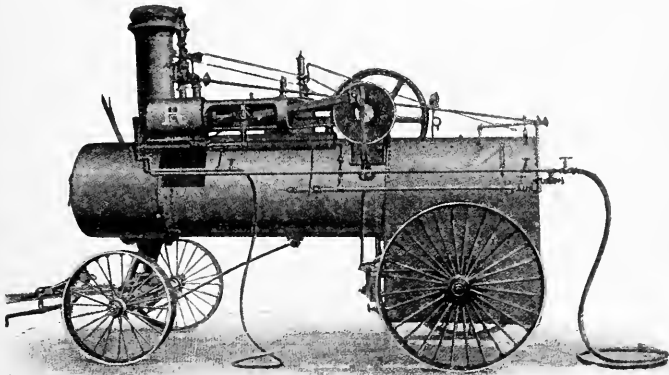

FIG. 316—SIDE-MOUNTED PORTABLE ENGINE

rear end of the boiler and is known as rear mounting. As a rule, the return tubular boilers are mounted on an axle which passes beneath the boiler. This style of mounting is given no special name, but might be called under-mounted boilers. There is now on the market a type of mounting which might be known as frame mounting; that is, there is a frame to which the drive wheels are attached, and it also supports the boiler.

**582. Side mounting.**—Fig. 316 shows the method of side mounting a portable engine. This is similar to a great many side-mounted traction engines. Fig. 317

shows a similar side-mounted traction engine. This is done by means of an axle for the drive wheel, which is

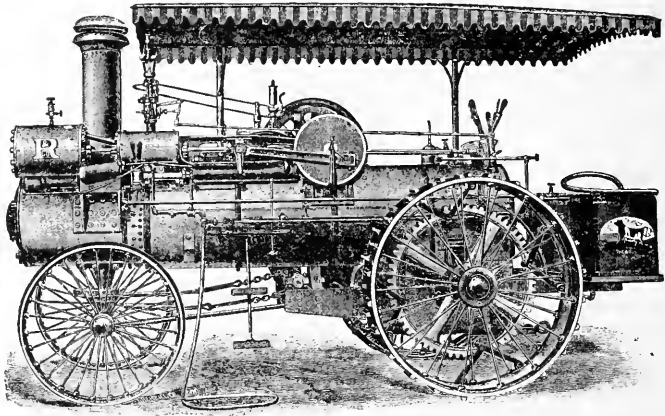

FIG. 317—SIDE-MOUNTED TRACTION ENGINE

substantially fixed to a casting. This casting, which is known as the bracket, is then riveted to the side of the fire box. Fig. 318 shows this principle very well excepting

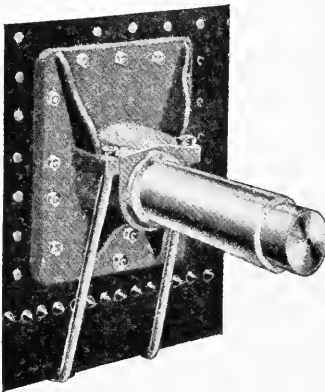

FIG. 318—BRACKET FOR SIDE-MOUNTED ENGINE

that the bracket is strengthened by means of a couple of rods which pass under the fire box and are correspondingly attached to the bracket on the other side. This is a very simple method, but has some disadvantages. The side bracket is attached only to the water leg of the boiler, while the total weight of the engine and boiler is thrown

upon it. It is obvious that this puts undue strain upon the boiler shell at a point where it is the weakest. The weight of the boiler and the engine is thrown upon these brackets and in such a manner that it has a tendency to throw the inside of the axle down and the outside up. This will tend to throw the tops of the drive wheels together and the bottoms apart. The weight is also thrown upon these axles so that that part of the hub of the fly-wheel next to the engine will wear faster than the middle, and as a result the wheels will tend to become wobbly in action and wear the teeth of the transmission gearing unevenly. A truss bar similar to that of Fig. 318 removes a great deal of the strain from the water leg, and

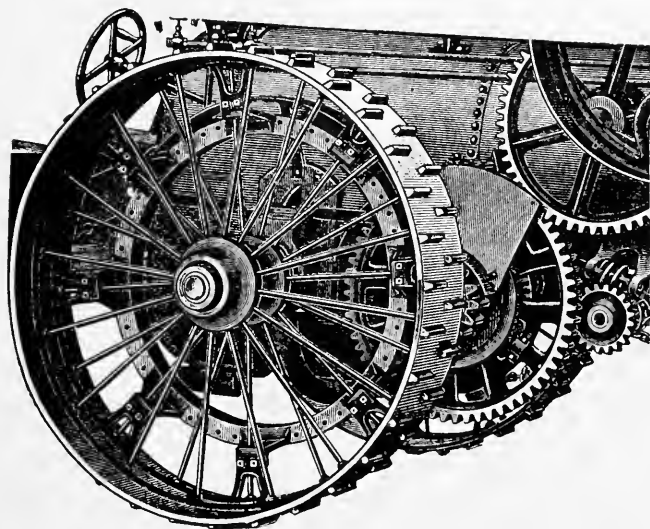

FIG. 319

also tends to hold the axles in line with each other, and thus keep the drive wheels more nearly vertical. Another method of side mounting an engine is shown in

Fig. 319. By inspection it will be noticed that this style of mounting is similar to that of Fig. 317, but in addition to this there is a heavy curved axle which passes from the bracket down beneath the fire box and up to the bracket on the opposite side. Although this style of mounting is considered superior to the one previously described, in order to prevent springing of the axle and the consequent wobbling of the wheels it will be necessary to make the axle too heavy for practice. Although

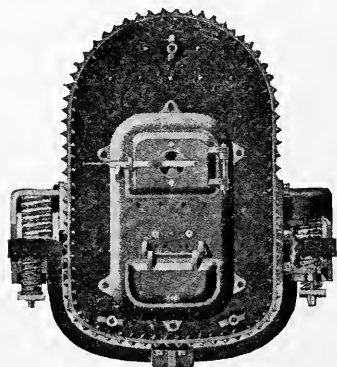

FIG. 320—SIDE-MOUNTED ENGINE WITH SPRINGS AND TRUSS BAR

the bad effects of the strain on the boiler are practically all removed by passing the axle beneath the fire box, the effect of the wearing of the boxings in the hubs is still uncared for. This allows the wheels to travel out of a vertical plane and wear the gearing irregularly. Fig. 320 shows an end view of this style of mounting, with the addition of springs. These springs are a benefit to a

traction engine in that they take the jar off the parts as the engine travels over rough roads or pavements.

**583. Rear mounting.**—Rear mounting, as a rule, is not as simply done as side mounting. However, it has some advantages over the other. Fig. 321 shows one type of rear mounting which has its merits. The brackets which support the boiler and the engines are attached to the corners of the water leg, thus removing the strain from a weak point to one which is stronger. By having the engine rear-mounted the axle upon which the drive wheels

travel is allowed to revolve in the bearings instead of the wheels revolving upon the axle. By having the axle revolve in this manner the wear is all in a straight line and on the top of the boxing, hence there is no reason for the wheels to become wobbly and cut the transmission gear-

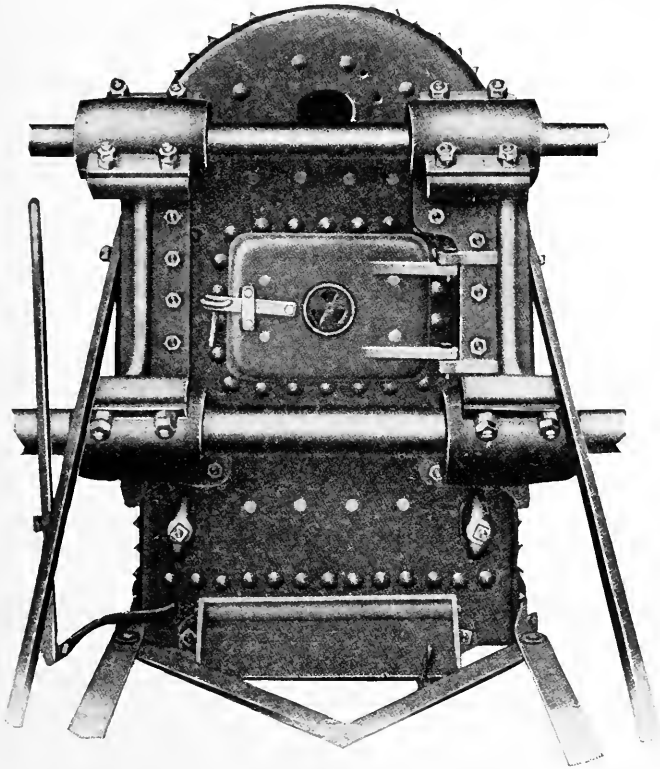

FIG. 321—REAR-MOUNTED ENGINE

ing unevenly. By referring to Fig. 322 it will be seen that the use of springs becomes impossible on a rear-mounted engine as shown in Fig. 321. Assuming that there are springs in this type of mounting, and that the

springs are so adjusted that when a jar comes upon the engine the teeth will mesh as shown in Fig. 322, then if there were no jar upon the engine and the springs were carrying it in its normal position, the gears *A* and *B* would not mesh, or else they would mesh just enough so that the teeth would catch and strip. If a spring could be placed so the combination of gears *A*, *B*, and *C* would

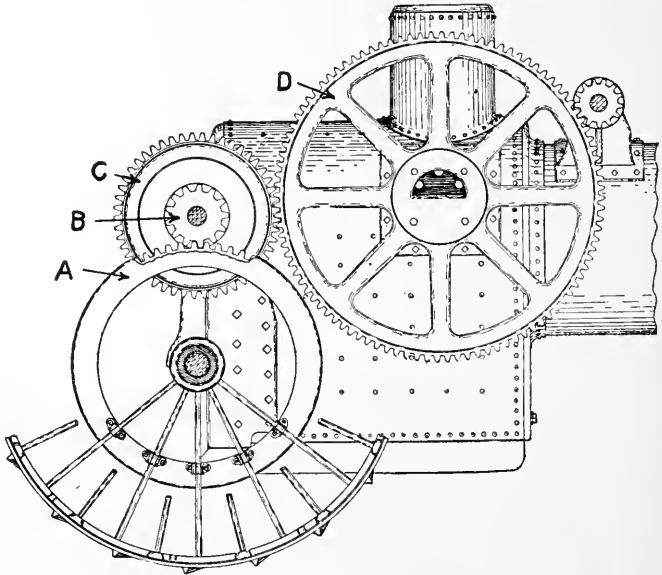

FIG. 322

rise and fall together in a circle whose radius is equal to the sum of the radii of the wheels *C* and *D*, it would be as effective and the wheels *C* and *B* would mesh. Fig. 323 shows the type of mounting which has this desired effect, but it has the additional complication of radius and cross links. As the springs respond to the jars of rough roads, these links keep the gear wheels the proper distance apart, so that they are always in proper mesh.



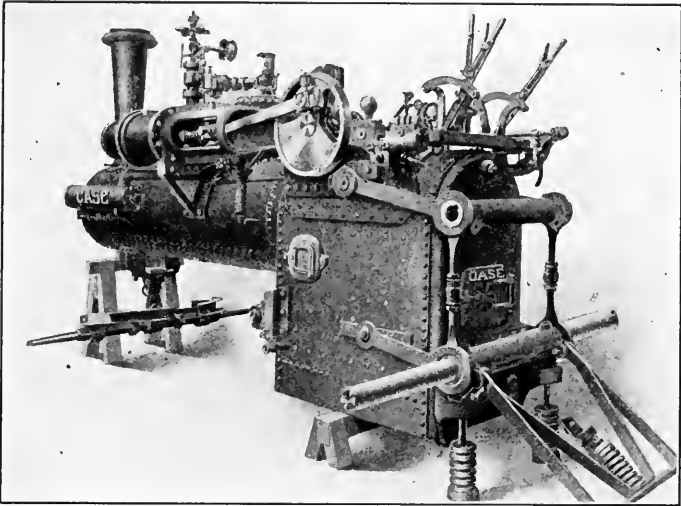

FIG. 323—REAR-MOUNTED ENGINE WITH RADIUS AND CROSS LINKS

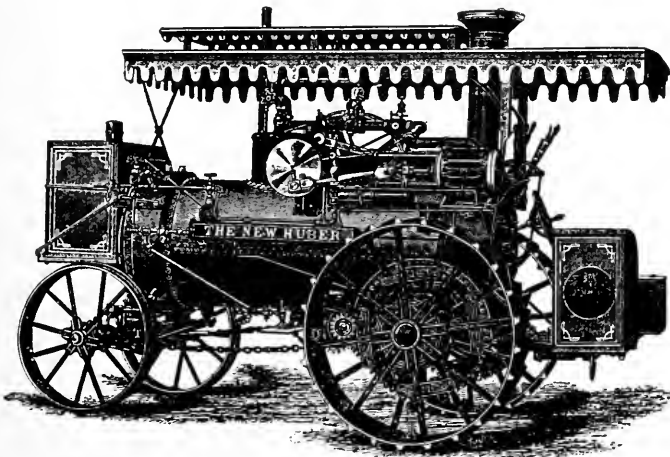

FIG. 324—UNDER-MOUNTED ENGINE

584. Under-mounted boilers.—Fig. 324 shows a type of mounting where the axle is straight and fastened directly beneath the boiler. By inspecting Fig. 325, this method of mounting will be more clearly understood. *A* is the

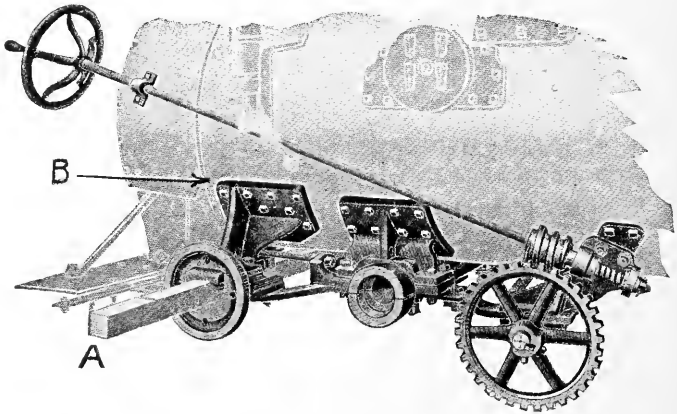

FIG. 325

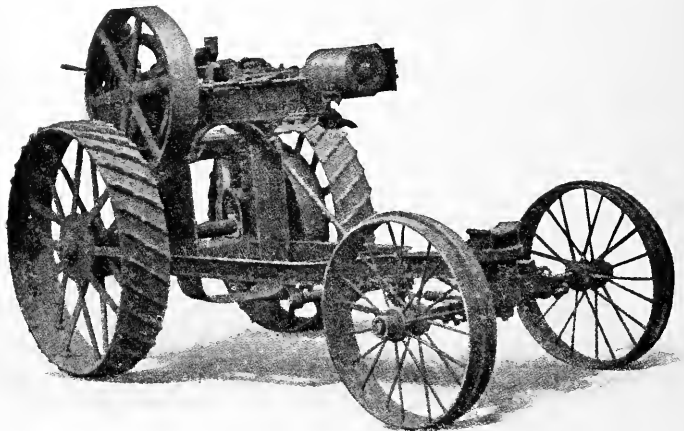

FIG. 326—FRAME-MOUNTED ENGINE

main axle upon which the drive wheels operate. Although made of a square bar, it is round at the bearing *B*, and revolves in it. Although the brackets for this type of mounting are attached to the boiler, the boiler itself, being round, is probably strong enough so that the excessive strain will cause very little trouble. This type of mounting very seldom contains springs.

585. **Frame mounting.**—To remove as much of the strain as possible from the boiler, some engines are now coming upon the market with a frame which supports engine, transmission gears, and boiler. Or else the frame supports the boiler and the boiler supports the engine.

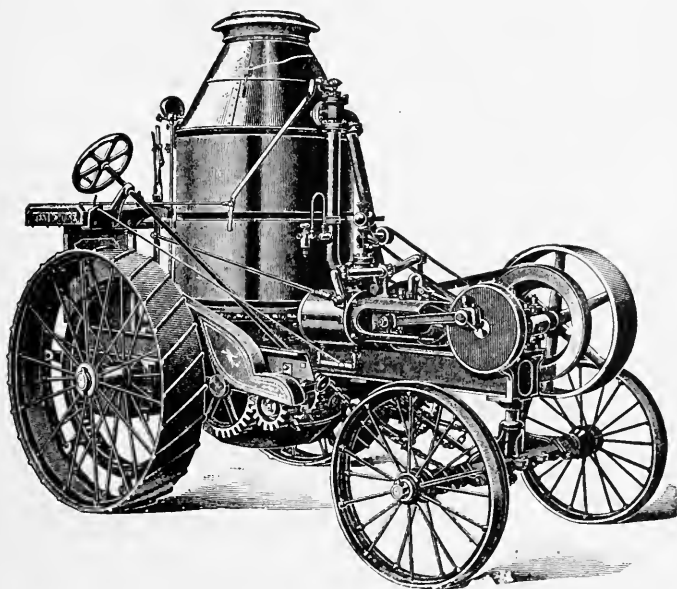

FIG. 327—FRAME-MOUNTED VERTICAL TRACTION ENGINE

Fig. 326 shows the frame for this type of engine with the boiler and transmission gears removed. Fig. 327 shows

a vertical traction engine and boiler complete. For a certain class of work there is a call for a style of frame mounting such as is seen in Figs. 328 and 329. In this style of mounting all the strain is thrown upon the frame, allowing the boilers to be freely suspended as shown.

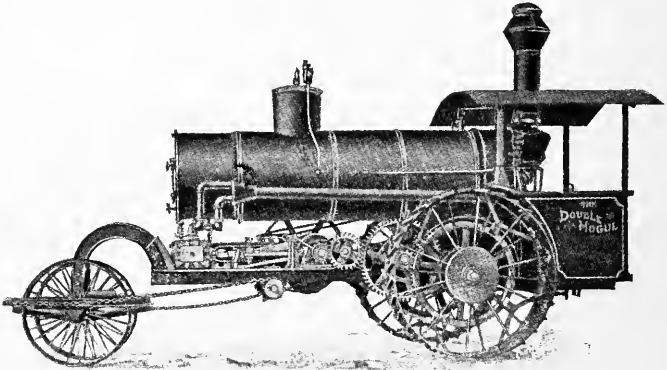

FIG. 328—FRAME-MOUNTED ENGINE OF THE LOCOMOTIVE TYPE

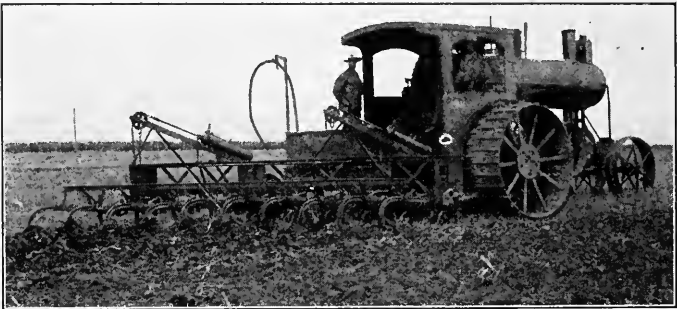

FIG. 329—LOCOMOTIVE TYPE OF TRACTION ENGINE WITH STEAM-OPERATED PLOW

586. Engine mounting.—Where the engine is not mounted upon the frame as shown in Figs. 326, 327, 328, and 329, it is mounted upon the boiler. This is not con-

sidered the best method. However, it is commendable for its simplicity and possibly counterbalances the evil effects of the extra strain upon the boiler. Fig. 330 illus-

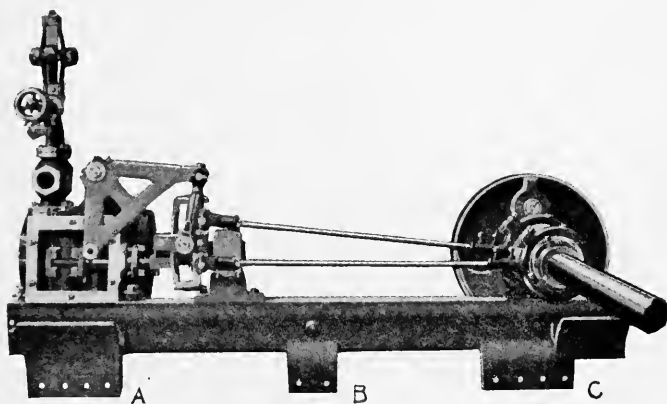

FIG. 330—ILLUSTRATING METHOD OF MOUNTING ENGINE ON BOILER

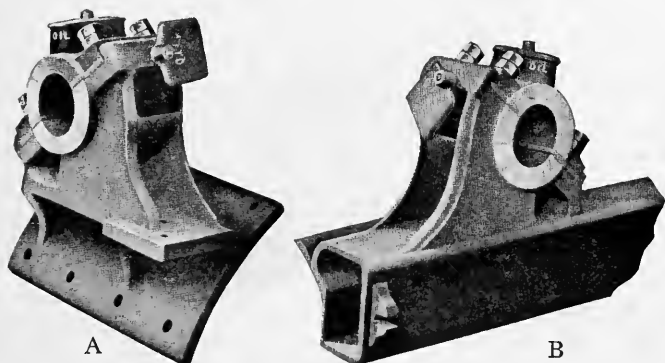

FIG. 331

trates the method which most engine builders utilize in attaching their engines to boilers. The brackets *A*, *B*, *C* are riveted directly to the boiler shell.

Fig. 331 shows the main bearing *A*, which is a part of the frame, also the bearing *B*, which is commonly known as the pillow block bearing. These bearings are both riveted to the boiler.

**587. Clutch.**—When the separator is being driven by the engine the traction part must not move. Consequently, there must be some method for throwing the power from the drive wheel which drives the pulley to the transmission gearing that runs the traction part of the engine. The device for transferring the power is a clutch generally located on the engine shaft. It acts upon the belt wheel of the engine. Fig. 332 shows a sim-

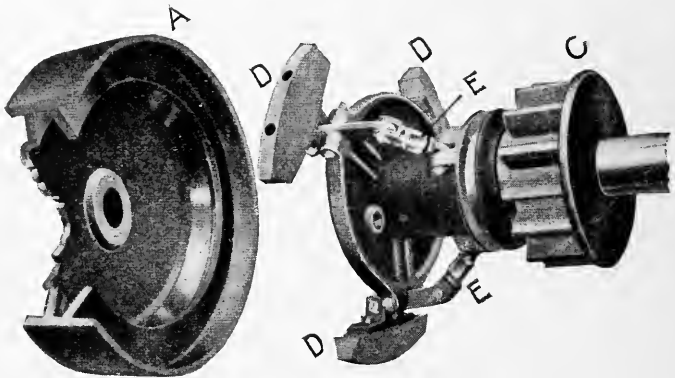

FIG. 332—CLUTCH

ple clutch in parts. *A* is the belt wheel upon which travels the belt that drives the separator. It is fixed to the engine shaft so that whenever the engine moves this wheel moves also. The clutch blocks and arms are seen at *D*, and the pinion is engaged with the transmission gearing at *C*. This part of the mechanism is not fixed to the shaft, and revolves with it only when the clutch is

locked. In other words, when the clutch locks, the blocks all are forced out against the rim of the belt wheel tight enough so they stick to it and the whole mechanism revolves with the wheel. The clutch is a very important part of the traction engine and requires very careful adjustment and care. Since the blocks *DDD* are continually wearing off, the arms *EE* have to be constantly adjusted. They should be so carefully adjusted that when thrown in, the clutch will lock and hold itself in position. They should also be adjusted so there will be no slip between the clutch blocks and the clutch shoe. Fig. 333

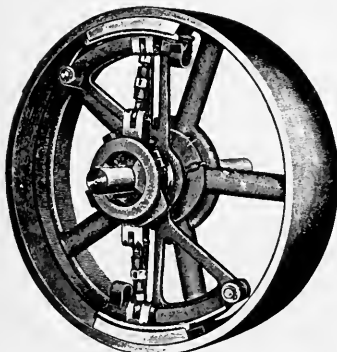

FIG. 333—CLUTCH WITH METAL BLOCKS

shows another type of clutch, which has a metal clutch block instead of wood.

**588. Transmission gearing.**—The steam engine for traction engine work generally has a speed of 200 to 225 revolutions a minute. If the drive wheels were connected directly to the engine shaft such a speed would drive the outfit over the ground nearly

as fast as a locomotive travels. This is something that could not be conceived of on country roads, hence the speed has to be reduced to one which is permissible. For this purpose a chain of gears such as is shown in Fig. 334 is utilized. Not only are these gears used to reduce the speed of rotation from that of the drive wheel to that of the engine, but since the engine is generally located some distance from the traction wheel shaft, these gears conduct the power from the engine shaft to the shaft of the

traction wheel. The intermediate gears are generally attached to the boiler by means of brackets as shown in Fig. 322. If the engine were always to travel straight ahead or straight backward the matter of transmission gearing would be very simple, but since it has to turn and often on a very small circle one wheel is compelled to travel faster than the other; consequently they cannot be both attached rigidly to the same shaft.

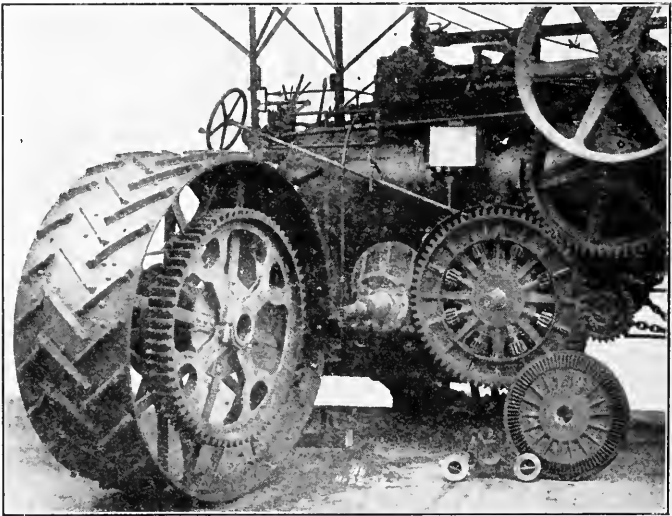

FIG. 334—GEARS CONNECTING ENGINE WITH TRACTION WHEELS

If one wheel were attached to the shaft and the other were allowed to go free then one wheel would do all of the traction work. This would not do, since the engine would have only half of the tractive power and for road work it is necessary that every pound possible of tractive pull be developed. To arrange the drive wheels of a traction engine so that both will pull when the engine is traveling in a straight line and also so they will travel



in a curve without slipping, a compensating gear is inserted in the chain of transmission.

**589. Compensating gears.**—Fig. 335 shows a simple, very effective compensating gear. The large pinion *A* carries the small pinions *CCC*. The shaft *F* is connected to the flywheel on the opposite side of the engine by means of a small pinion. The pinion *G* is connected to the other main gear. The power is transmitted from the engine shaft to the pinion *A*. As pinion *A* revolves in the direction of the arrow, pinions *CCC* will be driven, and they

in turn will propel the drive wheels. But if the drive wheel attached to pinion *G* happens to travel faster than that attached to shaft *F* the pinion *C* will revolve and still the pinion *A* will propel the gearing. Often there are some very severe jerks on the transmission gearing of an engine and some companies are now inserting in their compensating gears a

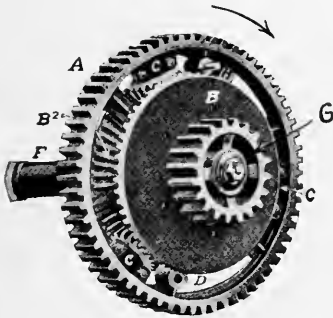

FIG. 335—COMPENSATING GEARS

set of springs which take this jar off the gearing.

**590. Traction.**—Any traction engine has power enough to propel itself over the road and through the fields provided the drive wheels do not slip. Consequently the matter of the wheels adhering to the ground is an important part. Where the road surface is firm there is no difficulty; but in a soft field great trouble is experienced due to the fact that the lugs of the drive wheels tear up the earth and allow the drive wheels to move without moving the engine. It is a common belief that the drive wheel which has the sharpest lug is the one which will

adhere to the ground the best. In nearly all cases this is not true, since the lug which is sharp is very apt to cut through the earth, while one which is dull or round and does not have such penetrating effect will pack the earth down and thus make more resistance for itself while passing through the earth. Nearly every engine builder has a style of lug of his own. Fig. 338 shows a new style of traction wheel which seems to be giving very good results. The more weight that can be put on to the drive wheels of an engine the better it will adhere to the ground, providing the surface is firm enough to support the load. This makes the matter of location of

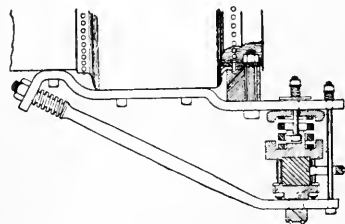

FIG. 336

the main axles upon the boiler an important factor. When the boiler is rear-mounted it is obvious that more of the weight is thrown upon the front wheels, which act as a guide, than when the boiler is side-mounted.

Hence one would be led to believe that the side-mounted traction engine will have better tractive power than the rear-mounted. It is also indicative of better tractive power when the pivot of the front axle is as far ahead as possible. For this reason some builders are now attaching a frame to the boiler and crowding the front trucks ahead. Fig. 336 is an illustration of this type of mounting.

**591. Width of tires.**—Where traction engines such as are used for harvesting and threshing grain simultaneously are used for plow work or in the field an exceptionally wide tire is required. If an engine is to be used for this work exclusively the wheels are made with the

proper width of tires at the factory. But where an engine is to be used for job threshing a part of the time and for plowing a part of the time the wheels should be made so an extra width of tire can be attached to support the engine for plowing.

**592. Road rollers.**—For road rolling purposes traction engines as a rule, especially the gearing and bearings, are made much heavier. The tires are wider, and the front truck instead of being made of two wheels is made into one broad wheel.

### HANDLING A TRACTION ENGINE

**593. Moving an engine.**—When moving an engine it is best to carry more water than when doing stationary work. This is especially true in hilly fields or hilly roads. The gauge glass and water cocks should be carefully watched. The steam pressure should be maintained near the blow-off point. Upon approaching a hill judgment should be exercised in regard to the fire and amount of water and pressure. As much water should be carried as is permissible without priming. If possible there should be sufficient fire when starting up a hill to carry the engine to the top. Judgment should also be exercised in regard to the speed. Taking an engine up a hill too fast is apt to cause priming. Also there is danger of reducing the steam pressure so that a stop will have to be made to raise it. When the summit of the hill has been reached, the fire can be started up, more water put in the boiler, and the engine allowed to travel faster. As much and probably more care should be exercised in descending a hill than in ascending. If possible the engine should be taken from the top of the hill to the foot without a stop. If this is not possible turn the engine around so that it sits as near level as possible while

the stop is being made. Every engineer knows the danger of having the front end of a fire box boiler the lowest. If the engine is inclined to run too fast in going down a hill the reverse should be thrown. If then it still travels too fast, while the engine is still in the reverse, open the throttle and let in a little steam.

**594. Guiding an engine.**—Traction engines are guided by means of the hand wheel, which operates through a worm gear. This in turn acts upon chains which are attached to the ends of the front axle. Turning the hand wheel to the right will turn the engine in that direction, while in turning the hand wheel to the left the engine will turn to the left. Do not turn the steering wheels too often or too far. Watch the front axle and act accordingly. It is much easier to steer an engine when moving than when standing. If possible always move the engine a trifle when steering. The steering chains should be moderately tight; if they are too tight they will cause undue friction, while if they are too loose the engine cannot be guided steadily.

**595. Mud holes.**—The best way to get out of a mud hole is not to get into it. An engineer should go out of his way a considerable distance rather than to take his engine into a mud hole. When an engine is once in a mud hole and the drive wheels commence to slip without propelling, the engine should be shut down at once. When the drive wheels are run in the mud without moving the engine they soon dig up a hole out of which it is very hard to raise the engine. When drive wheels commence to slip, straw, boards, rails, posts, or anything at hand should be put under them so they may get a grip. In getting out of a mud hole do not start the engine quickly, but very slowly. If the wheels will stick at all they will gradually move the engine by starting it

slowly, while if starting it quickly the grip of the wheels gives away before momentum can be put into the engine. If stuck in a mud hole always uncouple the separator or whatever load the engine is hauling, move the engine out, then by means of a rope or chain pull the separator across. If the engine is stuck in a soft place like a plowed field often the hitching of a team in front will take it out.

**596. Bridges.**—Before crossing a bridge or culvert the engineer should make inspection to see if it will carry the weight of his engine and the separator. If there be any doubt and it is impossible to move the engine around the bridge heavy planks should be placed across it to distribute the load. Always move slowly while crossing a bridge. If the engine has once broken through it can sometimes be removed by winding a rope around the belt wheel several times, then setting the friction clutch and hitching a team upon the rope. As the rope gradually unwinds, it will move the engine by means of the transmission gearing.

**597. Gutters.**—In road work often one drive wheel of an engine will strike a soft place in the gutter. Owing to the principle of the compensating gear this wheel will then slip in the mud and revolve while the other wheel will remain stationary and the engine not move. In a case like this the compensating gear should be locked and both wheels be made to revolve together. The wheel which is on the solid ground will move the engine out of the hole. To lock the compensating gear there is generally some scheme, as in Fig. 335, whereby a pin can be inserted in the pinion *A* and lock the pinion *D* by means of the projection *H*.

**598. Reversing the engine on the road.**—When it is desired to reverse a traction engine moving on the road

the throttle valve should be closed, the engine reversed, then the throttle opened. Traction engines are usually made strong enough so they will stand the strain of being reversed without closing the throttle. This, however, is hard on the bearings, and the engineer should always close the throttle before reversing the engine, especially if the engine is running at full speed.

**599. Setting an engine.**—A new engineer will experience some difficulty in setting an engine so it is properly lined with the separator. On a still day the belt wheel of the engine should be in line with the separator. This is also true when the wind is blowing in line with the engine and the separator. But if the wind is at an angle allowance will have to be made for the amount which it will carry the belt to one side. Often the engine will have to be set a few feet out of line with the separator and toward the wind. If the engine has been set when there is no wind and enough wind comes up to throw the belt over, it is not necessary to stop the engine and move, but a jack screw can be set against the end of the front axle and the engine worked over toward the wind. Also the front end of the separator should be crowded in a similar manner until the belt runs in the proper position on the pulley. The friction clutch should always be used in backing the engine into the belt.

**600. Gasoline traction engines.**—Since the gasoline traction engine requires no boiler, the engine with its necessary accessories, such as water tanks, gasoline tanks and battery boxes, is mounted upon a frame. Consequently the mounting of a gasoline engine is more simple than that of a steam engine. However, it has a disadvantage which the steam engine does not have; that is, the engine itself cannot have its direction of rotation reversed without a great deal of trouble, consequently

there has to be connected into the transmission gear a reversing gear. The simplest of the reversing gears for gasoline engines now on the market is a system of friction pulleys, such that when the engine is in one position on the frame the traction wheels will move forward. When it is in another position another set of wheels is connected in and the traction wheels will move backward. It will be noticed from this that the engine, which generally weighs 2,000 or 3,000 pounds, has to be slid backward or forward on the mounting frame. Fig. 337 shows a type of engine which reverses as above

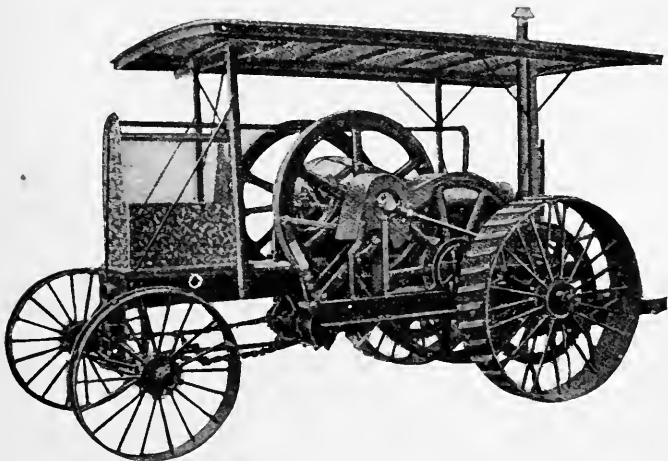

FIG. 337—GASOLINE TRACTION ENGINE WITH FRICTION GEARING

described. This engine is operated by means of a set of friction wheels, instead of a set of gearing as steam traction engines are run. Fig. 338 illustrates an engine which utilizes pinions for its transmission gearing similar to a steam traction engine.

*Rating.*—Gasoline traction engines are all rated upon

the horse power they will develop at the brake. Consequently when one speaks of a 15 H.P. gasoline engine he refers to an engine which will develop only about the same horse power which a commercially rated 7 H.P. steam engine will develop. For this reason when comparing the powers of the two engines it is always well at least to double the size of the gasoline engine to do the work which a commercially rated steam traction engine has been doing.

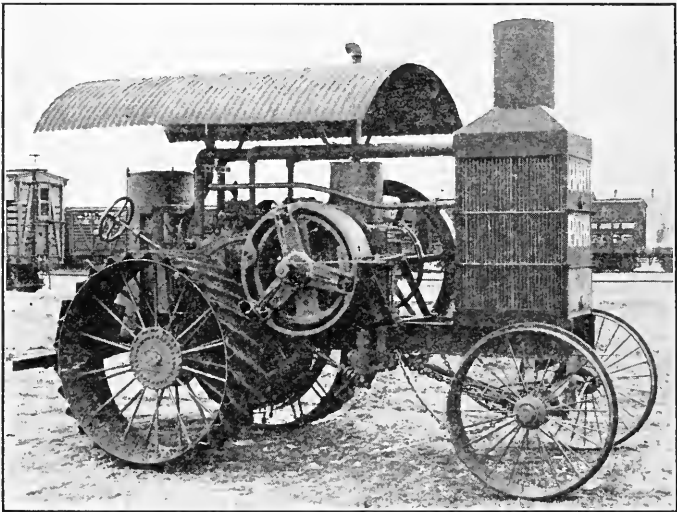

FIG. 338—TRACTION ENGINE WHICH REVERSES IN THE CLUTCH

*Regulation of speed.*—A gasoline traction engine operated by means of friction gearing, as illustrated in Fig. 337, can have any speed required of it at the expense of slippage between the gears. But a positively driven traction engine must have other methods of changing the speed. These methods generally amount to changing



the point of ignition in the engine in order to reduce the power at low speed, or else shifting the power from one set of gears to another. Generally in an engine where the power is shifted there are only two speeds, a high and a low.

*On the road.*—About the same caution should be exercised in handling a gasoline traction engine through soft and muddy places and over bridges as in handling a steam engine. But there is practically no caution to be taken in climbing hills other than that taken on level ground. Upon descending a hill a strong and effective brake should always be at the control of the operator.

*Traction.*—As a rule gasoline traction engines are much lighter than steam traction engines. Consequently their tractive power is correspondingly less. And for heavy traction work the size of the engine must be increased in order to add to the tractive power.

## CHAPTER XXII

### ELECTRICAL MACHINERY

601. **Natural magnets.**—The name magnet was given by the ancients to a brown-colored stone which had the property of attracting certain metals. Later the Chinese found that when free to move this stone always pointed in one direction, and they named it loadstone (meaning to lead). The commercial name for it is magnetite ( $\text{Fe}_3\text{O}_4$ ). This mineral is found in such quantities in several localities that it is a valuable ore for producing iron.

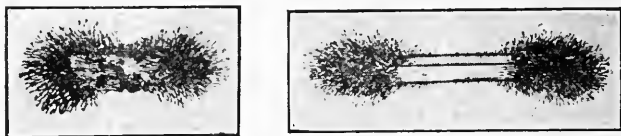

FIG. 339—NATURAL AND ARTIFICIAL MAGNETS ATTRACTING IRON FILINGS

602. **Artificial magnets.** — The ancients learned by stroking pieces of steel with natural magnets that the steel would become magnetized. Magnets produced in this manner are known as artificial. They are now made by stroking bars of steel with another magnet or an electromagnet, which will be described later.

603. **Poles.**—If a magnet is sprinkled with tacks or iron filings, it will be noticed that the filings attach themselves to the ends of the magnet but not to the middle of it. The name poles has been given to these places where the filings adhere. A suspended magnet will swing so that one of its poles points toward the north. This pole is then known as the + or north-seeking pole, or simply the north pole (N), and the other end is known as the —

or south pole (S). The mariners' and the engineers' compasses work upon the same principle.

**604. Magnetic lines of force.**—Again, if a sheet of paper be placed over a magnet and some filings then dropped upon the paper, and if the paper is slightly jarred, the filings will assume the position shown in

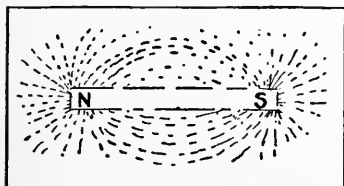

FIG. 340

Fig. 340. From this it is gathered that the magnet has lines of force and that these lines are of the form indicated in Fig. 341. For convenience it is assumed that the lines of force leave the magnet at the N pole and enter at the S pole.

**605. Laws of magnets.**—If the north and the south poles of two magnets are determined and marked it will be noticed that when one of the magnets is suspended so it is free to move in any direction and the north pole of the other is brought close to the south pole of the suspended one, these two ends attract each other. If, on the other hand, the N ends be brought together it will be

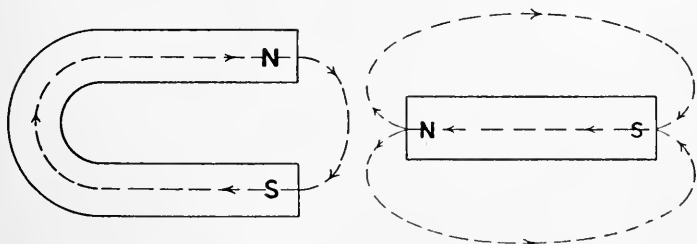

FIG. 341—DIRECTIONS OF LINES OF FORCE

noticed that they repel. Hence the general law of magnets is deduced: **Like poles repel and unlike poles attract.**

The force of this attraction is found to vary inversely as the square of the distance, i.e., increasing the distance

between the poles two times reduces the force acting between them  $2 \times 2 = 4$  times. In other words, the force is one-fourth as strong.

**606. Magnetic materials.**—Steel and iron are the only common substances which show magnetic properties to any appreciable degree.

### STATIC ELECTRICITY

**607. Static electricity.**—If a hard rubber rod be rubbed with flannel and then brought close to a suspended pith ball the ball will jump toward the rod. By rubbing the rod has been electrified and the action of the charge is to attract the ball. This charge of electricity is not within the rod but is on the surface and is known as stationary or static electricity. Another example of this is rubbing a glass rod with silk.

**608. Laws of electrical attraction and repulsion.**—If a rubber and a glass rod be excited and suspended as shown

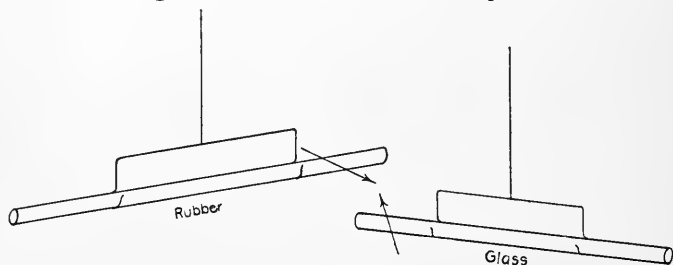

FIG. 342

in Fig. 342 and brought close together it will be noticed that they attract each other, but if two rubber rods be suspended in the same way and brought together, they will repel each other. Hence the following law is advanced: **Electrical charges of a like kind repel each other and those of an unlike kind attract.**

**609. Density of charge varies with form of surface.**—

Since all of the little particles of a charged substance, because of their mutual repulsion, tend to get as far away from each other as possible, the density of a charge is very much greater on the ends of an oblong body than in the middle. If the ends be drawn to a point the charge will become so intense that the point cannot hold it all and some of it will be given off to the air.

**610. Lightning and lightning rod.**—In 1752 Franklin with his famous kite and key learned that there is electricity in the clouds. He also showed that lightning is only a huge electric spark and that by means of points like lightning rods these mammoth sparks may be dissipated into the earth. As the cloud which is charged with electricity approaches it induces an opposite charge in the points and the charge is then quietly conducted away, while if the points are not there the electric charge will

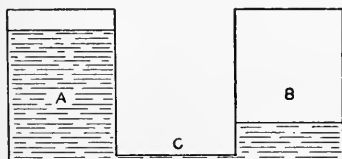

FIG. 343

assume such a volume that when the cloud does give it up it will strike the building in such a great bolt that damage is done. From this it will be seen that lightning rods do not protect the building by conducting the whole charge of the stroke away at once, but by diffusing and thus preventing the charge collecting in large quantities.

**611. Potential difference (P.D.).**—If water is placed in a tank *A*, Fig. 343, it will run through the pipe *C* into tank *B*. We attribute the running of the water from tank *A* to tank *B* to the difference in pressure between the two tanks. In exactly the same way will a positive charge of electricity flow from one body to another. Thus, just as water tends to flow from higher pressure to lower, does electricity of a higher potential flow to a

lower. Moreover, if the tank *A* is not continuously supplied with water the tank *B* will soon be filled to an equal level; likewise if current is not supplied to the body having the greater potential, the potential will become the same in the two bodies.

**612. Volt or unit of potential difference.**—To measure the amount of work required to transfer a charge from one body of a high potential to one of a low potential there must be a unit. This unit is called the **volt** in honor of the great physicist Volta. It is roughly equal to the P.D. between one of Volta's cells and the earth.

### CURRENT OR GALVANIC ELECTRICITY

**613. Current electricity.**—Electricity is an invisible agent and is detected only by its effects or manifestations. Current electricity is generally detected by its magnetic effects. That is, near all currents of electricity there are indications of magnetism, while in stationary or static electricity there are none.

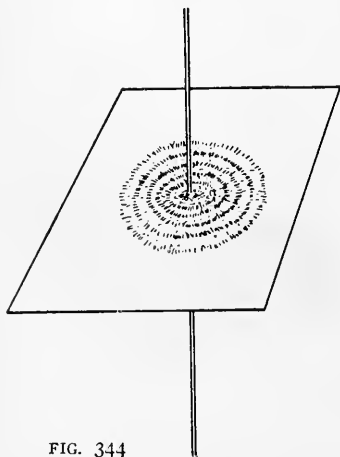

FIG. 344

**614. Shape of magnetic field about a current.**—If a wire carrying a heavy current of electricity be run through a cardboard and filings be sprinkled upon the board they will form themselves into concentric rings about the wire (Fig. 344). A compass placed in this field and at several positions will show that the lines of force are all in one direction. Reverse the current and the needle will also reverse. This

shows that there is a direct relation between the direction of the current in the wire and the direction of the magnetic lines which encircle it.

**615. Right-hand rule.**—Ampère devised a rule in which the right hand is used as a means to indicate this relation in all cases. Let the right hand grasp the wire (Fig. 345) so that the thumb points in the direction in which the current is flowing and the fingers will then point in the direction of the magnetic lines of force. Ampère being the investigator who made quantitative measurements of current electricity, the unit of measurement was named **ampere** in his honor. Owing to the peculiarity of electricity

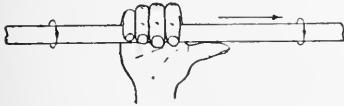

FIG. 345

it cannot be measured in pints and gills as liquids but can be measured by the chemical effect it will produce, i.e., one ampere will

deposit in one second 0.0003286 gram of copper in a copper voltmeter.

**616. The ammeter** is an instrument used for the measuring of amperes. Commercial ammeters do not



FIG. 346—AMMETER

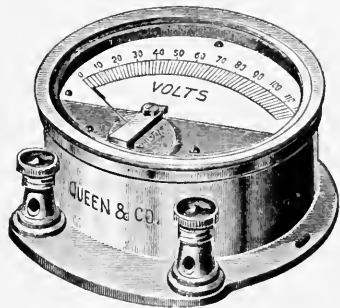

FIG. 347—VOLTMETER

measure them by means of chemical deposits, but by means of a needle enclosed in an electrical coil in such a

manner that as the current varies the magnetic force of the coil will vary, and cause a deflection of the needle.

**617. Voltmeter.**—To measure the electrical pressure or potential difference requires an instrument similar to the ammeter excepting that instead of having a few coils of wire it often has several thousand coils of very fine wire. Only a very small amount of current will pass through these numerous coils.

*Electromotive force.*—The total electrical pressure which an electrical generator is able to exert is called its electromotive force, commonly abbreviated to E.M.F.

**618. Electrical power.**—The unit of electrical power is a unit of electrical work performed in a unit of time and is called a **watt**.

The product of volts into amperes gives watts, i.e., volts  $\times$  amperes = watts.

**Example.**—An incandescent lamp is fed by a current having a voltage of 220 and requires 0.3 ampere of current. The electrical power consumed is then

$$\begin{aligned} V \times A &= W, \\ 220 \times 0.3 &= 66.0 \text{ watts.} \end{aligned}$$

*Kilowatt.*—The watt is such a small quantity that it has become the custom to use a larger unit known as the kilowatt.

or,

$$\begin{aligned} 1 \text{ kilowatt} &= 1,000 \text{ watts,} \\ 1 \text{ watt} &= 1/1,000 \text{ kilowatt.} \end{aligned}$$

*Horse power.*—By experiment it has been found that .7375 foot pound per second = 1 watt.

Now, since 550 foot pounds a second is the equivalent of one mechanical horse power, an equivalent rate of electrical working would be :

$$\frac{550}{.7375} = 746 \text{ watts} = \text{one electrical horse power.}$$

**619. Resistance.**—If two pipes of the same diameter but different lengths lead from a tank of water, the water



will flow very much faster from the short pipe than from the long one. From this we learn that the pressure decreases as the water passes through the pipes and the longer the pipe the more it falls. The friction between the water and the inside of the pipe retards the flow and is known as resistance. Electricity flowing over a wire is an analogous case. The current meets with resistance in the wire and there is a fall in potential.

*Comparative resistance.*—To measure comparative resistance, silver is the unit of comparison, it having the lowest resistance of any substance.

Specific resistance of some metals:

Silver, 1.00;

Copper, 1.13;

Aluminum, 2.00;

Soft iron, 7.40;

Hard steel, 21.00;

Mercury, 62.70.

*Laws of resistance.*—As the lengths of wire increase the resistance increases and as the diameter increases the resistance decreases. Hence the following law is deduced: That the resistance of conductors of the same materials varies in direct proportion to length and inversely to the area of the cross-sections.

The resistance of iron increases with rising temperature, likewise with nearly all metals, while the resistance of carbon and liquids decreases as the temperature increases.

*Unit of resistance.*—A conductor maintaining a P. D. of one volt between its terminals and carrying a current of one ampere is said to have a resistance of one ohm. The **ohm** is the unit of resistance and is named in honor of George Ohm, the great German physicist.

*Ohm's law.*—The current existing in a circuit is always

directly proportional to the E.M.F. in the circuit and inversely proportional to the resistance.

Hence if

$C =$  current,

$E =$  E.M.F.,

$R =$  resistance,

$$C = \frac{E}{R}, \text{ or current} = \frac{\text{E.M.F.}}{\text{Resistance}}$$

Likewise,

$$\text{Amperes} = \frac{\text{Volts}}{\text{Ohms}}$$

**620. Rheostats.**—The common method for controlling the current required for various electrical purposes is either to insert or to remove resistance. By Ohm's law

$$C = \frac{E}{R} \quad (\text{A})$$

If  $E$  is kept constant and  $R$  is varied,  $C$  will also be varied but with an inverse ratio. Any instrument which will change the resistance in a circuit without breaking it is known as a **rheostat**. A rheostat can be constructed

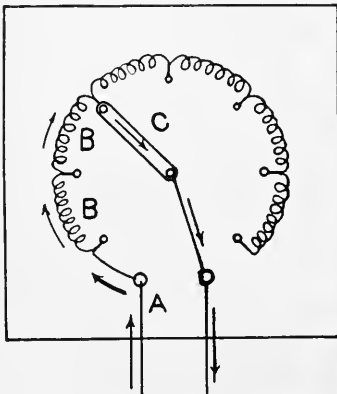

FIG. 348—PRINCIPLE OF RHEOSTAT

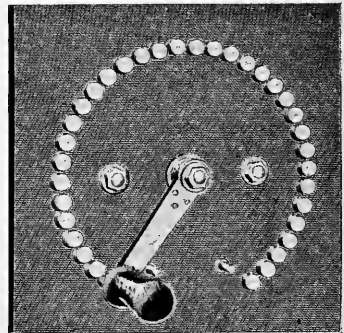

FIG. 349—COMMERCIAL RHEOSTAT

of various substances: coils of iron wire, iron plates or strips, carbon, columns of liquids, etc. Fig. 348 illustrates a commercial rheostat. The current enters at  $A$ ,

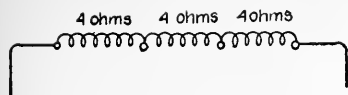

FIG. 350—SERIES CONNECTIONS

through the arm *C* and pivot *D*. The rheostat absorbs energy and throws it off as heat instead of doing useful work with it.

**621. Series connections.**—When lines are connected up as in Fig. 350, so that the same current flows through each one of them in succession, they are said to be connected in series. In this case the total resistance is the sum of the several resistances.

$$4 + 4 + 4 = 12.$$

**622. Parallel connection.**—If instead of connecting these lines up as in Fig. 350 they be connected as in Fig. 351 they will be in parallel and the total resistance will be only one-third of the resistance of one of them. This is obvious, for in this connection there is three times as much cross-section of wire carrying the current as in the previous case, and by formula (A) the resistance varies inversely with the sectional area.

**623. Shunts.**—One line connected in parallel with another is said to be a shunt connection to the other. In Fig. 351A, *S* is shunted across the resistance *R*. If *R* has a greater resistance than *S* it will carry less of the current, since the currents carried are inversely proportional to the resistance. Hence if *R* has a resistance of 5 ohms and *S* a resistance of 1 ohm, *R* will carry one-fifth as much current as *S* or one-sixth of the total current.

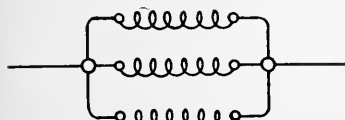

FIG. 351—PARALLEL CONNECTIONS

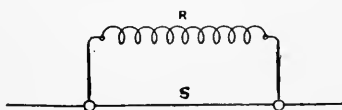

FIG. 351A—SHUNT

passes through the resistance *B*, which can be increased or decreased as the metallic arm *C* is moved from point to point, and out

**624. Cells.**—If a strip of copper be connected to one end of a strip of zinc and the free ends of the two metals be immersed in dilute sulphuric acid (Fig. 352) a current of electricity will manifest itself in the wire. If the circuit is broken and the plates carefully watched, bubbles will be seen to collect on the zinc plate and none on the copper. As soon, however, as the circuit is completed again a current will be noticed, also a great number of bubbles will appear about the copper plate. These last bubbles are bubbles of hydrogen and always appear when a current is being produced. The bubbles which form about the zinc are also of hydrogen, but they are caused by the zinc being impure and by a current starting up between these particles of impurities and the particles of zinc. This action is detrimental to the cell and should be stopped by covering the zinc with mercury.

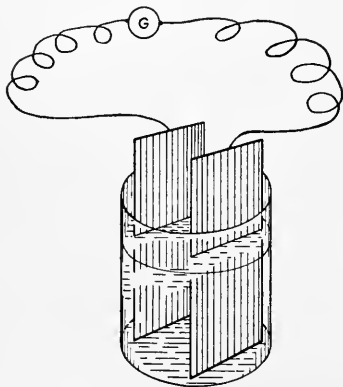

FIG. 352—CELL

In other words, the copper plate is the positive terminal and the zinc is the negative.

**625. Polarization.**—After the current has run for some time in the cell as previously described the strength will

By permitting the current of this cell to run for some time it will be noticed that the zinc is being gradually eaten away, and that the copper plate does not change. From this it is learned that when the current of a simple cell is formed the zinc is eaten away and hydrogen collects on the copper. The current passes out from the copper plate and in on the

become very much weaker, but if the copper plate be removed and wiped, then reinserted, the current will be as strong as ever. From this it is learned that the hydrogen bubbles collect on the copper and form an insulator, so that the chemical action is retarded. This forming of hydrogen bubbles is known as **polarization**, and in a good cell there must be some means to check it.

The various forms of cells now in use differ from the above only by using different electrodes and having some method for checking polarization.\*

**626. Dry cells.**—Dry cells differ from liquid cells only in that the exciting fluid is formed into a jelly or held in suspension by some absorbent such as sawdust or pith.

In the common commercial type the zinc element is in the form of a cylinder and holds the exciting fluid and carbon. The ends of the cylinder are generally sealed with wax. The following proportions by weight will make a very good cell: 1 part zinc oxide; 1 part sal ammoniac; 3 parts plaster; 1 part zinc chloride; 2 parts water.

**627. Heating effect of an electric current.**—Owing to the resistance to an electric current passing through a conductor, heat is developed. If the current is small and the cross-section of the conductor large the amount of heat developed will hardly be noticeable, but if the current is strong and the conductor small in cross-section, the latter will soon become hot, often red hot, and sometimes melt down. It is due to this heating effect that many machines are burned out, and it is also due to this same effect that more machines are saved.

**628. Fuse.**—If a piece of copper wire is connected in series with one of lead and a current sent through them the lead will melt down at a little over 600° F., but it

\*For discussion of commercial cells see any text book on physics or elementary electricity.

will require a temperature of nearly 2,000° to melt the copper.

Because lead melts at such a low temperature it is used as a fuse. A fuse consists of a leaden wire connected in series with the circuit it is to protect, and when the current becomes too excessive the lead melts out and thus opens the circuit. Fuse wires, as they are called, are always labeled with the number of amperes they are supposed to carry.

**629. Magnetic properties of coils.**—Let a wire carrying a current be formed into a small single coil and bring a compass close to it. When the compass is on one side of the coil it will be noticed that the N pole is attracted and the S pole repelled. Change the compass to the other side and the reverse will be found true. Now reverse the direction of the current and it will be found that the needle acts in just the opposite manner. From this it is learned that the electric coil is simply a flat disk magnet with a N and a S pole, the same as any other magnet.

**630. Electromagnet.**—When instead of forming the wire which carries the current into a single loop the wire is formed into several loops in the shape of a helix, a compass brought into its field will produce the same actions of the needle as in the single loop, only they will be much more violent. Now, if a soft iron bar, commonly known as a core, be placed within the helix, a very strong magnet known as an electromagnet will be formed. The lines of force of such a magnet are identical with those of the bar magnet. Hence, if the electromagnet is constructed so that the lines of force can remain in iron throughout their entire length, the magnet will be much stronger. For this reason electromagnets are made in the horseshoe form as shown by Fig. 353.

**631. Electric bell.**—The electric bell is a simple application of the electromagnet. The current enters at *A* (Fig. 354), passes through the horseshoe magnet *B*, over the closed circuit breaker *C*, and out at *D*. The instant the circuit is completed through the coils a magnet is formed, which attracts the armature *E*, and rings the gong *F*. But as soon as the armature is drawn down

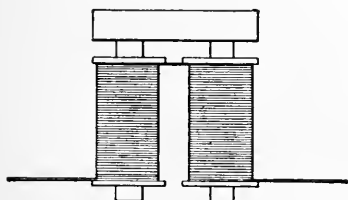

FIG. 353—ELECTROMAGNET

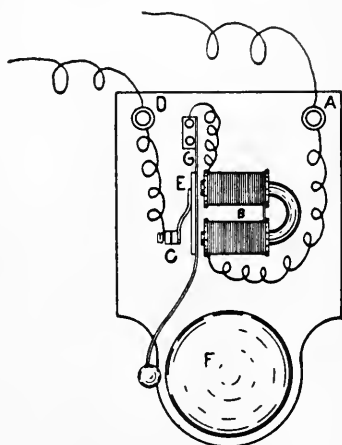

FIG. 354—ELECTRIC BELL

against the poles of the magnet the circuit is broken at *C*, hence the current stops flowing and the magnet becomes nil. As soon as the magnet has no strength the force of the spring *G* draws the armature back and makes contact at *C* again, and the operation is repeated.

**632. Electromagnetic induction.**—In a previous paragraph it has been shown that there is a magnetic field surrounding all electric currents. If a wire be arranged so as to form a closed circuit and then moved across a magnetic field a reverse action of that explained above will take place. In other words, if a closed circuit be moved

through a magnetic field a current will be set up. This is the most important part of electricity, for upon it is based the operation of nearly all forms of commercial electrical machinery.

**633. Currents induced in a coil by a magnet.**—A sensitive galvanometer is connected in a circuit with a wire (Fig. 355) in such a manner that the galvanometer is not affected by the magnet and yet the wire can come into the magnetic field. If that part of the wire between *A* and *B* be very quickly moved down across the field the galvanometer needle will be deflected. When the needle comes to zero and the wire is moved across the field in the opposite direction the needle is again deflected, but the opposite way. If the wire be moved into the magnetic field and held still the needle will come to zero and remain there until the wire is set in motion. Again, if the wire is moved back and forth across the magnetic field the needle will vibrate back and forth across zero, showing that there is a current but an alternating one.

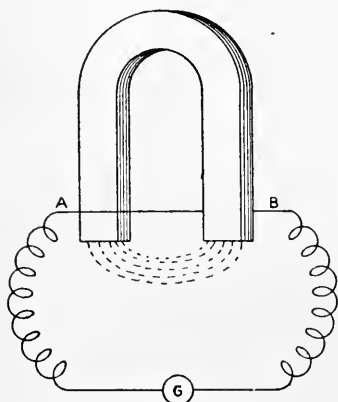

FIG. 355

When the backward and forward motions of the wire have become fast enough the needle of the galvanometer will practically stand at zero, only giving enough vibration to show that there is an alternating current affecting it. By trial the following results will be obtained:

1. When the magnet is moved and the wire held stationary the same results are noted.

2. When the position of



the poles of the magnet is reversed the current is also reversed.

3. When an electromagnet is used in place of the permanent one the same results are noticed.

4. The induced current is produced by the expenditure of muscular energy and does not weaken the magnet.

5. When the wire is moved so as to cut the magnetic lines of force at right angles the momentarily induced current is greatest.

6. The direction of the lines of force is at right angles to the direction of the current in the wire.

**634. Factors upon which the value of induced E.M.F. depends.**—If the wire in Fig. 355 be very quickly moved across the magnetic lines of force the galvanometer needle will deflect farther than when the wire is moved slowly. Also, if two magnets with their similar poles together are used instead of one and the wire is moved at the same velocity as previously the needle will have a greater deflection. Again, if a coil of wire be used instead of a single one the deflection of the needle will be greater. Hence it is obvious that the induced E.M.F. is dependent upon and proportional to the number of magnetic lines cut, the speed or rate at which they are cut and the number of wires cutting them.

**635. Currents induced in rotating coils.**—Instead of cutting the magnetic lines of force of a strong magnet with a single wire let them be cut with a coil of 400 or 500 turns. Let the coil be small enough so it will rotate between the poles of a horseshoe magnet. With the coil at right angles to the plane of the poles rotate it  $180^\circ$  and note the direction of deflection of the galvanometer needle. Rotate the coil the other  $180^\circ$  and bring it to the position from which it started and again note the direction of the deflection of the galvanometer needle.

The needle shows that a current has been induced which has two directions of flow during each revolution of the coil. This induced current is produced in exactly the same manner in which currents are produced by dynamos.

**636. Dynamos** are machines for converting mechanical into electrical energy. They cannot develop energy but simply change the form of the energy delivered to them. Since they cannot develop energy, the amount of current delivered by them is wholly dependent upon the amount of mechanical energy supplied. In principle the dynamo consists of two parts: a magnetic field made up of

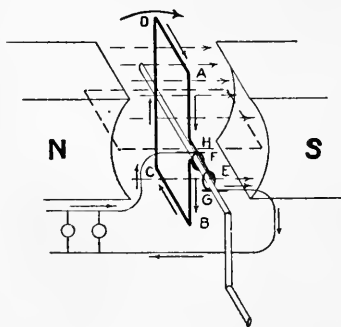

FIG. 356

electromagnets and a number of coils of wire wound upon an iron core forming an armature.

**637. Simple alternating-current dynamo.**—Consider the single loop of wire *ABCD* (Fig. 356) as the armature and the poles *N* and *S* as the magnets of a dynamo. With the armature in the position it is shown there is no current developed. The armature is for the instant moving parallel to the magnetic lines of force and consequently is cutting none of them. As the armature moves from a position perpendicular to the lines of force to a position parallel to them, the number of lines it cuts increases until it reaches the perpendicular position, and from then on until it has traversed  $180^\circ$  the number of lines cut decreases until none are cut. From this it is obvious that with the armature in the first and last positions no cur-

rent is produced and when the armature is cutting the greatest number of lines of force the current is at a maximum. When the armature is turned through the remaining  $180^\circ$  of the revolution the same action takes place. As the side  $AD$  moves down the current flows in the direction indicated, but as the side  $BC$  moves down it is reversed. Hence for one half of the revolution the current flows in one direction and for the other half it flows in the opposite direction. One end of the coil is attached to the metal ring  $E$ , and the other end is attached to the ring  $F$ . Both rings are fixed to the shaft, so they rotate with it.

*Brushes C and H* are in continual contact with the rings, so the current is taken from them and carried over the circuit.

*Armature.*—It might be assumed that the iron part of an armature of a dynamo is only to carry the numerous wires which are used for cutting the magnetic lines of force, but this is not the only use for the iron core. The iron carries the magnetic lines of force very much better than they travel through air, and for this reason the

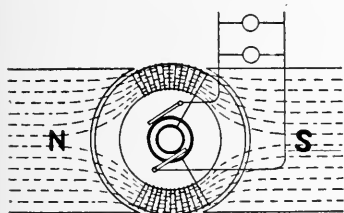

FIG. 357

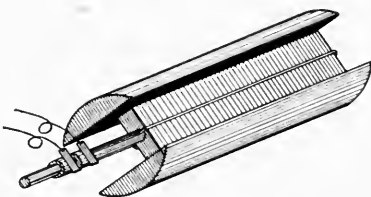

FIG. 358—MAGNETO ARMATURE

air space between the fields is as nearly filled with the armature as possible. Fig. 357 shows the path of the magnetic lines through a ring armature.

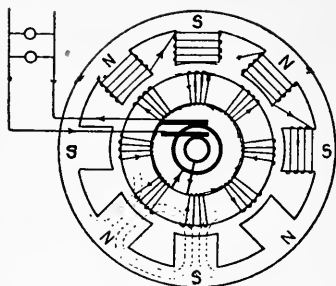

FIG. 359—SYSTEM OF WIRING FOR A MULTIPOLAR ALTERNATOR

### 638. Magneto alternator.

—Fig. 358 shows a magneto armature with the wires off. This is probably the most simple commercial electrical-current generator used. It is only applicable for such uses as cigar lighters, telephone calls and line testers.

For large purposes it is too inefficient.

**639. Multipolar alternator.**—The number of alternations in a dynamo as just described is 4,000 a minute with a speed of 2,000 revolutions a minute. This speed is as high as advisable, but the number of alternations is only about half as high as is considered good practice. For this reason large commercial dynamos are built with several poles, as shown by Fig. 359, and the number of revolutions reduced. The dotted lines in Fig. 359 represent the directions and paths of the lines of force. The full lines indicate the windings, and the arrowheads the direction of current. By carefully following out the direction of the induced current it will be seen that the coils passing beneath the north poles have a current set up in them which is opposite in direction to that set up in the coils passing under the south poles. By inspecting the windings it will be noted that the direction is reversed between each set of poles, hence the current set up through the system is the sum of all the currents set up at each pole. As the coils of the armature pass across the points midway between the poles, the direction of current is alternated. The number of alternations to the minute is found by multiplying the number of poles by the number of revolutions to the minute.

**640. Direct-current dynamo.**—For a great many purposes it is desirable to have a direct current, that is, one which always flows in one direction the same as a current from a cell. To do this some device must be applied to the dynamo just at the point where the current leaves the armature and before it reaches the external circuit. This device as used in a direct-current dynamo is known as a commutator.

*Commutators* are practically split rings secured to, but insulated from, the shaft of the armature. They take the place of the accumulating rings of the alternator. Each part of the commutator is insulated from the other parts.

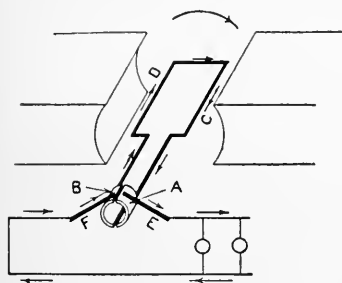

FIG. 360

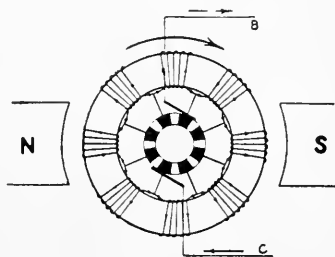

FIG. 361

*Principle of the commutator.*—Fig. 360 shows a simple commutator connected to a coil which represents an armature. *A* and *B* are the segments of the metal ring, each of which is connected to the armature. As the armature rotates in the direction indicated by the arrow the current passes off through the side *C*, out over the external circuit through the segment *A*, and in through the segment *B* and side *D*. When the side *D* has passed into the position of side *C*, the current goes out over the circuit in a similar manner. The brushes *E* and *F* must

be set so they close contact with each side respectively and make contact with the other side at the instant the current in the armature changes direction.

**641. Ring armature, direct-current dynamo.**—A ring armature may be made for a direct-current dynamo by winding on the iron ring a series of coils, the ending of each coil being connected to the beginning of the next. The junction of the two is connected to a section of the commutator. As the number of groups of coils is increased the number of sections of the commutator must also be increased. An eight-coil ring armature is shown in Fig. 361; the direction of current is indicated by the arrows. The induced current from both halves of the armature flows up toward the positive brush *B*, out over the external circuit, back in through the negative brush *C* and through each half of the armature to *B* again. As each coil passes from the field of the N pole and enters the field of the S pole, commutation takes place and the direction of current is reversed. The brushes are located at this point and the current from both sides is conducted off on the same wire. When the brushes pass from one of the commutator bars to another there is an instant when the armature sections are short-circuited; but this is at the instant when these coils are moving parallel to the lines of force, hence there is no current passing through them.

**642. Drum armature, direct-current dynamo.**—Instead of winding the armature coils upon an iron ring sometimes they are wound upon a drum. Fig. 362 shows the principle of the drum-wound armature suitable for a bipolar field. Like the windings of the ring armature the coils are in series and both halves are parallel with the external circuit.

**643. Comparison of the drum and ring armature.**—By

reference to Fig. 357 of a ring armature it will be noticed that the inside parts of each coil on the armature do not cut lines of force, hence these lines conduct only the current and may be known as so much dead wire. In the drum-wound armature both sides of the coil cut lines

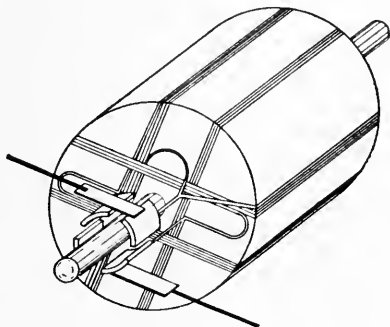

FIG. 362—DRUM ARMATURE

of force and the only dead wire is across each end. Although the drum-wound armature has less dead wire than the ring-wound, it is not as convenient to repair. For this reason high-voltage direct-current arc-lighting dynamos are generally constructed with ring armatures. A combination of the two, which is known as a drum-wound ring armature, is extensively used in practice.

**644. Self-exciting principle of dynamos.**—In the earlier types of dynamos the field magnets were always separately excited by either a battery or a magneto. Later it was learned that the soft iron of the field magnet after once being excited retains some of the magnetism. Since then all direct-current dynamos are built on this principle. There is sufficient magnetism remaining in the fields so that when the armature is up to speed it cuts enough

lines of force to induce a small current into the circuit around the field coils. This current more highly excites the field magnets until the dynamo soon picks up or establishes its rated E.M.F.

**645. Shunt dynamo.**—In the so-called shunt-wound dynamo a small portion of the current is led off from the brushes *bb* (Fig. 363), and through a great many turns of very fine wire which encircle the core of the magnet. In such a dynamo, as the load increases the E.M.F. slightly decreases, and as the load decreases the

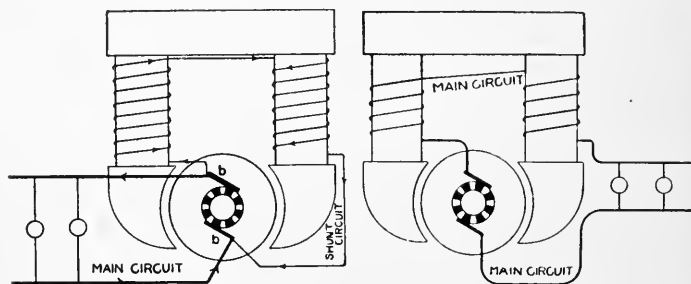

FIG. 363—SHUNT-WOUND DYNAMO      FIG. 364—SERIES-WOUND DYNAMO

E.M.F. increases. Hence, if the current fluctuations are great and quite frequent it would keep an attendant occupied to keep the field resistance regulated for the load. (See Fig. 368.)

**646. Series-wound dynamo.**—In the so-called series-wound machines the whole of the current is carried through a few turns of very coarse wire which encircles the field magnets (Fig. 364). Since every change of current alters the field magnetizing current, consequently in the current induced in the armature the E.M.F. at the brushes will vary with every change of resistance in the external circuit.

**647. Compound-wound dynamo.**—In the compound-



wound machines there is both a series and a shunt coil surrounding the cores of the field magnets. This style of machine is designed to give automatically a better regulation of voltage on constant-potential circuits than is possible on the shunt-wound machines, and yet possesses the characteristics of both the series and shunt machines. Like the shunt machine a part of the current is shunted from the brushes and around the magnet cores, also the external circuit is thrown around these cores. These machines are designed especially for conditions in which the load is very variable, as street car work, incandescent lighting and for commercial power purposes.

**648. Classification of dynamos.** — Dynamos may be classified according to their mechanical arrangement as follows :

1. Stationary field magnet with revolving armature.
2. Stationary armature with revolving field magnet.
3. Stationary armature and stationary field magnet with revolving core.

They may also be classified by mechanical designs as follows :

1. Direct-current machines.
2. Alternating-current machines.

And by electrical arrangement as

3. Shunt-wound.
4. Series-wound.
5. Compound-wound.

**649. Armatures.**—The armature core introduced into the magnetic circuit to help lower the reluctance is also an electrical conductor, and when rotated in a magnetic field will have currents set up within itself. These currents are independent of the external circuit, hence are

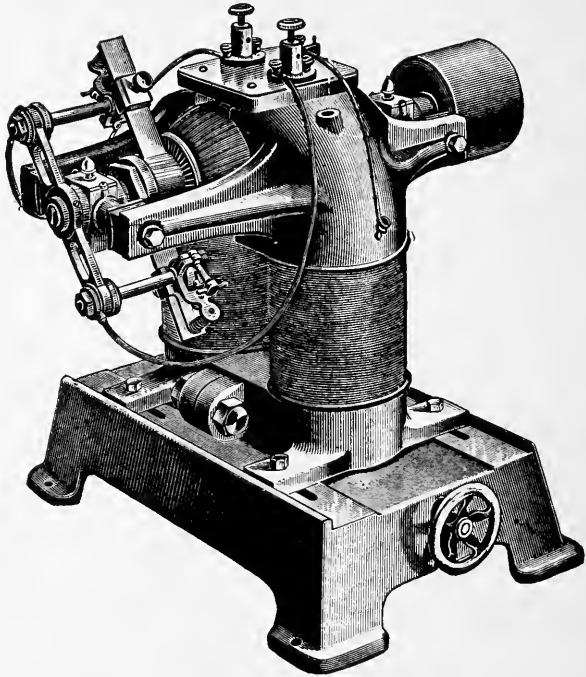

FIG. 365—BIPOLAR DIRECT-CURRENT DYNAMO

a loss. They are known as eddy currents and the loss is termed **eddy current** loss. Fig. 366 shows a section of a solid armature and the direction of these currents. Not only do these currents create a loss themselves but they heat the armature windings and thus increase the armature resistance. If these large eddy currents can be broken up into smaller ones the loss will not be so great. To break up these eddies armatures are now generally built up of a large number of sheets of iron with insulation between the sheets. The insulation used for this

purpose is generally a coat of rust or a sheet of tissue paper.

**650. Hysteresis.**—Another source of loss in an armature is due to the fact that every time the current alternates the polarity of the magnetism is reversed. If the armature is making 2,000 revolutions a minute and there are two alterations in each revolution there would be 4,000 alterations of the magnetism. This causes heat in the armature which is not accounted for in the external circuit, hence is a loss. Not only is there loss by heat in the armature, but the heat acts on the coils and increases the resistance in them and creates another loss. The loss in an armature due to these alterations of magnetism and the heat produced thereby is known as hysteresis loss.

**651. Insulation of an armature.**—The insulation of an armature is probably the most essential part of a dynamo. After it is put on in the various places where it is needed it must be baked and all moisture evaporated out of it. After an armature is thoroughly prepared for use it is generally tested for poor insulation. The potential difference for the test is about eight times as much as the armature is expected to carry. If there is any place where the electricity breaks through the insulation it is detected by means of a sensitive galvanometer.

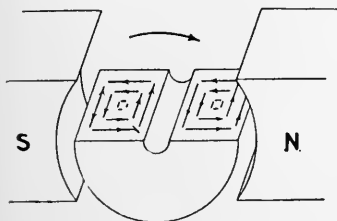

FIG. 366

**652. Capacity of dynamos.**

—It would seem that the amount of current that a dynamo could produce might be indefinite if enough power be supplied. This is true in a certain sense, but there is a limit and this will appear in one of the following ways:

**653. By poor regulation of voltage.**—An overload will cause an excessive drop of the E.M.F. at the machine. This will decrease the potential difference at the brushes and cause a weak current over the line.

*By excessive heating.*—The heat from an armature increases four times for each doubling of the current. At this rate the armature would soon become red hot. It would work at a little less than red heat, but even this much heat would break down the insulation. The armature should not become warmer than  $212^{\circ}$  F., and the general custom is not to run it at a higher temperature than  $70^{\circ}$  above the surrounding air.

**654. Commercial rating of dynamos.**—Dynamos are rated according to the number of kilowatts they will carry in the external circuit without excessive heating. For example, a person calls for a 60 K. W. 110-volt generator. This means that he desires a machine which will deliver 60 K. W. to the external circuit and maintain a potential difference of 110 volts across the brushes. Owing to losses in the machine such a machine may develop 63 K. W. and still have only 60 K. W. available for use in the external circuit.

**655. Efficiency of dynamos.**—The efficiency of a dynamo is the ratio of its electrical output to the mechanical energy exerted upon it. For a 1 K. W. machine it is only about 50 per cent, and in generation of several thousand kilowatts it is about 95 per cent.

**656. Sparking at the commutator.**—Sparking at the commutator is the most serious trouble the attendant will have with a dynamo, provided he keeps all other parts clean, and the insulation does not break down or the machine become short-circuited. There are several causes for a dynamo to spark, some of which are:

1. Brushes not set at neutral point. This can be remedied by

working the brushes back and forth until the proper position is located.

2. Brushes not spaced according to commutator bars. The commutator bars should be carefully counted and the brushes accurately set between them.
3. Brushes do not bear against commutator with sufficient pressure.
4. Brushes do not bear on the commutator with a perfect surface.
5. Collection of dirt and grease which prevents good contact of the brushes on the commutator.
6. A high or low commutator bar which causes poor contact.
7. Commutator not worn perfectly round, consequently poor contact with the brushes.

**657. Repairing a dynamo.**—If the insulation breaks down, a wire burns out or the commutator becomes worn out of round, an expert should be called in, and generally the defective part will have to be sent to the factory for repairs. Sometimes a good machinist can put the armature in a metal lathe and turn it down round. A good man with a file can work down a high bar, and holding a piece of sandpaper on the commutator while it is in motion will clean it of all oil and dirt.

## MOTORS.

**658. Comparison with a dynamo.**—A dynamo is a machine for converting mechanical energy into electrical. An electrical motor is just the reverse; it is a machine for converting electrical energy into mechanical. Any machine that can be used as a dynamo can when supplied with electrical power be used as a motor. Dynamos and motors are convertible machines; thus the various discussions will apply as well to the motor as to the dynamo.

**659. Principles of the motor.**—It has been shown that when a coil of wire is placed in a magnetic field and rotated an electrical current is produced. If the opposite of this is done, i.e., if a current is passed through the

coil, the coil will tend to rotate. This is the principle of the electric motor: instead of taking a current off of the armature, one is put into it and at the same time sent through the fields. The current passing through the

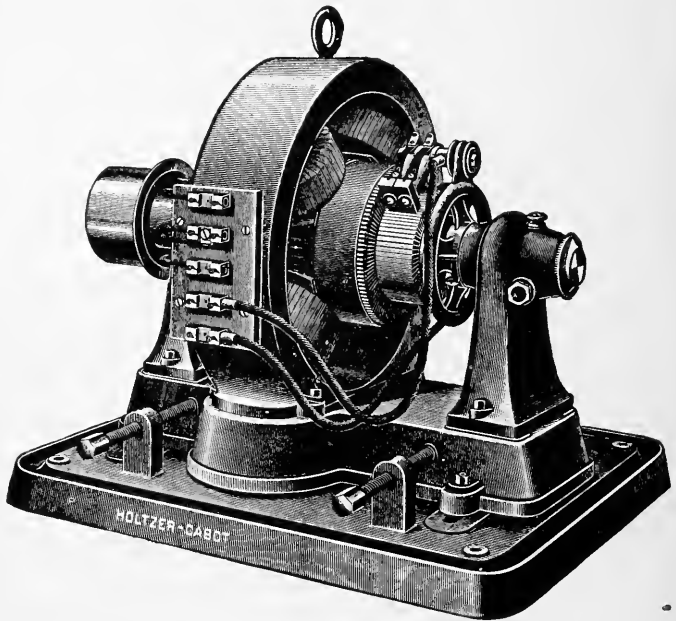

FIG. 367—MULTIPOLAR MOTOR

fields induces magnetism in them; the lines of force produced by this magnetism draw on the armature and cause it to revolve. By studying Fig. 356 it will be noticed that the coil will revolve until the plane of the coil is parallel to the lines of force, and then stop. This same condition would take place in the motor if it were not for the commutator. Just at the instant the coil is brought to the position to stop, the commutator changes the di-

rection of the current and the turning effect is thrown to the other side and the armature moves on.

*Counter electromotive force of a motor.*—The armature wires of a motor rotating in its own magnetic field cut the lines of force as if the motor were being driven as a dynamo, consequently there is an induced E.M.F. in them. The direction of this induced E.M.F. is opposite to that of the applied pressure. Such an induced E.M.F. is known as counter electromotive force and is an important property of the motor. A motor without load will run with sufficient speed that its counter electromotive force will very nearly equal the applied pressure. The counter E.M.F. will never be as great as the applied force. There will always be a difference between these, equal to the loss due to resistance in the motor armature. The power of a motor increases as the counter E.M.F. decreases until the counter E.M.F. is one-half of the applied E.M.F., then the power of the motor decreases. The maximum power of a motor is reached when the counter E.M.F. is one-half of the applied E.M.F.

*Losses of a motor.*—The losses of a motor, like those of a dynamo, are due to resistance in the armature friction, eddy currents and hysteresis.

**660. Operating motors.**—The resistance in the armature of a motor is so low that if a motor were directly connected to the supply mains, too great a current would flow through it before a counter E.M.F. could be set up, consequently the machine would be practically short-circuited and the windings damaged. For this reason a rheostat known as a starting rheostat is inserted into the armature circuit of a shunt motor. To start the motor, switch *A* (Fig. 368) is closed, and this throws the current into the fields and excites them; then the arm is moved over the starting box to point one, and when

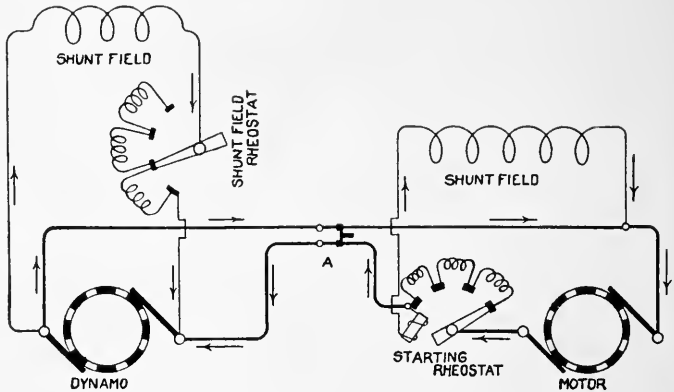

FIG. 368—WIRING SYSTEM FOR DYNAMO AND MOTOR

the motor has attained its speed for this point it is moved on up to point two, then three, and so on until the last point is reached and the motor is directly connected to the feed wire. To stop the motor, switch *A* should be opened, and if the arm *B* is not an automatic shifter, it should be thrown back to its original position ready for starting the next time. Most of these arms are now made so they work against a spring, and when the last point is reached an electromagnet attracts the arm sufficiently to hold it in position; then when the circuit is broken the magnet loses its attraction for the arm, and the spring draws it back.

**661. The electric arc.**—When a current of from 6 to 10 amperes under a pressure of about 45 volts is passed through two rods of carbon with their ends first in contact, then gradually drawn apart to a distance of about  $1/8$  inch, a brilliant arc of flame is established between them. This arc, known as the electric arc, is made of a vapor of carbon. As the current passes across the contact points the high resistance produces enough heat to



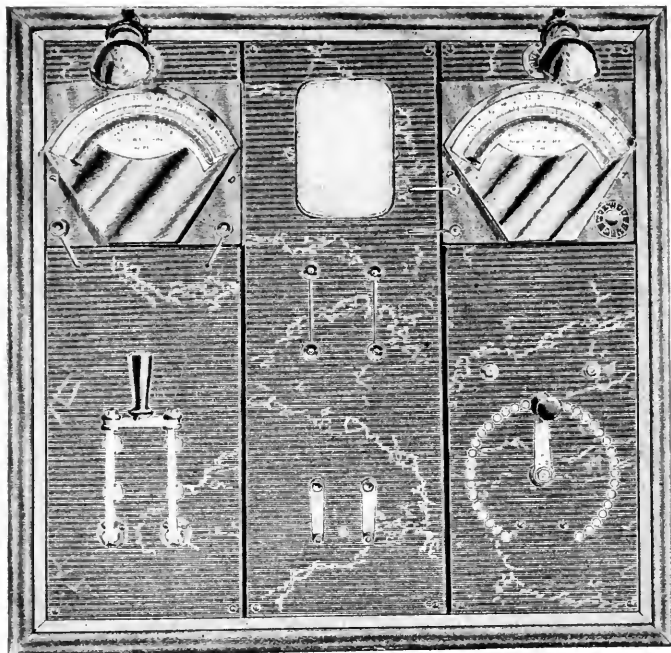

FIG. 369—COMMERCIAL SWITCHBOARD

disintegrate the carbon and cause it practically to boil; this boiling throws off a vapor which is a conductor of electricity and as a consequence conducts the current across the gap. The temperature of the arc at its hottest point is about  $3,500^{\circ}$  C., which is about twice the temperature required to melt platinum, the most refractory of metals.

Arc lamps are rated according to the watts consumed. They generally range from  $6 \times 45 = 270$  watts to  $10 \times 45 = 450$  watts. About 12 per cent of the energy supplied to an arc light really appears as light; the rest goes to produce the heat evolved.

Since the carbons of the arc lights are constantly wasting away there must be some device to regulate the distance they are from each other and to work automatically to keep them at this distance. An ingenious appliance of electromagnets and clutches accomplishes this action and is explained in any book upon electric lighting.

**662. Incandescent lamps.**—It is on the principle of the

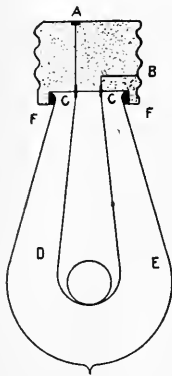

FIG. 370—INCANDESCENT LAMP

heated wire that we get light from the incandescent lamp. Referring to Fig. 370, connections are made with the lamp at *A* and *B*. At *CC* are bits of platinum wires attached to the carbonized filament *D*. *E* is the highly exhausted globe. If the carbonized filament were in the air, the intense heat created within it due to the resistance of the current would immediately burn it up, but since it is in almost perfect vacuum, it will last from 600 to 800 hours. Even at the end of this period the filament does not always break, but it becomes so disintegrated that the candle power is low and further use is not satisfactory.

**663. Commercial rating of incandescent lamps.**—Before a lamp is put upon the market it is compared with a lamp of known brilliancy. While it is being compared with the standard lamp, measurements of its voltage and current are made. After this is done the lamp is labeled with the voltage it carries, its candle power and watts consumption. A 16 C.P. 60-watt 110-volt lamp will require

$$C = \frac{W}{E} = \frac{160}{110} = .55 + \text{amperes.}$$

Lamps are usually made for circuits of 50 to 60 volts, 110 to 115 volts and 220 volts with constant potential.

A 16 C.P. lamp requiring 55 watts on a 50-volt circuit will take about one ampere; on a 110-volt circuit it will take 0.5 ampere; on a 220-volt circuit about 0.25 ampere. A lamp should not be subjected to a voltage higher than its rating; the filament is not made for it and will soon give out.

*The efficiency of a lamp* is proportional to the ratio of the number of candles it will produce to the number of watts it absorbs. A high efficiency is 3 watts per candle power, and the average efficiency is 3.5 watts candle power. High-efficiency lamps are used where the pressure is very closely regulated or cost of power is high, and low-efficiency lamps are used where there is not such close regulation and power is less expensive.

**664. Potential distribution in lamp circuits.**—Incandescent lamps are usually operated from low-voltage constant-potential circuits. Where lamps are supplied with current from a street car circuit, which generally has a potential of 500 volts, they are grouped in multiple series; i.e., 5 100-volt lamps or 10 50-volt lamps will be connected across the mains. In a series circuit the drop on the lead wires does not interfere with the regulation of the voltage at the terminals, but in a parallel circuit this drop is an important factor and requires that the lamps be distributed and the size of wire proportioned so that each lamp receives about the same voltage. For example, consider 100 220-volt lamps to be connected at distances along a pair of mains which extend 500 feet from a generator which has a potential difference of 225 volts at the brushes. The lamps nearest the dynamo will receive a greater potential than their rated capacity and will often burn out, while those farthest from the dynamo will not receive potential equal to their capacity, hence will burn dimly. In order to overcome this, centers of distribution

are laid out in wiring construction and groups of lamps are fed from these centers Fig. 371. Feed wires are run from the generators to these centers and a constant potential is kept in them by regulation at the generator. Sets of mains are run from these centers, and then sub-mains are led off from these mains to supply subcenters of distribution. To these subcenters

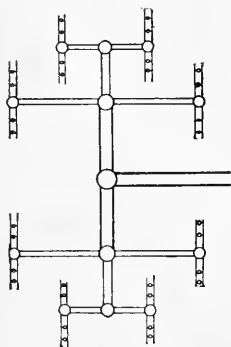

FIG. 371—PARALLEL  
CIRCUIT WIRING

lead wires to the lamps are connected. In this system of wiring it does not matter if there is a fall of potential of 20 per cent, between lamps and generators, for the fall is alike in all. For example, a voltmeter across the brushes of a generator shows 225 volts, one at the main center of distribution shows only 218 volts, one at the subcenters shows only 212 volts and one across the terminals of the lamp shows only 210 volts. But since there has been the same number of divisions and subdivisions

the P.D. of all of the lamps is the same.

**665. Calculations for incandescent wiring.**—To find the size of wire for carrying a certain current, let

C. M. = circular mil area of wire,

K = 10.79 = resistance 1 mil foot of copper wire.

L = length of circuit in feet,

C = current in amperes,

E = volts drop on the line.

In the formula,

$$C M. = \frac{K \times L \times C}{E} = \frac{10.79 \times L \times C}{E}$$

After obtaining the circular mil area, this must be compared with a wire table to get the number of wire to use.

**Example.**—Fifty 55-watt 110-volt lamps are connected in parallel to a center of distribution located 100 feet from a dynamo which generates 112 P.D. By measurement the potential at the point of distribution is 110 volts. What size wire is required for the feeder?

To find amperes to be conducted.

$$C = \frac{W}{E} = \frac{55}{110} = 0.5 \text{ per lamp.}$$

$$0.5 \times 50 = 25 \text{ amperes for all lamps.}$$

$$112 - 110 = 2 \text{ volts drop on line.}$$

$$\text{C.M.} = \frac{K \times L \times C}{E} = \frac{10.79 \times (100 \times 2) \times 25}{2} = 26,975.$$

C. M. = circular mil area.

K = 10.79.

L =  $100 \times 2 = 200$  feet.

C = 25.

By comparison with the wire table (670) the next larger size than 26,975 is B. & S. No. 5.

**Wiring calculations for a motor.**—To find the size of wire to transmit any given horse power any distance when the voltage and efficiency are known.

$$\text{C.M.} = \frac{\text{H.P.} \times 746 \times L \times 10.79}{E \times e \times \%M}$$

E = voltage required by motor.

e = drop on line.

H. P. = horse power of motor.

% M = efficiency of motor in decimals.

**Example.**—What size of wire is required to conduct current to a 220-volt 6 H.P. motor located 175 feet from the dynamo? The drop on the line is to be 6 volts and the efficiency of the motor 80 per cent:

$$\begin{aligned} \text{C.M.} &= \frac{\text{H.P.} \times 746 \times L \times 10.79}{E \times e \times \%M} \\ &= \frac{6 \times 746 \times 175 \times 2 \times 10.79}{220 \times 6 \times .80} \\ &= 15,984 \text{ C. M.} \\ &= \text{No. 8 B. \& S.} \end{aligned}$$

To find the current required by a motor when the horse power, efficiency and voltage are known.

$$C = \frac{\text{H. P.} \times 746}{E \times \%M}$$

**Example.**—What current is furnished to the motor in the previous problem?

$$\begin{aligned} C &= \frac{\text{H. P.} \times 746}{E \times \%M} \\ &= \frac{6 \times 746}{220 \times .80} \\ &= 25.4 \text{ amperes.} \end{aligned}$$

## INDUCTION COILS AND TRANSFORMERS

**666. Self-induction.**—Self-induction is defined as the cutting of a wire by the lines of force flowing through the wire. When a current begins to flow through a wire magnetic whirls spring outward from the wire and cut it. This cutting of the wire with only its own magnetic lines of force induces an E.M.F. for an instant. But the E.M.F. which it does induce has an opposite direction to the E.M.F. which causes the current to flow. Hence the E.M.F. will be retarded for an instant by its own induced E.M.F. and will not flow until this is overcome. When the current flowing through the wire is stopped the lines of force again cut the wire but in an opposite direction, hence this time they tend to retard the cessation of flow of the current. The effects of self-induction are rarely noticeable in a straight wire, but when the wire is wound into coils in the form of a helix the magnetic field of every turn cuts many adjacent turns and the E.M.F. is greatly increased, being proportional to the current, the number of turns and the magnetic lines through the coil. If an iron core is placed within the coil the effects of self-induction are very much greater. By snapping the wires from a battery after passing through such a coil as described above a brilliant spark will be produced. This is the simple coil (Fig. 372) used in make-and-break ignition on gasoline engines.

**667. Induction coil.**—If two coils entirely separate from each other be wound around an iron core and connected up as in Fig. 373 every time the current is started in coil *a* there will be a deflection of the galvanometer needle in *b*. If the current is broken in *a* the needle *b* will again be deflected, but in an opposite direction. From this it is seen that the magnetic lines of force which surround the wire in coil *a* induce a current in the coil *b*.

This is the principle of the induction coil, a diagram of the connections being shown in Fig. 374. The circuit leading from the batteries to the inside of the coil is known as the primary and the circuit wound on the out-



FIG. 372

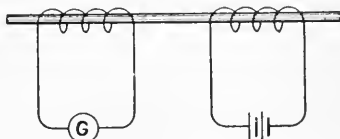

FIG. 373

side of this is known as the secondary. The primary induces the current in the secondary, and if the secondary circuit has more turns of wire than the primary it will have a correspondingly greater E.M.F., in other words, the difference in E.M.F. of the two circuits varies directly with the difference in the number of turns in the wire of the two. Since the induced E.M.F. is set up only as the current is made or broken, an automatic device *A*

is connected into the primary, whose action is identical with the circuit breaker of an electric bell. In induction coils this, however, is generally known as a buzzer.

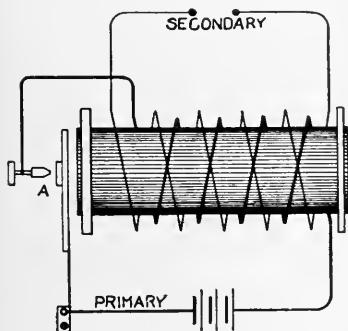

FIG. 374—PRINCIPLE OF THE INDUCTION COIL

The induction coil is used with jump-spark ignition, on gasoline engines. For this work the spark requires such a high E.M.F. that the primary consists of only a few turns of coarse wire, while the secondary consists of several thousand turns of fine wire.

**668. Transformers.**—Where alternating currents are used for electric lighting, to make the cost of transmission a minimum a voltage of 1,100 to 2,200 or even higher is used; this is far too high to be taken into houses and so a transformer is connected into the circuit. A transformer is identical with the induction coil with the automatic circuit breaker removed. A transformer, however, usually decreases the E.M.F. instead of increasing it. This is done by having the primary enter the coil on a large number of turns and the secondary pass off on a few turns. Since the current is alternating in action, it takes the place of a circuit breaker.

**669. Copper wire table.**

Gauge, A. W. G. B. & S.	Diameter, Inches	Area, Circular Mils	Weight Pounds per 1,000 Feet	Length, Feet per Pound	Ohms Resistance per 1000 Feet
0	0.3249	105,500	319.5	3.130	0.09960
1	0.2893	83,690	253.3	3.947	0.1256
2	0.2576	66,370	200.9	4.977	0.1584
3	0.2294	52,630	159.3	6.276	0.1997
4	0.2043	41,740	126.4	7.914	0.2518
5	0.1819	33,100	100.2	9.980	0.3176
6	0.1620	26,250	79.46	12.58	0.4004
7	0.1443	20,820	63.02	15.87	0.5048
8	0.1285	16,510	49.98	20.01	0.6367
9	0.1144	13,090	39.63	25.23	0.8028
10	0.1019	10,380	31.43	31.82	1.012
11	0.09074	8,234	24.93	40.12	1.276
12	0.08081	6,530	19.77	50.59	1.610
13	0.07196	5,178	15.68	63.79	2.029
14	0.06408	4,107	12.43	80.44	2.559
15	0.05707	3,257	9.858	101.4	3.227
16	0.05082	2,583	7.818	127.9	4.070



## CHAPTER XXIII

### THE FARM SHOP

**670. Necessity.**—There is no farm so small but a farm shop would be of value. For small farms there should not be many tools, but there is seldom a year when a small investment in a bench with a vise and a few tools would not return to the user a good dividend. It is not alone the amount of money which can be saved by doing a large per cent of one's own repairing, but it is the time saved in emergencies.

Often breakages occur with farm machinery which, if the tools are at hand, may be repaired in much less time than is required to take the broken parts to a repair shop where the job must wait its turn with others equally urgent. There are times when farm work is very pressing and a delay of a few hours means a loss of many dollars in wasted crops.

Not only is there a loss by not having a shop for urgent repairs, but there are rainy and disagreeable days, when men do not relish working outside, that can very profitably be put in working in the shop.

**671. Use.**—The idea is prevalent that only skilled mechanics can do work in a shop. Of course this is true in a great many instances where the work is difficult, but there are more times when the work is such that a man with only ordinary mechanical ability can do it. The farmer should not attempt to point plows, weld mowing machine pitmans and do such work until he has achieved skill. However, he can tighten horseshoes, repair castings, etc., as well as do carpentry work.

**672. Location.**—The location of the shop depends greatly upon circumstances and taste. If the shop is equipped with only a work bench and the tools which go with it, it can be built in the barn, or a part of the machine shed, be used. In fact a suitable place can be arranged almost anywhere. To locate a shop with a forge in the equipment is a little more trouble. It should be a separate building and far enough away from the other buildings so that in case it should catch fire the other buildings could be saved. Should the owner of a farm

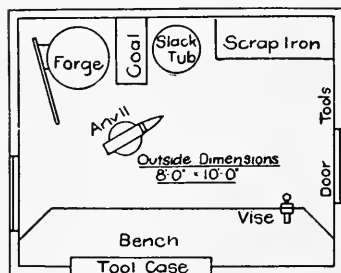

FIG. 375—ARRANGEMENT OF A SMALL SHOP

shop be fortunate enough to possess a gasoline engine or some similar source of power, the engine can very handily be placed in a room adjoining the shop and a shaft run one way into the shop and another way into the granary where the sheller and grinder may be located.

**673. Construction.**—That part of the shop floor about the forge and anvil should be of earth or concrete, and if concrete be used in this part it might as well be extended over all the floor space. The material and design of the outside of the shop should conform to the style of the other buildings about the place.

**674. Size.**—The size of the shop should conform to the size of the farm and a man's ability as a mechanic. A small farm does not require as well equipped a shop as a large one. A farm close to town does not require as large a shop as one several miles in the country. A man who is inclined to handle tools more or less will make very much more use of a shop than a man who will

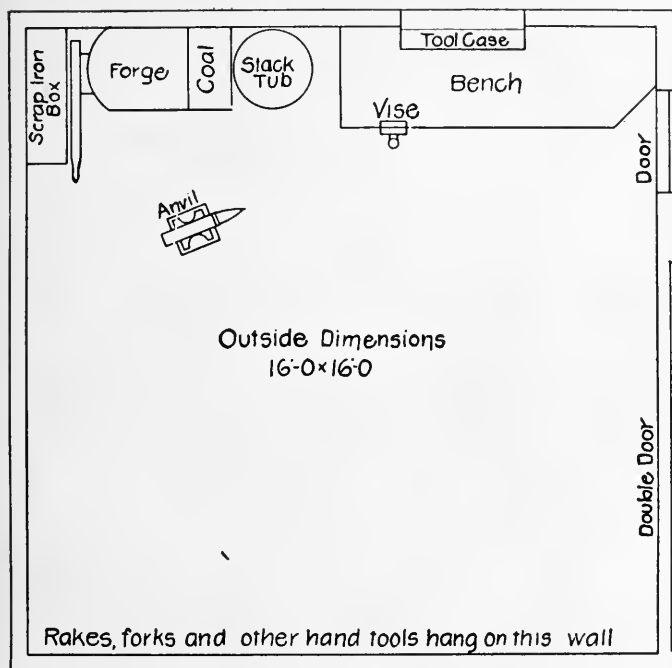

FIG. 376—ARRANGEMENT OF A LARGE SHOP

use it only when dire necessity requires, consequently the man who uses the shop frequently needs a larger one than the man who very seldom enters it. A shop with a floor space of  $8 \times 10$  is large enough for a bench with a few hand tools and a small portable forge.

If one desires to have his shop large enough so that a wagon can be run in for repairs it should be about  $16 \times 16$  feet. It might seem that this would be a waste of space, but that part of the shop where the wagons stand for repairs can be used for a wagon shed all the rest of the time.

**675. Equipment.**—The following is a list of tools suggested for a farm of 160 to 320 acres. The cost of the wood tools is from \$15 to \$20, according to grade, and the cost of the forge tools from \$25 to \$35. The anvil referred to in this list is cast iron with steel face; if a wrought-iron anvil with a steel face be substituted for it an addition of about 5 cents for each pound weight should be added.

## LIST

### Wood Tools

- I rip saw, 5-point.
- I panel saw, 10-point.
- I 12-inch compass saw.
- I steel square.
- I 8-inch sliding tee bevel.
- I set bits.
- I each  $\frac{1}{4}$ -,  $\frac{3}{8}$ -,  $\frac{5}{8}$ -, and 1-inch socket firmer chisels.
- I 20-inch fore plane.
- I 8-inch smooth plane.
- I ratchet brace, 10-inch sweep.
- I marking gauge.
- I 8-inch screw driver.
- I  $\frac{3}{8}$ -inch socket firmer gouge.
- I 2  $\times$  1  $\times$  8-inch oil stone.
- I 8-inch try square.
- I  $1\frac{1}{8}$   $\times$  15-inch bench screw.
- I pocket level.
- I drawing knife.
- I expansive bit.
- I 4  $\times$  6 lignum-vitæ mallet.
- I pair 12-inch carpenter's pincers.

### Forge Tools

- I forge.
- I pair 20-inch straight-lipped blacksmith tongs.
- I 80-pound cast-iron anvil with steel face.
- I 17 $\frac{1}{8}$ -pound ball pein hammer.
- I hardie to fit anvil.
- I 12-pound steel sledge with handle.
- I 55-pound solid box vise.
- I Champion post drill.
- I set dies and taps.

LITERATURE WHICH HAS BEEN CONSULTED IN THE  
PREPARATION OF "FARM MACHINERY AND  
FARM MOTORS"

- The Influence of Farm Machinery on Production and Labor. By N. W. Quaintance. 1904. Publication of the American Economic Association, Vol. V., No. 4.
- Theoretical Mechanics. By L. M. Hoskins. 1900. Stanford.
- Mechanics of Engineering. By I. P. Church. John Wiley & Sons, New York.
- General Physics. By C. S. Hastings and F. E. Beach. 1900. Ginn & Company, Boston.
- Text Book of the Mechanics of Materials. By Mansfield Merriman. 1901. John Wiley & Sons, New York.
- The Materials of Construction. By J. B. Johnson. 1903. John Wiley & Sons, New York.
- Experimental Engineering. By R. C. Carpenter. 1902. John Wiley & Sons, New York.
- The Book of Farm Implements and Machines. By James Slight and R. Scott Burn. 1858. William Blackwood & Sons, Edinburgh.
- Bulletin No. 103, Evolution of Reaping Machines. By M. F. Miller. 1902. U. S. Department of Agriculture.
- Physics of Agriculture, Chapters XI., XVI., XX., XXII. and XXIII. By F. H. King. 1901. Madison.
- Farm Implements and Farm Machinery. By J. J. Thomas. 1869. Orange Judd Co., New York.
- Cyclopedia of American Agriculture, Vol. I., pp. 203-231, 387-398. 1907. Macmillan Co., New York.
- Farm Engineering. By John Scott. 1885. Crosby Lockwood & Co., London.
- The Fertility of the Land. By I. P. Roberts. 1904. The Macmillan Co., New York.
- Kent's Mechanical Engineers' Pocket-Book. By William Kent. 1906. John Wiley & Sons, New York.
- Architects' and Builders' Pocket-Book. By F. E. Kidder. 1905. John Wiley & Sons, New York.
- Twelfth Census of the United States.
- Science of Threshing. By G. F. Conner. The Thresherman's Review, St. Joseph, Michigan.
- Bulletin No. 6, Trial of Sleds and Tillage Tools, and Bulletin No. 7, Draft of Mowing Machines. By J. W. Sanborn. Utah Experiment Station.
- Bulletin No. 39, Influence of Width of Tire on Draft of Wagons. By H. J. Waters. 1897. Bulletin No. 52, Influence of Height of Wheel on the Draft of Farm Wagons. By T. I. Mairs. 1901. Missouri Experiment Station.
- Bulletin No. 68, One Year's Work Done by a 16-Foot Geared Wind-

- mill, and Bulletin No. 82, Experiments in Grinding with Small Steel Feed Mills. By F. H. King. 1898 and 1900. Wisconsin Experiment Station.
- Mechanics of Pumping Machinery. By Julius Weisbach and Gustav Herrmann. 1897. Macmillan Co., New York.
- Science of Successful Threshing. By Dingee and MacGregor. 1907. J. I. Case Threshing Machine Co., Racine, Wis.
- The Animal as a Machine and Prime Mover. By R. H. Thurston. 1894. John Wiley & Sons, New York.
- Haulage by Horses. By Thomas H. Brigg. 1893. Transactions of the American Society of Mechanical Engineers, Vol. XIV.
- The Windmill as a Prime Mover. By Alfred R. Wolff. 1900. John Wiley & Sons.
- Bulletin No. 59. The Homemade Windmills of Nebraska. By E. H. Barbour, Nebraska Experiment Station.
- Steam Boilers. By C. H. Peabody and E. F. Miller. 1902. John Wiley & Sons.
- Modern Steam Engineering. By Gardner D. Hiscox. 1907. The Norman W. Henley Publishing Co., New York.
- The Steam Boiler. By Stephen Roper, 1897. David McKay, Publisher, Philadelphia.
- The Traction Engine Catechism. Compiled by the Thresherman's Review. 1906. St. Joseph, Mich.
- Instructions for Traction and Stationary Engineers. By William Boss. 1906. The Author, St. Anthony Park, Minn.
- The Traction Engine. By J. H. Maggard. 1902. David McKay, Publisher, Philadelphia.
- Rough and Tumble Engineering. By J. H. Maggard, Iowa City.
- Farm Engines and How to Run Them. By J. H. Stephenson. 1903. Frederick J. Drake & Co., Chicago.
- The Gas and Oil Engine. By Dugald Clerk. 1899. John Wiley & Sons, New York.
- The Gas Engine. By F. R. Hutton. John Wiley & Sons, New York.
- The Practical Gas and Gasoline Engineer. By E. W. Longanecker. 1903. The Acme, Publisher, Chicago.
- Bulletin No. 93, Comparative Values of Alcohol and Gasoline for Light and Power. By J. B. Davidson and M. L. King. 1907. Iowa Experiment Station.
- Bulletin No. 191, Tests of Internal Combustion Engines on Alcohol Fuel. By C. E. Lucke and S. M. Woodward. 1907. U. S. Department of Agriculture.
- Dynamo Electric Machinery. By Samuel She'don. 1902. D. Van Nostrand Co., New York.
- Lessons in Practical Electricity. By C. Walton Swoope. Fourth Edition. D. Van Nostrand Co., New York.
- First Course in Physics. By R. A. Millikan and H. G. Gale. Ginn & Co., New York.
- Elementary Lessons in Electricity and Magnetism. By Silvanus Thompson. The Macmillan Co., New York.
- Steam Engine Theory and Practice. By William Ripper. 1899. Longmans, Green & Co., New York.

# INDEX

---

	PAGE		PAGE
Absorption dynamometers.....	18	Bearing surface at wing of share.....	70
Action of valves.....	430	Bell, electric.....	473
Adjusting the walking plow.....	75	Belting.....	28
sulky plow.....	75	canvas.....	30
Advantage, giving one horse the	14	care of leather.....	29
of the gasoline engine as a		"dressing.....	29
farm motor.....	432	lacing of.....	30
Agricultural engineering—defini-		leather.....	29
tion.....	9	link.....	31
Air cooled, the.....	420	Best conditions for work.....	293
Air for combustion.....	347	Bevel gears.....	37
Alcohol.....	434-435	Binders.....	143
Alfalfa harrow.....	85	draft of.....	153
Alfalfa mills.....	237	Bituminous or soft coals.....	348
Alternator, magneto.....	478	Blister.....	360
multipolar.....	478	Blow-off pipe.....	338
Ammeter.....	465	Blower and exhaust nozzle.....	328
Amperes.....	27	Blue heat.....	342
Anchor posts.....	313	Boilers, bag in.....	360
Angle of advance.....	372	capacity.....	339
Angularity of connecting rod....	381	classification.....	318
Animal as a motor, the.....	281	cleaning.....	358
Animals other than horse or mule		compounds.....	359
used for power.....	286	direct flue.....	329
Anthracite coal.....	347	externally fired.....	319
Arc, electric.....	490	horse power.....	340
Armature.....	476-483	internally fired.....	320
insulation of.....	485	laying up.....	360
Arrester, spark.....	339	locomotive type.....	321
Artificial magnets.....	460	open bottom type.....	324
Attaching indicator to engines... 383		principle.....	317
Attachments, threshing machine.. 214		return flue.....	324
self feed and hand cutter..... 214		round bottom type.....	324
stackers.....	215	steam.....	317
weighers.....	216	strength of.....	342
Attraction and repulsion, laws of		vertical.....	318
electrical.....	462	Boiler shell, strength of.....	344
Automatic cut-off governor.....	389	Boiling point.....	365
Bag in a boiler.....	360	Bolts, stay.....	343
Balanced valve.....	373	Bottom, plow.....	59
Baling presses.....	187	types of.....	63
box presses.....	188	Boxes, heating of.....	41
development.....	187	enclosed wheel.....	65
horse power presses.....	188	Bridges.....	455
power presses.....	189	British thermal unit.....	26
Banking the fire.....	355	Brushes.....	477
Bar share.....	56	Buggies and carriages.....	252
Barn tools.....	181	selection.....	252
Base.....	407	Burners, wood and cob.....	326
Batteries.....	419	straw.....	328
connection.....	419	Burr.....	46
Battle-ax mills.....	299	Cable transmission.....	34
Bean and pea threshers.....	218	Calculations for incandescent wir-	
Bearings.....	40, 398	ing.....	494
		Canvas belting.....	30

	PAGE		PAGE
Capacity .....	286	Corn machinery, development....	221
boiler .....	339	huskers and shredders.....	224
dynamos .....	485	Corn shellers.....	227
of the horse.....	292	development .....	227
Carburetion .....	430	types of modern.....	227
Carburetors .....	414	Corn planters.....	120
constant level.....	415	calibration of.....	131
float feed.....	416	development .....	120
Care of gasoline engines.....	427	development of check rower... 120	
Cassady, W. R.....	56	draft of .....	131
Cast iron.....	44, 343	hand planters.....	121
Cells .....	470	the modern planter.....	122
dry .....	471	Corrosion .....	357
Center, dead.....	374	Cost of production.....	5
Centrifugal pumps.....	269	Coulter.....	57
Changes, physical and mental... 3		Cracks .....	360
Chilled iron.....	44	Crank shaft .....	410
plow .....	65	Cultivators .....	91
Classification of dynamos..... 483		classification .....	91
of steam engines.....	364	development.....	91
of windmills.....	303	features of, with suggestions in	
Cleaning the fire.....	355	regard to selection.....	92
the boiler .....	358	listed corn.....	99
the flues.....	359	one-horse.....	91
Clover hullers.....	219	seats.....	93
Clutch .....	448	hammock.....	93
Coal, bituminous or soft.....	348	straddle.....	93
anthracite .....	347	single and double shovel..... 91	
semi-anthracite .....	348	wheels .....	96
Coefficient of friction.....	39	pivotal.....	97
Coils, magnetic properties of.... 472		boxes.....	96
induction .....	496	Current electricity.....	464
Columns, water.....	334	Currents induced in a coil by a	
Combustion .....	348	magnet .....	474
air for.....	349	rotating coil.....	475
heat of.....	349	Cylinder .....	408
volume of air for.....	350	head .....	408
Commercial rating of dynamos... 486		Davenport, F. S.....	56
incandescent lamps.....	492	Dead center.....	374
steam engines.....	394	locating .....	375
Commutators .....	479	Deere, John.....	55
principle of.....	479	Density of charge varies with	
Comparative resistance.....	467	form of surface.....	462
Comparison of the drum and ring		Development, muscular.....	285
armature.....	480	of the present-day windmill... 298	
motor with dynamo.....	487	Die for cutting threads.....	16
Compensating gears.....	451	Differential pulley.....	16
Compound, boiler.....	359	Direct flue boilers.....	329
engine .....	392	current dynamo.....	479
wound dynamos.....	483	ring armature.....	480
Compression .....	428	drum armature.....	480
Connecting rod.....	410	comparison .....	480
angularity of.....	381	Direct-reading dynamometer.... 20	
Connections, series.....	469	Direction of trace.....	289
parallel .....	469	Disk harrows.....	83
Constant level carburetors..... 415		cutaway.....	84
Construction .....	407	orchard.....	85
Cooling of gasoline engines.....	420	plow cut.....	87
Copper wire table.....	498	tongueless.....	87
Corn crushers.....	238	Disk plow.....	66
Corn drills.....	132	Division of work.....	294
Corn harvesting machinery..... 155		Double-cylinder engine.....	391
sled harvesters.....	157	Double-eccentric reverse.....	378
types of.....	158	Double-riveted lap joint.....	346
Corn machinery.....	221	Double-ported valves.....	373
feed and ensilage cutters..... 221			



	PAGE		PAGE
Draft of plows.....	73	Engines, internal combustion....	401
Draft, line of least.....	291	gasoline traction.....	401
Drawing the fire.....	356	mounting.....	446
Drills.....	110	steam.....	361
classification of.....	110	traction.....	436
construction.....	118	Erecting mills.....	313
disk.....	112	Eveners.....	14
draft of.....	118	two-horse.....	13
the hoe.....	110	Exhaust.....	430
the shoe.....	111	nozzle and blower.....	338
Drum armature direct-current		Expansion of steam.....	367
dynamos.....	480	work done during.....	368
Dry cells.....	471	Externally fired boilers.....	319
Dynamometers.....	18	Factor of safety.....	49
absorption.....	18	Factor upon which the value of	
direct-reading.....	20	induced E.M.F. depends... 475	
Giddings.....	23	Farm machinery, value and care	
self-recording.....	20	of.....	275
traction.....	19	Farm shop, construction.....	500
transmission.....	19	equipment.....	575
Dynamos.....	476	location.....	500
armature.....	477	necessity.....	499
brushes.....	477	size.....	500
capacity of.....	485	use.....	499
classification of.....	483	Feed and silage cutters.....	221
commercial rating.....	486	development.....	221
compound-wound.....	483	Feed mills.....	234
direct-current.....	479	development.....	234
efficiency of.....	486	power mills.....	235
multipolar alternator.....	478	alfalfa mills.....	237
repairing a.....	487	capacity of feed mills.....	237
self-exciting, principle of.....	481	corn crushers.....	238
series.....	482	sacking elevators.....	236
shunt.....	482	the selection of a.....	236
simple alternating-current.....	476	Feed pipe.....	353
Early forms.....	361	Feed pumps.....	452
Early history.....	298	Feed water heaters.....	334
Eccentric.....	372	forks.....	18
Economic considerations of wind-		hay stackers.....	179
mills.....	314	sweep rakes.....	178
Effect of increase of speed.....	294	Fire, banking the.....	355
Effect of length of working day.....	294	drawing the.....	356
Effectual tension on belt.....	28	Firing.....	354
Efficiency of dynamos.....	486	with soft coal.....	354
of a lamp.....	493	Float-feed carburetors.....	416
of a machine.....	12	Flues, the.....	351
thermal.....	26	cleaning the.....	359
of a wind wheel.....	307	Flywheels.....	410
Ejector, siphon or.....	330	Foaming.....	355
Electric bell.....	473	Force.....	10
Electric current, heating effect of	471	electromotive.....	455
Electrical energy.....	26	magnetic lines of.....	40
power.....	466	Force pumps.....	255
transmission.....	42	double pipe or underground... 255	
Electricity.....	462	Forks.....	181
current.....	464	Forms of motors.....	292
static.....	462	Four-cycle engines.....	452
Electromagnet.....	472	strokes of.....	403
Electromagnetic induction.....	472	Frame mounting.....	445
Electromotive force.....	466	Friction mounting.....	38
End-gate seeder.....	105	coefficient of.....	39
Energy.....	281	rolling.....	39
kinetic.....	282	Frog.....	57
law of transformation of.....	282	Fuels.....	347
potential.....	282	value of.....	348
sources of.....	281	Furley, M.....	56

	PAGE		PAGE
Fuse .....	471	Haying machinery, baling presses	187
Fusible plug .....	335, 336, 337	box presses.....	188
Future of the gasoline engine....	434	development.....	187
Gasoline engines, care.....	427	horse-power presses.....	188
construction.....	407	power presses.....	189
cooling .....	420	barn tools.....	181
four-cycle .....	402	development.....	181
future of.....	434	field stacking, machines for....	178
indicator diagram.....	423	forks.....	181
losses in.....	424	hay stackers.....	179
lubrication .....	427	sweep rakes.....	178
parts.....	403	hay loader.....	176
setting .....	431	development.....	176
strokes of.....	403	endless apron.....	177
testing .....	426	fork loader.....	177
troubles.....	428	the mower.....	162
action of valves.....	430	rakes.....	171
carburetion.....	430	hay tedders.....	174
compression.....	428	Heat.....	26
ignition.....	429	of combustion.....	349
two-cycle.....	404	latent.....	366
types of.....	402	of the liquid.....	366
wiring.....	419	Heaters, feed water.....	334
Gauge, steam.....	335, 336, 337, 352	Heating effect of an electric cur- rent.....	471
Gearing.....	37, 307	Heating of boxes.....	41
transmission.....	449	Heating surface, power by.....	341
Gears, reversing.....	378	Heel plate.....	70
compensating.....	451	Height and length.....	289
generation of steam.....	365	Hillside plow.....	65
Giddings's dynamometer.....	23	Hit-or-miss governors.....	411
Glass, water.....	353	Hock, width of.....	291
Goldswait, E.....	56	Hoe drill.....	110
Governors.....	385	Home-made windmills.....	299
automatic cut-off.....	389	battle-ax windmills.....	299
Corliss.....	391	Holland mills.....	299
hit-or-miss type.....	411	Jumbos.....	299
racing.....	388	merry-go-rounds.....	299
throttling.....	386, 411	mock turbines.....	299
Grate surface, power by.....	341	reconstructed turbines.....	299
Gray iron.....	44	Hooking up an engine.....	378
Grip.....	288	Horse, the.....	287
Guiding an engine.....	454	at work.....	291
Gutters.....	455	capacity of.....	292
Hammer test.....	346	grip.....	288
Handholes.....	351	height.....	289
Handling a boiler.....	351	length.....	289
Hand methods change to modern methods.....	1	maximum power of.....	293
Hand planters.....	121	resistance he can overcome....	288
Hand seeder.....	104	weight.....	288
Handy wagons.....	251	Horse power.....	466
Harrow, classification.....	82	brake.....	25
curved knife tooth.....	78	definition of.....	11
development.....	79	indicated.....	25, 425
disk.....	83	of belting.....	28
orchard disk.....	85	of shafting.....	38
smoothing.....	78	of steam engines.....	394
spading.....	84	Horse power presses.....	188
spring tooth.....	81	Howard, P. P.....	52
Harrow cart.....	82	Hot tube ignitor.....	417
Harvesting machinery.....	136	How the wind may be utilized... 315	315
combined harvester and thresher	154	Huskers and shredders.....	224
development.....	138, 139	Hydraulic test.....	346
modern harvester or binder....	143	Hysteresis.....	485
draft of binders.....	153	Ignition.....	429
Haying machinery.....	162	Ignitors.....	417

	PAGE		PAGE
Ignitors, contact spark.....	417	Link motion reverse.....	378
jump spark.....	418	Listers.....	132
Incandescent lamps.....	492	loose ground.....	133
Inclined plane.....	15	Locating dead center.....	375
Increase in production.....	2	Locomotive type.....	321
Increase in wages.....	3	Loss from improper amount of air	350
Incrustation.....	357	in a steam engine cylinder	368
Indicated horse power.....	425	in a gasoline engine.....	424
Indicator, steam and gas engine..	24	of motors.....	487
cards.....	25	Low water.....	357
Indicator diagram.....	382, 423	Lubricant, choice of.....	40
from a throttling-governed en-		Lubrication.....	40, 399, 427
gine.....	388	Lubricators.....	399
reading an.....	384	Machine, definition of.....	11
to read for pressures.....	385	Magnetic lines of force.....	460
Induction coil.....	496	direction of.....	460
Injector, the.....	332	Magnetic materials.....	461
Inside lap.....	369	Magnetic properties of coils.....	472
Insulation of an armature.....	458	Magneto alternator.....	478
Internal combustion engines.....	401	Magnets, artificial.....	460
early development.....	401	laws of.....	461
later development.....	402	natural.....	460
Internally fired boilers.....	320	Malleable link belting.....	33
Iron, cast.....	44	iron.....	44
chilled.....	44	Manholes.....	351
gray.....	44	Manure spreaders.....	191
malleable.....	44	development.....	192
white.....	44	drilling attachment.....	202
Jefferson, Thomas.....	53	sizes.....	202
Jointer.....	64	the modern.....	194
Joints, riveted.....	344	Materials.....	43
Joule.....	26	magnetic.....	461
Jumbos.....	299	strength of.....	46
Jump-spark ignitors.....	417	transverse strength of.....	46
Kilowatt.....	466	used.....	342
Labor of women.....	4	Maximum bending moment.....	46
Lamps, incandescent.....	492	Maximum power of the horse.....	293
commercial rating of.....	492	Mean effective pressure.....	25
Land roller.....	87	Mechanical efficiency.....	25
Landside.....	56	Mechanics, definition of.....	10
Lane, John.....	55	law of.....	12
Lap of valve.....	369	Merry-go-rounds.....	301
inside lap.....	369	Mills, power.....	316
object of lap.....	370	Mock turbine.....	299
outside lap.....	369	Modern planter.....	122
Lap joint, double-riveted.....	346	Modulus of rupture.....	47
single-riveted.....	344	Moldboard.....	56
Latent heat.....	365, 366	Moore, Gilpin.....	56
Law of electrical attraction and		Motors.....	281
repulsion.....	462	the animal as a.....	284
of magnets.....	461	comparison with a dynamo.....	487
of mechanics.....	12	counter electromotive force of.....	489
Ohm's.....	467	forms of.....	282
of resistance.....	466	losses of.....	489
of transformation of energy...	281	operating.....	489
Laying up a boiler.....	360	principle of.....	487
Lead.....	370	wire calculations for.....	495
reasons for.....	370	Mounting.....	437
Leaks.....	396	boiler.....	437
Length of belts.....	30	frame.....	445
Leveling the water column.....	353	rear.....	449
Lever.....	12	side.....	437
Lift pumps.....	263	under.....	444
Lightning and lightning rods.....	463	engine.....	446
Line of least draft.....	290	Moving an engine.....	453
Link belting.....	33	bridges.....	455

	PAGE		PAGE
Moving an engine, guiding.....	454	Plug, fusible.....	335, 336, 337
gutters.....	455	Polarization.....	470
mud holes.....	454	Poles.....	460
reversing.....	455	Poor regulation of voltage.....	486
Mowers.....	162	Pop valve, safety or.....	335, 336, 337
knife grinder.....	170	Population, percentage of, on the	
modern.....	164	farms.....	4
mower frame.....	165	Ports, anchor.....	313
one-horse.....	165	Potential difference.....	463
troubles with.....	169	distribution of, in lamp circuits	493
two-horse.....	165	unit of.....	464
wheels.....	166	Pounding.....	398
windrowing attachment.....	170	Power, boiler horse.....	340
Mudholes.....	454	definition of.....	11
Multipolar alternator.....	478	electrical.....	466
Muscles, strength of.....	286	by heating surface.....	341
Muscular development.....	284	horse power by test.....	340
Natural magnets.....	460	mills.....	235, 317
Newbold, Charles.....	54	alfalfa mills.....	237
Newcomen's engine.....	361	capacity of feed mills.....	237
Newton, Robert.....	56	corn crushers.....	238
Nut.....	16	presses.....	189
Object of lap.....	370	sacking elevators.....	236
Ohm.....	467	the selection of a feed mill.....	236
Ohm's law.....	467	Present engine, the.....	361
Oil.....	348	Pressure, mean effective.....	25
Oil-cooling system.....	423	Prime movers.....	281
On the road.....	456	Priming.....	339, 356
Open-bottom type, the.....	324	Principle of the commutator.....	479
Open-jacket cooling.....	423	Product, quality of.....	6
Operating motors.....	489	Production, cost of.....	5
Orchard disk harrow.....	85	increase in.....	4
Outside lap.....	369	Pulley, belt.....	32
Packing.....	397	definition of.....	16
Parallel connections.....	469	differential.....	16
Parallelogram of forces.....	10	rules for calculating speed.....	32
Parlin, William.....	35	Pumping machinery.....	256
Parts of a steam engine.....	361	centrifugal pumps.....	269
Physical and mental changes.....	3	early methods of raising water.....	256
Pipe, blow-off.....	338	force pumps.....	265
Piston.....	409	double-pipe or under force	
rings.....	409	pumps.....	265
Pitch of screw.....	16	hydraulic information.....	258
Plane, inclined.....	15	lift pumps.....	263
Planimeter, the.....	23	modern pumps.....	263
Planker.....	87	power pumps.....	268
Planter wheels.....	129	pump cylinders.....	267
Plow.....	52	pump principles.....	258
bottom.....	59	reciprocating pumps.....	257
chilled.....	65	rotary pumps.....	269
disk.....	66	Pumps, feed.....	330
the development of.....	52	Quality of products.....	6
draft of.....	72	Racing.....	388
gang.....	58	Rakes, development.....	171
hillside.....	65	endless-apron reversible.....	173
the modern sulky.....	58	one-way.....	173
the modern walking.....	56	self-dump.....	172
the Roman plow.....	52	side-delivery rakes.....	172
scouring of.....	71	steel dump or sulky.....	172
set of sulky.....	70	Ransom, Robert.....	53
set of walking.....	69	Rating.....	457
steam.....	67	Reading an indicator diagram.....	384
the steel plow.....	54	Rear mounting.....	440
subsoil.....	66	Reasons for lead.....	370
types of sulky plows.....	60	Reciprocating pumps.....	257
Plow-cut disk harrow.....	87	Reconstructed turbines.....	299

	PAGE		PAGE
Reducing motion.....	24	Setting engine, an.....	456
Reinforcements of plows.....	58	slide valve, the.....	376
Regulation, wind wheels.....	306	Shafting.....	38
of speed.....	458	Shape of a magnetic field about a	
Repairing a dynamo.....	657	current.....	464
Resistance.....	466	Share bar.....	38
comparative.....	467	hardening.....	72
laws of.....	467	sharpening steel.....	71
overcome by horse.....	288	slip.....	57
unit of.....	467	Shear.....	46
Return-flue boilers.....	324	Shears of a pulley.....	46
Reversing a simple slide-valve en-		Shin.....	56
gine.....	377	Shoe drill.....	111
Reversing the engine on the road	455	for wire rope.....	34
Reversing gears.....	378	Shunts.....	469
double-eccentric.....	378	Shunt dynamos.....	482
link motion.....	378	Side mounting.....	437
single-eccentric.....	380	Single-eccentric reverse gear....	380
Rheostats.....	468	Single-riveted lap joint.....	344
Right-hand rule.....	465	Siphon or ejector.....	330
Ring-armature direct-current dy-		Size of plows.....	58
namo.....	480	Sleds.....	254
Riveted joints.....	344	capacity.....	255
Rivets.....	342	selection of.....	254
Road rollers.....	453	Slide valve.....	369
Rods, stay.....	343	setting the.....	376
Rollers, land.....	87	Slip share.....	56
road.....	453	Small, James.....	52
Rope transmission.....	33	Smoke prevention.....	351
cotton.....	34	Smoothing harrow.....	78
hemp.....	34	Soft coal, firing with.....	354
manilla.....	34	Sources of energy.....	281
sheaves.....	34	Space, steam.....	340
splice.....	35	Spading harrow.....	85
wire.....	34	Spark arrester.....	339
Rotary pumps.....	269	Sparking at the commutator....	486
Rotating coils, currents induced		Speed, effect of increase of.....	294
in.....	475	Splice-rope.....	35
Round-bottom types.....	324	Spring-tooth harrow.....	81
Running the engine.....	396	Stackers.....	215
Sacking elevators.....	236	Starting the engine.....	395
Safety or pop valve.....	335, 336, 337, 352	Static electricity.....	462
Sanborn, J. W.....	73	Stay bolts.....	343
Saturated steam.....	366	Stay rods.....	343
Scouring of plows.....	71	Steam, expansion of.....	367
Screen, the.....	15	generation of.....	365
Section modulus.....	48	saturated.....	366
Seeders.....	102	superheated.....	366
classification of.....	104	total heat of.....	366
combination.....	110	volume and weight of.....	367
end-gate seeder, the.....	105	Steam boilers.....	317
hand seeder, the.....	104	classification of.....	318
wheelbarrow seeder, the.....	105	principle of.....	317
Selection of a sulky plow.....	75	Steam engine, classification of....	364
Self-exciting principle of dynamos	181	commercial rating of.....	394
Self feeder and band cutter.....	214	compound.....	392
Self induction.....	196	double-cylinder.....	391
Self-recording dynamometer.....	20	early forms.....	361
Semi-anthracite coal.....	348	hooking up.....	378
Separator or modern threshing		horse power.....	394
machine.....	206	leaks.....	396
Set of coulters.....	70	losses in cylinder.....	368
sulky plows.....	70	Newcomen's.....	361
walking plows.....	69	parts of.....	364
Setting double-eccentric valve,		present, the.....	361
the.....	379	reversing.....	377

	PAGE		PAGE
Steam engine, running.....	396	Traction .....	451
starting the.....	395	Traction dynamometer.....	19
stopping.....	396	Traction engines.....	436
Steam and gas engine indicators..	24	gasoline.....	456
Steam gauge.....335, 336, 337,	352	on the road.....	459
Steam plow.....	68	rating.....	457
Steel.....	342	regulation of speed.....	458
cast.....	45	traction.....	459
link belting.....	33	Transformers .....	498
mild and Bessemer.....	45	Transmission dynamometer.....	19
soft center.....	45	Transmission, electrical.....	42
tool.....	45	gearing.....	449
towers.....	313	of power.....	28
Stopping the engine.....	396	Tread power, the.....	295
Straw.....	348	the work of a horse in a.....	296
burners .....	328	Triangles.....	36
Strength of boilers.....	342	Troubles, gasoline engine.....	428
of the boiler shell.....	344	Turbine windmills .....	303
of materials.....	46	Tabular roller.....	89
table of.....	49	Two-cycle engine.....	404
of muscles.....	286	strokes of.....	404
Subsoil plow.....	66	Types of gasoline engines.....	402
Subsurface packer.....	90	Types of sulky plows.....	60
Suction.....	69	Under mounted boilers.....	444
Sulky plow.....	58	Unit of potential difference, volt	
Superheated steam.....	365	on.....	464
Supply tank.....	330	of resistance.....	466
Sweep powers .....	297	of work.....	11
Sweep rakes.....	178	Use of the windmill, the.....	303
Tackle.....	16	Value of fuels.....	348
Tank, supply.....	330	Valve.....	411
Tap.....	16	action of.....	430
Tension.....	46	balanced.....	373
Test of boilers for strength.....	346	double-ported.....	373
hammer.....	347	lap of.....	399
hydraulic.....	346	piston.....	374
Test, horse power by.....	340	safety or pop.....335, 336, 337,	352
Testing.....	426	setting the double-eccentric...379	
Tests of mills.....	309	slide.....	369
Thresher.....	154	Vector quantity.....	10
combined harvesters and thresh-		Vertical boilers.....	318
ers .....	154	Volts.....	27
Threshing machinery.....	203	Volt or unit of potential difference	464
bean and pea threshers.....	218	Voltmeter.....	466
clover hullers.....	219	Volume of air for combustion...350	
development.....	203	Volume and weight of steam.....	367
modern threshing machine or		Wages, increase of.....	3
separator.....	206	Wagons .....	240
attachments, threshing machine.	214	buggies and sleds.....	239
self feeder and hand cutter..214		capacity .....	246
stackers.....	215	development of .....	239
weighers.....	216	draft of.....	246
wind stacker or blower.....	215	handy wagons.....	251
Throttling governors.....386,	411	material.....	240
indicator diagram from.....	388	Water-cooled engines.....	420
principle of the.....	387	glass.....	353
Tillage, objects of.....	51	low.....	357
Tillage machinery.....	51	Water columns.....	334
American development of.....	53	leveling the.....	353
Tires, width of.....	452	Watts.....	27
Tongueless disk harrow.....	87	Webster's plow.....	53
Total heat of steam.....	366	Weigher threshing machine.....	216
Towers.....	311	Weight.....	288
height.....	315	Wheelbarrow seeder.....	105
steel.....	313	White iron.....	44
Trace, direction of.....	289	Width of hock.....	291

	PAGE		PAGE
Width of tires.....	452	Wind wheels, regulation.....	306
Windmills.....	298	Wire belt lacing.....	31
classification.....	303	Wire table, copper.....	498
development of present-day....	298	Wiring calculations for a motor..	494
early history.....	298	Women, labor of.....	4
economic considerations of.....	314	Wood, Jethro.....	54
erecting.....	313	Wood.....	43, 347
gearing.....	307	and cob burners.....	326
home-made.....	299	Wooden pumps.....	263
power.....	316	Work, best conditions for.....	293
tests of.....	309	definition of.....	10
turbine.....	303	division of.....	294
the use of the.....	303	the horse at.....	291
Wind stacker or blower.....	215	unit of.....	11
Wind wheels.....	304	Working day, length of.....	5
efficiency.....	307	effect of length of.....	294





# STANDARD BOOKS

PUBLISHED BY

## ORANGE JUDD COMPANY

NEW YORK

439-441 Lafayette Street

CHICAGO

Marquette Building

---

*BOOKS sent to all parts of the world for catalog price. Discounts for large quantities on application. Correspondence invited. Brief descriptive catalog free. Large illustrated catalog, six cents.*

---

### Soils

By CHARLES WILLIAM BURKETT, Director Kansas Agricultural Experiment Station. The most complete and popular work of the kind ever published. As a rule, a book of this sort is dry and uninteresting, but in this case it reads like a novel. The author has put into it his individuality. The story of the properties of the soils, their improvement and management, as well as a discussion of the problems of crop growing and crop feeding, make this book equally valuable to the farmer, student and teacher.

There are many illustrations of a practical character, each one suggesting some fundamental principle in soil management. 303 pages. 5½ x 8 inches. Cloth. . . . \$1.25

### Insects Injurious to Vegetables

By Dr. F. H. CHITTENDEN, of the United States Department of Agriculture. A complete, practical work giving descriptions of the more important insects attacking vegetables of all kinds with simple and inexpensive remedies to check and destroy them, together with timely suggestions to prevent their recurrence. A ready reference book for truckers, market-gardeners, farmers as well as others who grow vegetables in a small way for home use; a valuable guide for college and experiment station workers, school-teachers and others interested in entomology of nature study. Profusely illustrated. 5½ x 8 inches. 300 pages. Cloth. . . . . \$1.50

## The Cereals in America

By THOMAS F. HUNT, M.S., D.Agri., Professor of Agronomy, Cornell University. If you raise five acres of any kind of grain you cannot afford to be without this book. It is in every way the best book on the subject that has ever been written. It treats of the cultivation and improvement of every grain crop raised in America in a thoroughly practical and accurate manner. The subject-matter includes a comprehensive and succinct treatise of wheat, maize, oats, barley, rye, rice, sorghum (kafir corn) and buckwheat, as related particularly to American conditions. First-hand knowledge has been the policy of the author in his work, and every crop treated is presented in the light of individual study of the plant. If you have this book you have the latest and best that has been written upon the subject. Illustrated. 450 pages. 5½ x 8 inches. Cloth. . . . . \$1.75

## The Forage and Fiber Crops in America

By THOMAS F. HUNT. This book is exactly what its title indicates. It is indispensable to the farmer, student and teacher who wishes all the latest and most important information on the subject of forage and fiber crops. Like its famous companion, "The Cereals in America," by the same author, it treats of the cultivation and improvement of every one of the forage and fiber crops. With this book in hand, you have the latest and most up-to-date information available. Illustrated. 428 pages. 5½ x 8 inches. Cloth. . . . . \$1.75

## The Book of Alfalfa

History. Cultivation and Merits. Its Uses as a Forage and Fertilizer. The appearance of the Hon. F. D. COBURN'S little book on Alfalfa a few years ago has been a profit revelation to thousands of farmers throughout the country, and the increasing demand for still more information on the subject has induced the author to prepare the present volume, which is by far the most authoritative, complete and valuable work on this forage crop published anywhere. It is printed on fine paper and illustrated with many full-page photographs that were taken with the especial view of their relation to the text. 336 pages. 6½ x 9 inches. Bound in cloth, with gold stamping. It is unquestionably the handsomest agricultural reference book that has ever been issued. Price, postpaid . . . \$2.00

## Clean Milk

By S. D. BELCHER, M.D. In this book the author sets forth practical methods for the exclusion of bacteria from milk, and how to prevent contamination of milk from the stable to the consumer. Illustrated. 5 x 7 inches. 146 pages. Cloth. . . . . \$1.00

## Bean Culture

By GLENN C. SEVEY, B.S. A practical treatise on the production and marketing of beans. It includes the manner of growth, soils and fertilizers adapted, best varieties, seed selection and breeding, planting, harvesting, insects and fungous pests, composition and feeding value; with a special chapter on markets by Albert W. Fulton. A practical book for the grower and student alike. Illustrated. 144 pages. 5 x 7 inches. Cloth. . . . . \$0.50

## Celery Culture

By W. R. BEATTIE. A practical guide for beginners and a standard reference of great interest to persons already engaged in celery growing. It contains many illustrations giving a clear conception of the practical side of celery culture. The work is complete in every detail, from sowing a few seeds in a window-box in the house for early plants, to the handling and marketing of celery in carload lots. Fully illustrated. 150 pages. 5 x 7 inches. Cloth. . . . . \$0.50

## Tomato Culture

By WILL W. TRACY. The author has rounded up in this book the most complete account of tomato culture in all its phases that has ever been gotten together. It is no second-hand work of reference, but a complete story of the practical experiences of the best posted expert on tomatoes in the world. No gardener or farmer can afford to be without the book. Whether grown for home use or commercial purposes, the reader has here suggestions and information nowhere else available. Illustrated. 150 pages. 5 x 7 inches. Cloth. \$0.50

## The Potato

By SAMUEL FRASER. This book is destined to rank as a standard work upon Potato Culture. While the practical side has been emphasized, the scientific part has not been neglected, and the information given is of value, both to the grower and the student. Taken all in all, it is the most complete, reliable and authoritative book on the potato ever published in America. Illustrated. 200 pages. 5 x 7 inches. Cloth. . . . . \$0.75

## Dwarf Fruit Trees

By F. A. WAUGH. This interesting book describes in detail the several varieties of dwarf fruit trees, their propagation, planting, pruning, care and general management. Where there is a limited amount of ground to be devoted to orchard purposes, and where quick results are desired, this book will meet with a warm welcome. Illustrated. 112 pages. 5 x 7 inches. Cloth. . . . . \$0.50

## **Cabbage, Cauliflower and Allied Vegetables**

By C. L. ALLEN. A practical treatise on the various types and varieties of cabbage, cauliflower, broccoli, Brussels sprouts, kale, collards and kohlrabi. An explanation is given of the requirements, conditions, cultivation and general management pertaining to the entire cabbage group. After this each class is treated separately and in detail. The chapter on seed raising is probably the most authoritative treatise on this subject ever published. Insects and fungi attacking this class of vegetables are given due attention. Illustrated. 126 pages. 5 x 7 inches. Cloth. . . . . \$0.50

## **Asparagus**

By F. M. HEXAMER. This is the first book published in America which is exclusively devoted to the raising of asparagus for home use as well as for market. It is a practical and reliable treatise on the saving of the seed, raising of the plants, selection and preparation of the soil, planting, cultivation, manuring, cutting, bunching, packing, marketing, canning and drying insect enemies, fungous diseases and every requirement to successful asparagus culture, special emphasis being given to the importance of asparagus as a farm and money crop. Illustrated. 174 pages. 5 x 7 inches. Cloth. . \$0.50

## **The New Onion Culture**

By T. GREINER. Rewritten, greatly enlarged and brought up to date. A new method of growing onions of largest size and yield, on less land, than can be raised by the old plan. Thousands of farmers and gardeners and many experiment stations have given it practical trials which have proved a success. A complete guide in growing onions with the greatest profit, explaining the whys and wherefores. Illustrated. 5 x 7 inches. 140 pages. Cloth. . . . . \$0.50

## **The New Rhubarb Culture**

A complete guide to dark forcing and field culture. Part I—By J. E. MORSE, the well-known Michigan trucker and originator of the now famous and extremely profitable new methods of dark forcing and field culture. Part II—Compiled by G. B. FISKE. Other methods practiced by the most experienced market gardeners, greenhouse men and experimenters in all parts of America. Illustrated. 130 pages. 5 x 7 inches. Cloth. . . . . \$0.50

## **Alfalfa**

By F. D. COBURN. Its growth, uses and feeding value. The fact that alfalfa thrives in almost any soil; that without reseeded it goes on yielding two, three, four and sometimes five cuttings annually for five, ten or perhaps 100 years; and that either green or cured it is one of the most nutritious forage plants known, makes reliable information upon its production and uses of unusual interest. Such information is given in this volume for every part of America, by the highest authority. Illustrated. 164 pages. 5 x 7 inches. Cloth. \$0.50

## **Ginseng, Its Cultivation, Harvesting, Marketing and Market Value**

By MAURICE G. KAINS, with a short account of its history and botany. It discusses in a practical way how to begin with either seed or roots, soil, climate and location, preparation, planting and maintenance of the beds, artificial propagation, manures, enemies, selection for market and for improvement, preparation for sale, and the profits that may be expected. This booklet is concisely written, well and profusely illustrated, and should be in the hands of all who expect to grow this drug to supply the export trade, and to add a new and profitable industry to their farms and gardens without interfering with the regular work. New edition. Revised and enlarged. Illustrated. 5 x 7 inches. Cloth. . . . \$0.50

## **Landscape Gardening**

By F. A. WAUGH, professor of horticulture, University of Vermont. A treatise on the general principles governing outdoor art; with sundry suggestions for their application in the commoner problems of gardening. Every paragraph is short, terse and to the point, giving perfect clearness to the discussions at all points. In spite of the natural difficulty of presenting abstract principles the whole matter is made entirely plain even to the inexperienced reader. Illustrated. 152 pages. 5 x 7 inches. Cloth. . . . \$0.50

## **Hedges, Windbreaks, Shelters and Live Fences**

By E. P. POWELL. A treatise on the planting, growth and management of hedge plants for country and suburban homes. It gives accurate directions concerning hedges; how to plant and how to treat them; and especially concerning windbreaks and shelters. It includes the whole art of making a delightful home, giving directions for nooks and balconies, for bird culture and for human comfort. Illustrated. 140 pages. 5 x 7 inches. Cloth. . . . \$0.50

## Farm Grasses of the United States of America

By WILLIAM JASPER SPILLMAN. A practical treatise on the grass crop, seeding and management of meadows and pastures, description of the best varieties, the seed and its impurities, grasses for special conditions, lawns and lawn grasses, etc., etc. In preparing this volume the author's object has been to present, in connected form, the main facts concerning the grasses grown on American farms. Every phase of the subject is viewed from the farmer's standpoint. Illustrated. 248 pages. 5 x 7 inches. Cloth. . . \$1.00

## The Book of Corn

By HERBERT MYRICK, assisted by A. D. SHAMEL, E. A. BURNETT, ALBERT W. FULTON, B. W. SNOW and other most capable specialists. A complete treatise on the culture, marketing and uses of maize in America and elsewhere, for farmers, dealers and others. Illustrated. 372 pages. 5 x 7 inches. Cloth. . . . . \$1.50

## The Hop—Its Culture and Care, Marketing and Manufacture

By HERBERT MYRICK. A practical handbook on the most approved methods in growing, harvesting, curing and selling hops, and on the use and manufacture of hops. The result of years of research and observation, it is a volume destined to be an authority on this crop for many years to come. It takes up every detail from preparing the soil and laying out the yard to curing and selling the crop. Every line represents the ripest judgment and experience of experts. Size, 5 x 8; pages, 300; illustrations, nearly 150; bound in cloth and gold; price, postpaid, . . . . . \$1.50

## Tobacco Leaf

By J. B. KILBREW and HERBERT MYRICK. Its Culture and Cure, Marketing and Manufacture. A practical handbook on the most approved methods in growing, harvesting, curing, packing and selling tobacco, with an account of the operations in every department of tobacco manufacture. The contents of this book are based on actual experiments in field, curing barn, packing house, factory and laboratory. It is the only work of the kind in existence, and is destined to be the standard practical and scientific authority on the whole subject of tobacco for many years. 506 pages and 150 original engravings. 5 x 7 inches. Cloth. . . . . \$2.00









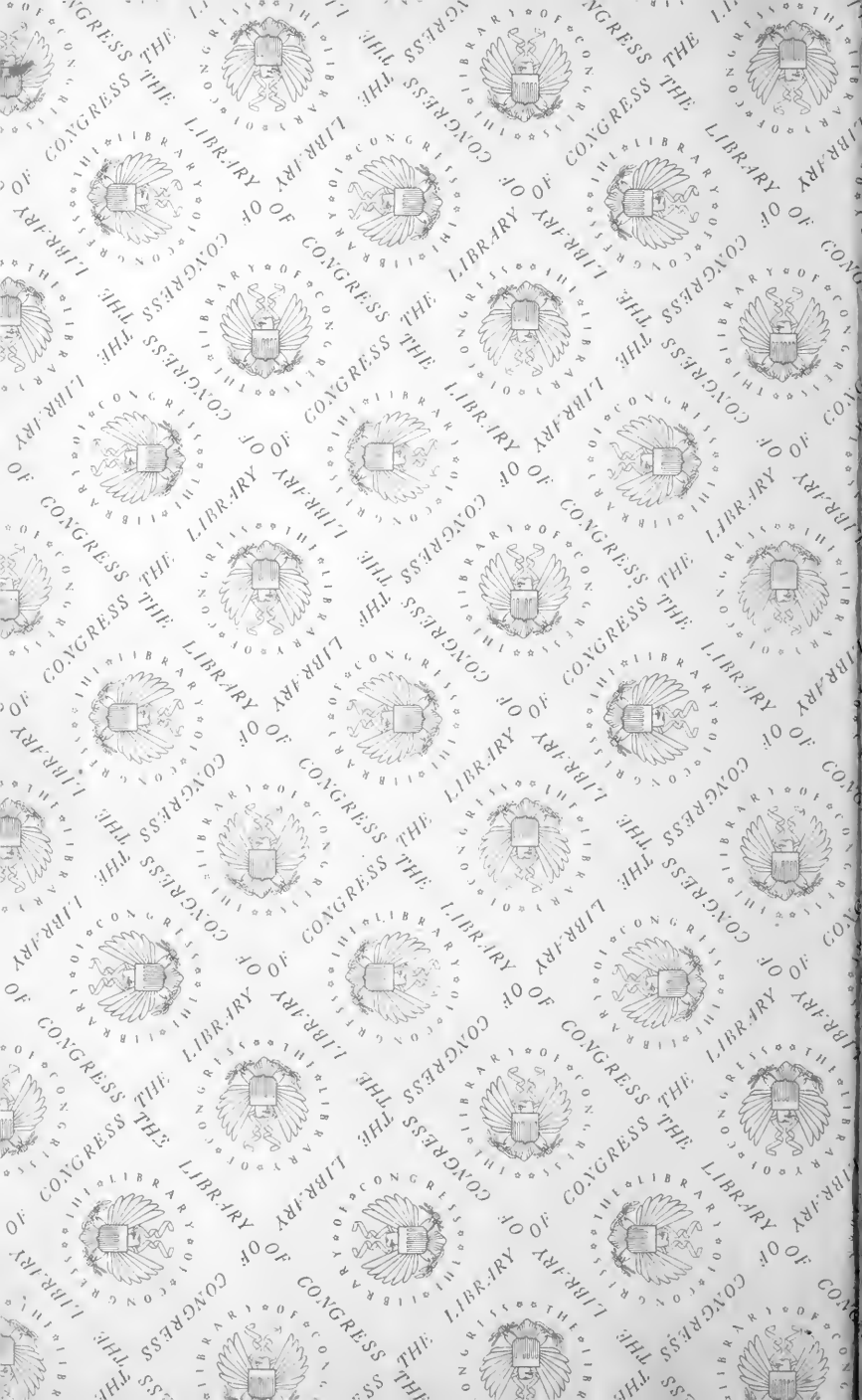



LIBRARY OF CONGRESS



00027572418